

THE FINIAL COMPANY™

January 2021 | Traverse Collection Catalog



THE FINIAL COMPANY™

introducing

R-TEC AUTOMATION® by Rowley®

unrivaled design

R-TEC Automation® products are meticulously designed to combine beauty, form and function with superior performance.

uncompromising quality & service

Our products have been designed and tested to meet the highest industry standards. We proudly stand behind our products by providing expert services to support you along with a motor backed by a 5 year warranty to protect your client's investment.

intuitive programming

R-TEC Smart Controls offer modern design and lifestyle options with easy programming and the ability to integrate with the latest smart home solutions. The R-TEC Automation® Hub and App solution is designed to control window treatments directly from a smartphone or mobile device and is easily integrated with voice control systems for a more personalized experience.

unsurpassed value

Provide your clients with innovative window treatment solutions that fit their budget expectations with R-TEC Automation® drapery and shade systems that offer unrivaled design, uncompromising quality and service, and intuitive control options at exceptional price points.

table of contents

NEW

motorized traverse systems

- R-TEC Automation® 1 3/8" metal 4
- R-TEC Automation® heavy duty 12
- Somfy® 18

fascia profiles 20 - 21

manual traverse systems

- 1 1/8" - 1 3/8" modern metal baton draw 24
- 1 3/8" metal baton draw 28
- heavy duty corded or baton draw 34

display boards 42

terms & conditions 43



1³/₈" motorized modern metal and metal traverse systems



R-TEC AUTOMATION®

motorized metal traverse **NEW**

Motorize 1³/₈" Modern Metal and Metal traverse systems, creating smart design solutions for both residential and commercial environments.

The slim drapery motor is designed to install seamlessly behind the drapery panel with quiet start / stop operation, the ability to easily charge without having to remove the motor and up to 500 open and close cycles per charge, providing the ultimate integrated functionality without compromising the look of your window treatment.

Coordinates with 1³/₈" Modern Metal and Metal Collection finials and finishes.

Choose from any of our 50 standard hand painted finishes located on page 34 or your own custom finish.



R-TEC AUTOMATION®

R-TEC smart controls **NEW**

The R-TEC Automation® Hub and App integration allow draperies to be controlled directly from a smartphone or integrated device while at home or away. Now available in the Apple® App store or Google Play™, search for Rowley to find and download the new R-TEC Automation® App.

As an alternative, remotes and wall switches allow for individual, group and all control for a customized solution with 1, 5 and 15 channel options.

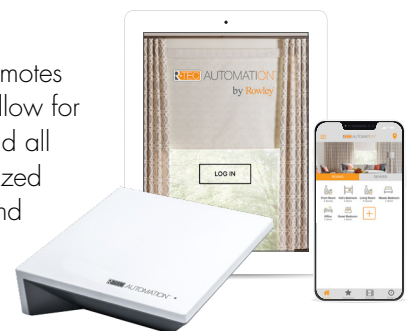

For more R-TEC Automation® window solution options, visit the Rowley Company website to view our compatible shade systems at: bit.ly/R-TEC-Automation-Shades

motorized metal traverse NEW

LI-ION BATTERY OR 110v AC POWER, RIPPLEFOLD OR PINCH PLEAT

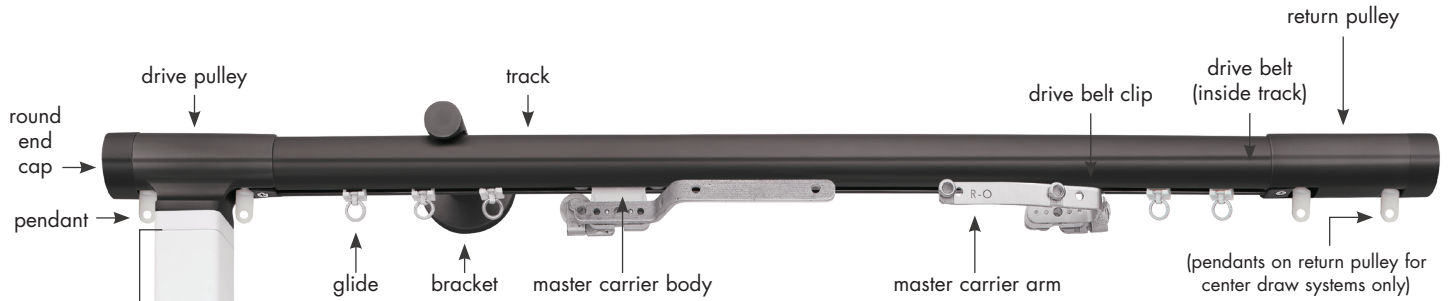

INCLUDED IN SYSTEM: R-TEC AUTOMATION® METAL TRAVERSE TRACK(S), ROUND METAL END CAPS, BRACKETS, COMPONENTS, MOTOR(S), POWER OPTION(S) & 5 CHANNEL HANDHELD REMOTE WITH WALL MOUNT

R-TEC Automation® slim drapery motor

- slim motor, 1 per metal traverse track
- maximum drapery weight: 77 lbs
- maximum track length: 24'
- power option: li-ion battery (includes battery charger & USB cable) or 110v AC power transformer (includes 10' cord with 3 conductor male plug)
- motor can be mounted on right or left for center draw
- available in white
- 5 year warranty



R-TEC Automation® handheld remote with wall mount

- (5 channel)
- 4¾"H x 2"W x ¾"D
 - 1 remote control per system
 - range: 65'
 - programmable Favorite Position to set your favorite drapery position
 - available in off-white

R-TEC metal traverse track

- track sold in 1 foot increments, 4' minimum
- maximum continuous length is 12' (select finishes); spliced lengths up to 24' (maximum of 2 splices per metal traverse track system)
- available in all finishes shown on page 9

motor & power options

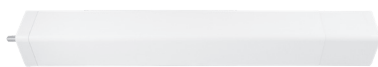

RTMLDSS50
slim drapery motor



RTMLDSSB
li-ion battery



RTMLDSSBC
battery charger



RTMLDSSUSB
USB charger cable



RTMDSSPT
110v AC power transformer 10' (plug included)

features



2-way RF communication

integrated radio frequency control allows for easy programming of individual, group or all control across window treatments



adjustable speed

choose from three options to customize the open / close speed of the drapery treatment



preferred open / close limit settings

electronic "autoset" limits accurately program preferred open and close limit settings



favorite position

allows a most used or favorite position to be set between open and close limit settings



obstruction detection

if the drapery motion is obstructed while the motor is running, the motor stops automatically to prevent damage



manual override

permits the drapery to be adjusted manually without the use of a remote or in the event of a power outage



quiet operation

powerful, smooth and quiet operation suitable for both residential and commercial environments

motorized metal traverse NEW

LHON BATTERY OR 110v AC POWER, RIPPLEFOLD OR PINCH PLEAT
AVAILABLE IN 1 3/8" DIAMETER

single



single traverse system, wall mount
• wall bracket: 3 1/2" or 6" return options

double



double traverse system, wall mount
• wall bracket: 3" and 7 1/2" returns



single traverse system, ceiling mount
• ceiling bracket: 2 3/8" drop

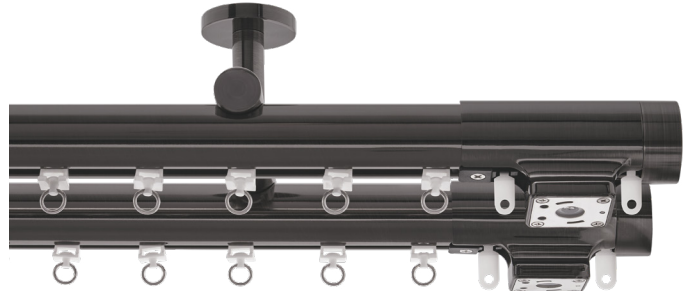

double traverse system, ceiling mount
• ceiling bracket: 2 5/8" drop, 4 1/2" apart



single traverse system, ceiling mount
• low-profile ceiling bracket: 5/32" drop



TFCM138191

- round end caps included
- see below for other end cap options and finial designs to coordinate with your motorized metal traverse system

finials

modern metal 1 3/8" collection

See pages 4 - 6 of the 2018 Drapery Hardware Catalog and website for more information on coordinating finial options. Finials require cuffs or collars to be used with tracks.



end caps

Round End Caps included; order our Bex End Cap pictured for an alternative look.



finials

Modern Metal Collection finials are designed to coordinate 1 3/8" motorized traverse systems.



cuffs & collars

Modern Collection finials coordinate with 1 3/8" cuffs and collars. Select a cuff or collar in any modern finish to attach the finial to your traverse system.

metal 1 3/8" collection

See page 11 of the 2018 Drapery Hardware Catalog and website for more information.



end caps

Round End Caps included; order our Wells End Cap pictured for a more stylized look.



finials

Select from 8 finial designs.

R-TEC smart controls NEW

motorized traverse



R-TEC Automation® App
Our App enables simple, intuitive control and system configuration from your smartphone or tablet.

Free app for iOS and Android



RTMHUB2
R-TEC Hub, 2-way RF; Wi-Fi built in
• 4½"H x 1¼"W x 4½"D
• range: 60'

Pair the R-TEC Hub and App with these systems (not sold by Rowley):



these additional accessories are available for purchase separately



RTMHR1C
handheld remote with wall mount, 1 channel
• 5 5/16"H x 1 1/4"W x 1/2"D
• range: 65'
• available in white



RTMHR5C
handheld remote with wall mount, 5 channel
• 4 3/4"H x 2"W x 3/8"D
• range: 65'
• available in off-white



RTMHR15C
handheld remote with wall mount, 15 channel
• 5 3/16"H x 1 1/4"W x 1/2"D
• range: 65'
• available in white



RTMWSR5C
surface mount wall switch 5 channel
• 4 1/2"H x 2 3/4"W x 7/8"D
• range: 65'
• available in white



RTMWSR15C
wall box mount switch 15 channel
• 4 1/2"H x 2 3/4"W x 1"D
• range: 65'
• available in white



RTMISS
interior sun sensor
• 1 3/4"H x 1 3/4"W x 5/8"D
• range: 65'
• available in white



RTMUSR
ARC USB signal repeater
• 2"L x 2 1/2"L with USB x 1 5/16"W
• extends the wireless range of the R-TEC Hub and remotes up to 60'
• maximum 2 repeaters per system or network
• available in white (color may vary)



RTMLWCW
wall charger for USB signal repeater
• 1 1/16"W x 1 11/16"L
• available in white (color may vary)



RTMSOLAR2
solar panel battery charger
• 4 5/8"H x 12 3/16"W x 1 3/8"D
• includes h-bracket, cables & fastener



motorized traverse

RTEC AUTOMATION®

carriers NEW

COMPONENTS ARE WHITE; TO ORDER COMPONENTS IN BRONZE, ADD /BR



- RTTFC138MCB**
RTTFC138MCB/BR
master carrier body
- select from different arms to assemble into one master carrier body
 - order two if ordering center draw master carrier arms - sold separately
 - available in white or bronze



- RTTFC138CD**
master carrier arms
- stainless steel overlap arms
 - pair
 - pinch pleat or Ripplefold
 - order two master carrier bodies - sold separately



- RTTFC138PPOR**
RTTFC138PPOL
pinch pleat master carrier arm
- stainless steel arm
 - right (R) or left (L)
 - pinch pleat
 - order one master carrier body - sold separately



- RTMDTCDB**
Ripplefold butt master carrier arms
- stainless steel arms with snaps to accept Ripplefold tape
 - pair
 - Ripplefold
 - butt master carriers do not overlap, allowing some light to filter between draperies on center draw treatments
 - butt master carriers must be specified for substitution
 - order two master carrier bodies - sold separately



- RTTFC138OBR**
RTTFC138OBL
Ripplefold butt master carrier arm
- stainless steel arm with snaps to accept Ripplefold tape
 - right and left
 - Ripplefold
 - butt master carriers do not overlap, allowing some light to filter between draperies on center draw treatments
 - butt master carriers must be specified for substitution
 - order one master carrier body - sold separately

master carrier body, available in white or bronze, is required for each master carrier arm - sold separately



- CP40** **CP40/BR**
pinch pleat glide
- available in white or bronze

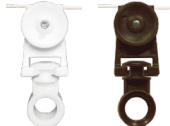

- R4060** | **R4060/BR** 60% fullness
R4080 | **R4080/BR** 80% fullness
R4100 | **R4100/BR** 100% fullness
R4120 | **R4120/BR** 120% fullness
- Ripplefold roller glide
- Ripplefold glides with detachable pendants
 - fullness 60%, 80%, 100% or 120%
 - available in white or bronze



- BT4333**
glide stop
- stainless steel

component colors

	White	Bronze
Master Carrier Body	•	•
Glides	•	•

brackets

EASY TO INSTALL - ATTACH TO TRACK WITH A SET SCREW



- TFCMT138400**
1 3/8" metal wall bracket, single
3 1/2" return, 2 7/16" Dia backplate



- TFCMT138402**
1 3/8" metal wall bracket, double
7 1/2" front and 3" back return, 2 7/16" Dia backplate



- TFCMT138404**
1 3/8" metal ceiling bracket, double
2 5/8" drop, 4 1/2" apart, 1 7/8" Dia ceiling plate

- TFCMT138401**
1 3/8" metal wall bracket, single
6" return, 2 7/16" Dia backplate



- TFCMT138403**
1 3/8" metal ceiling mount bracket
2 3/8" drop, 1 7/8" Dia ceiling plate



- TFCMT138405**
1 3/8" metal ceiling bracket extender
2" drop



- TFCMT138406**
1 3/8" low profile metal ceiling bracket
5/32" drop



- TFCMT138407**
connector/splice
3" L

finishes

1 3/8" modern metal



CH Chrome



BN Brushed Nickel



SG Satin Gold



BBN Brushed Black
Nickel

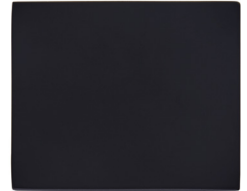

MK Matte Black

- maximum continuous track length in CH and SG is 8', all other finishes available up to 12'
- center draw tracks can be spliced for longer lengths up to 24', see order form on pages 10 - 11 for details

1 3/8" metal



PN Polished Nickel



AP Antique Pewter



AB Antique Brass



BZ Brushed Bronze



ORB Oil Rubbed
Bronze



SK Satin Black



MK Matte Black
coordinates with
VZ & DRB finials



VZ

DRB

- maximum continuous track length in BZ and ORB is 8', all other finishes available up to 12'
- center draw tracks can be spliced for longer lengths up to 24', see order form on pages 10 - 11 for details
- Matte Black (MK) tracks and brackets coordinate with Venetian Bronze (VZ) and Dark Oil Rubbed Bronze (DRB) finials

custom finishes

our 1 3/8" R-TEC Automation® metal traverse is also available in any of our 50 beautifully hand painted standard finishes located on the back cover of the 2018 Drapery Hardware Catalog or your own custom finish; please see retail price list for standard and custom finish surcharges

motorized traverse

how to order your 1 3/8" motorized metal traverse system in 5 easy steps

1 SELECT YOUR TRAVERSE SYSTEM

WALL MOUNT



single traverse wall mount

return choice:

3 1/2"

6"



double traverse wall mount

CEILING MOUNT



single traverse ceiling mount



single traverse ceiling clip

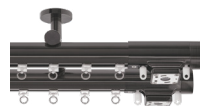

double traverse ceiling mount

2 SELECT A TRACK WIDTH AND FINISH

MODERN METAL TRAVERSE

	1 3/8" Dia	Track Cut Length (in.)	Max. Length
CH Chrome	<input type="checkbox"/>		192" Center 96" One-Way
BN Brushed Nickel	<input type="checkbox"/>		288" Center 144" One-Way
SG Satin Gold	<input type="checkbox"/>		192" Center 96" One-Way
BBN Brushed Black Nickel	<input type="checkbox"/>		288" Center 144" One-Way
MK Matte Black	<input type="checkbox"/>		288" Center 144" One-Way

METAL TRAVERSE

	1 3/8" Dia	Track Cut Length (in.)	Max. Length
PN Polished Nickel	<input type="checkbox"/>		288" Center 144" One-Way
AP Antique Pewter	<input type="checkbox"/>		288" Center 144" One-Way
AB Antique Brass	<input type="checkbox"/>		288" Center 144" One-Way
BZ Brushed Bronze	<input type="checkbox"/>		192" Center 96" One-Way
ORB Oil Rubbed Bronze	<input type="checkbox"/>		192" Center 96" One-Way
MK Matte Black*	<input type="checkbox"/>		288" Center 144" One-Way
SK Satin Black	<input type="checkbox"/>		288" Center 144" One-Way

*Coordinates with Venetian Bronze (VZ) and Dark Oil Rubbed Bronze (DRB) finials.

3 SELECT YOUR DRAPERY STYLE



PINCH PLEAT

overlap



RIPPLEFOLD

overlap

butt master

60% 80% 100% 120% fullness

4 COMPLETE YOUR TRAVERSE SPECIFICATIONS

Power Options:

Li-ion Battery (includes battery charger & USB cable)

110v AC Power Transformer (includes 10' cord with 3 conductor male plug)

Additional Power Options Sold Separately:

Solar Panel Charger
(includes hbracket, cables & fastener)

Additional Power Options Sold Separately:

110v AC Power Transformer (includes 30' cord, requires plug below)
 3 Conductor Male Plug

Direction:

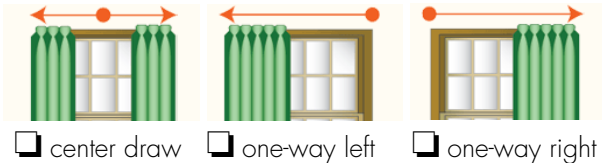

Component Colors:

White Bronze

	White	Bronze
Master Carrier Body	•	•
Glides	•	•

5 ADD ON FINIALS, CUFFS OR COLLARS must be selected with finials

MODERN METAL TRAVERSE

	finial	finial finish	metal modern cuff	metal modern collar	metal transitional collar	cuff/collar finish
TFCM600 Bryant	<input type="checkbox"/>		<input type="checkbox"/>	<input type="checkbox"/>	<input type="checkbox"/>	
TFCM600/CL Bryant Acrylic	<input type="checkbox"/>	-	<input type="checkbox"/>	<input type="checkbox"/>	<input type="checkbox"/>	
TFCM601 Declan	<input type="checkbox"/>		<input type="checkbox"/>	<input type="checkbox"/>	<input type="checkbox"/>	
TFCM601/CL Declan Acrylic	<input type="checkbox"/>	-	<input type="checkbox"/>	<input type="checkbox"/>	<input type="checkbox"/>	
TFCM602 Upton	<input type="checkbox"/>		<input type="checkbox"/>	<input type="checkbox"/>	<input type="checkbox"/>	
TFCM602/CL Upton Acrylic	<input type="checkbox"/>	-	<input type="checkbox"/>	<input type="checkbox"/>	<input type="checkbox"/>	
TFCM603 Delano	<input type="checkbox"/>		<input type="checkbox"/>	<input type="checkbox"/>	<input type="checkbox"/>	
TFCM604 Mercer	<input type="checkbox"/>		<input type="checkbox"/>	<input type="checkbox"/>	<input type="checkbox"/>	
TFCM605 Luca	<input type="checkbox"/>		<input type="checkbox"/>	<input type="checkbox"/>	<input type="checkbox"/>	
TFCM606 Stiles	<input type="checkbox"/>		<input type="checkbox"/>	<input type="checkbox"/>	<input type="checkbox"/>	
TFCM691 Anson	<input type="checkbox"/>		<input type="checkbox"/>	<input type="checkbox"/>	<input type="checkbox"/>	
TFCM691/CL Anson Acrylic	<input type="checkbox"/>	-	<input type="checkbox"/>	<input type="checkbox"/>	<input type="checkbox"/>	
TFCM692 Eason	<input type="checkbox"/>		<input type="checkbox"/>	<input type="checkbox"/>	<input type="checkbox"/>	
TFCM692/CL Eason Acrylic	<input type="checkbox"/>	-	<input type="checkbox"/>	<input type="checkbox"/>	<input type="checkbox"/>	
TFCM138690 Bex 1 ³ / ₈ " End Cap	<input type="checkbox"/>		-	-	-	-

METAL TRAVERSE

	finial	finial finish
TFCM138100 Turner	<input type="checkbox"/>	
TFCM138101 Britton	<input type="checkbox"/>	
TFCM138102 Ashby	<input type="checkbox"/>	
TFCM138103 Abington	<input type="checkbox"/>	
TFCM138104 Harlow	<input type="checkbox"/>	
TFCM138105 Weston	<input type="checkbox"/>	
TFCM138106 Brentford	<input type="checkbox"/>	
TFCM138107 Rothwell	<input type="checkbox"/>	
TFCM138190 Wells End Cap	<input type="checkbox"/>	

motorized heavy duty traverse systems



R-TEC AUTOMATION®

motorized heavy duty traverse **NEW**

R-TEC Automation® heavy duty traverse systems combine style and function with smart design solutions for both residential and commercial environments.

The slim drapery motor is designed to install seamlessly behind the drapery panel with quiet start / stop operation, the ability to easily charge without having to remove the motor and up to 500 open and close cycles per charge, providing the ultimate integrated functionality without compromising the look of your window treatment.

Available with 1 3/8", 1 7/8", 2", 2 1/4" and 3" diameter fascia profiles or without wood fascia.

Choose from any of our 50 standard hand painted finishes located on page 34 or your own custom finish.



R-TEC AUTOMATION®

R-TEC smart controls **NEW**

The R-TEC Automation® Hub and App integration allow draperies to be controlled directly from a smartphone or integrated device while at home or away. Now available in the Apple® App store or Google Play™, search for Rowley to find and download the new R-TEC Automation® App.

As an alternative, remotes and wall switches allow for individual, group and all control for a customized solution with 1, 5 and 15 channel options.



For more R-TEC Automation® window solution options, visit the Rowley Company website to view our compatible shade systems at: bit.ly/R-TEC-Automation-Shades

motorized heavy duty NEW

LHON BATTERY OR 110v AC POWER, RIPPLEFOLD OR PINCH PLEAT

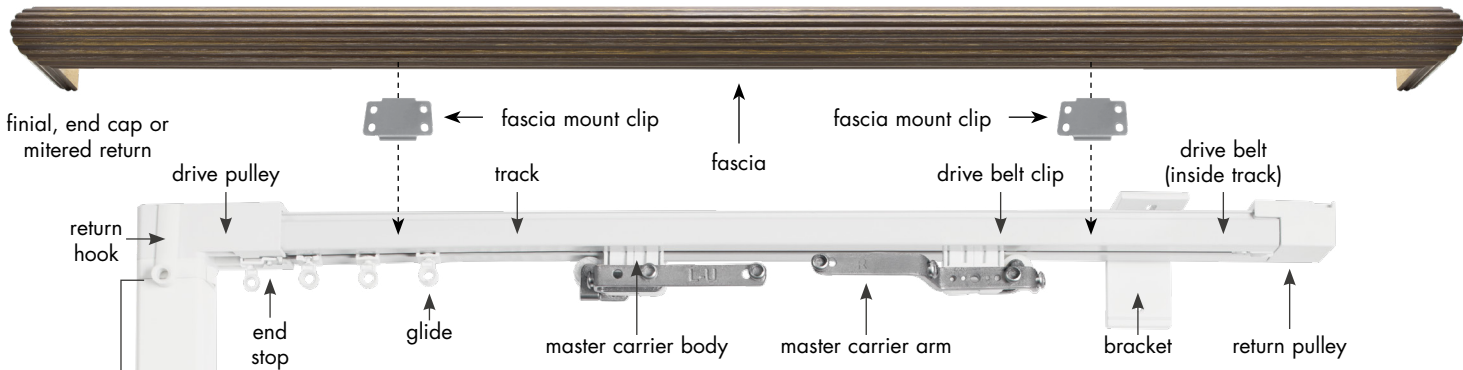

INCLUDED IN SYSTEM: R-TEC AUTOMATION® TRACK(S), BRACKETS, COMPONENTS, MOTOR(S), POWER OPTION(S) & 5 CHANNEL HANDHELD REMOTE WITH WALL MOUNT

system requirements:
1 drive pulley & 1 return pulley for one-way draw;
2 drive pulleys for center draw.

slim drapery motor* (can be top mounted)

R-TEC Automation® slim drapery motor

- slim drapery motor, 1 per track
- maximum drapery weight: 110 lbs
- maximum track length: 36'
- power option: li-ion battery (includes battery charger & USB cable) or 110v AC power transformer (includes 10' cord with 3 conductor male plug)
- motor can be mounted on right or left for center draw, or top mounted
- return hooks/snaps included; available in white or bronze
- available in white
- 5 year warranty



R-TEC Automation® handheld remote with wall mount (5 channel)

- 4 3/4" H x 2" W x 3/8" D
- 1 remote control per system
- range: 65'
- programmable Favorite Position to set your favorite drapery position
- available in off-white

li-ion battery shown (110v AC power transformer option available)

R-TEC Automation® track

- track sold in 1 foot increments, 4' minimum
- maximum continuous length is 19'; spliced lengths up to 36'
- available in white or bronze
- may be ordered with or without fascia
- fascia options shown on pages 20-21

*Tandem alternative option: see page 17 of the price list for details.

motor & power options



RTMLDSS50 slim drapery motor

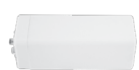

RTMLDSSB li-ion battery



RTMLDSSBC battery charger



RTMLDSSUSB USB charger cable



RTMDSSPT 110v AC power transformer 10' (plug included)

features



2-way RF communication

integrated radio frequency control allows for easy programming of individual, group or all control across window treatments



adjustable speed

choose from three options to customize the open / close speed of the drapery treatment



preferred open / close limit settings

electronic "autoset" limits accurately program preferred open and close limit settings



favorite position

allows a most used or favorite position to be set between open and close limit settings



obstruction detection

if the drapery motion is obstructed while the motor is running, the motor stops automatically to prevent damage



manual override

permits the drapery to be adjusted manually without the use of a remote or in the event of a power outage



quiet operation

powerful, smooth and quiet operation suitable for both residential and commercial environments

motorized heavy duty NEW

LHON BATTERY OR 110v AC POWER, RIPPLEFOLD OR PINCH PLEAT

single



single traverse system with fascia

double



double traverse system with fascia (front fascia shown; front and back fascia also available)



single traverse system with mitered returns

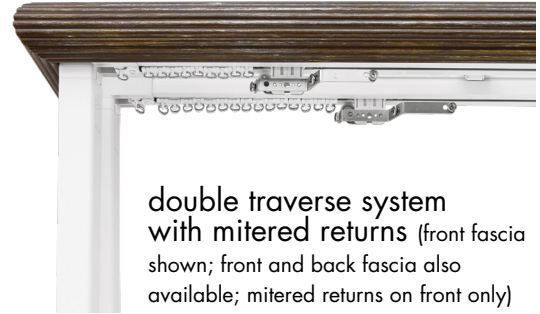

double traverse system with mitered returns (front fascia shown; front and back fascia also available; mitered returns on front only)



single traverse system without fascia

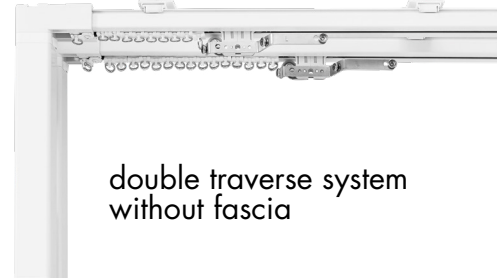

double traverse system without fascia

coordinating fascia profiles & finials

For more details on fascia options, see pages 20-21. Finials sold separately. Please reference the 2018 Drapery Hardware Catalog for coordinating finials: 1 3/8" Dia on pages 62-64, 2" - 2 1/4" Dia on pages 69-76 and 3" Dia on pages 82-84.



slim round smooth, no finials
• 1 7/8" Dia



flat smooth, no finials
• 2 1/4" Dia



smooth
• 1 3/8", 2", 2 1/4" and 3" Dia



grooved
• 1 3/8", 2", 2 1/4" and 3" Dia



fluted
• 1 3/8", 2" and 2 1/4" Dia



reeded
• 1 3/8", 2", 2 1/4" and 3" Dia



wide reeded
• 2 1/4" Dia



mitered returns (sold separately)
• 1 3/8", 1 7/8", 2", 2 1/4" and 3" Dia
• all profiles

R-TEC smart controls NEW

motorized traverse



R-TEC Automation® App
Our App enables simple, intuitive control and system configuration from your smartphone or tablet.

Free app for iOS and Android



RTMHUB2
R-TEC Hub, 2-way RF; Wi-Fi built in

- 4½"H x 1¼"W x 4½"D
- range: 60'

Pair the R-TEC Hub and App with these systems (not sold by Rowley):



these additional accessories are available for purchase separately



RTMHR1C
handheld remote with wall mount, 1 channel

- 5 5/16"H x 1 1/4"W x 1/2"D
- range: 65'
- available in white



RTMHR5C
handheld remote with wall mount, 5 channel

- 4 3/4"H x 2"W x 3/8"D
- range: 65'
- available in off-white



RTMHR15C
handheld remote with wall mount, 15 channel

- 5 3/16"H x 1 1/4"W x 1/2"D
- range: 65'
- available in white



RTMWSR5C
surface mount wall switch 5 channel

- 4 1/2"H x 2 3/4"W x 7/8"D
- range: 65'
- available in white



RTMWSR15C
wall box mount switch 15 channel

- 4 1/2"H x 2 3/4"W x 1"D
- range: 65'
- available in white



RTMISS
interior sun sensor

- 1 3/4"H x 1 3/4"W x 5/8"D
- range: 65'
- available in white



RTMUSR
ARC USB signal repeater

- 2"L x 2 1/2"L with USB x 1 5/16"W
- extends the wireless range of the R-TEC Hub and remotes up to 60'
- maximum 2 repeaters per system or network
- available in white (color may vary)



RTMLWCW
wall charger for USB signal repeater

- 1 7/16"W x 1 13/16"L
- available in white (color may vary)



RTMSOLAR2
solar panel battery charger

- 4 5/8"H x 12 5/16"W x 1 3/8"D
- includes hbracket, cables & fastener

motorized traverse

RTEC AUTOMATION®

carriers NEW

COMPONENTS ARE WHITE; TO ORDER COMPONENTS IN BRONZE, ADD /BR

master carrier body, available in white or bronze, is required for each master carrier arm - sold separately



- RTMDTMCB RTMDTMCB/BR**
master carrier body
- select from different arms to assemble into one master carrier body
 - order two if ordering center draw master carrier arms - sold separately
 - pinch pleat or Ripplefold
 - available in white or bronze



- RTMDTCD**
master carrier arms for center draw
- RTMDTCDTAN**
tandem master carrier arms for center draw
- stainless steel overlap arms
 - pair
 - for use with center opening draperies
 - pinch pleat or Ripplefold
 - order two master carrier bodies - sold separately



- RTMDTOR RTMDTOL**
master carrier arm for one-way draw
- stainless steel arm
 - right (R) or left (L)
 - for use with one-way opening draperies
 - pinch pleat or Ripplefold
 - order one master carrier body - sold separately



- RTMDTCDB**
Ripplefold butt master carrier arms for center draw
- stainless steel arms with snaps to accept Ripplefold tape
 - pair
 - for use with center opening draperies
 - Ripplefold
 - butt master carriers do not overlap, allowing some light to filter between draperies on center draw treatments
 - order two master carrier bodies - sold separately



- RTMDTOB**
Ripplefold butt master carrier arm for one-way draw
- stainless steel arms
 - right and left
 - for use with one-way opening draperies
 - Ripplefold
 - order one master carrier body - sold separately



- CP40 CP40/BR**
pinch pleat glide
- available in white or bronze

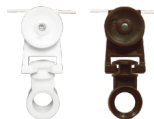

- R4060 R4060/BR** 60% fullness
R4080 R4080/BR 80% fullness
R4100 R4100/BR 100% fullness
R4120 R4120/BR 120% fullness
Ripplefold roller glide
- Ripplefold glides with detachable pendants
 - fullness 60%, 80%, 100% or 120%
 - available in white or bronze



- BT4333**
glide stop
- stainless steel

component colors

	White	Bronze
Track	•	•
Master Carrier Body	•	•
Glides	•	•
Brackets	•	•

brackets

EASY CLICK INSTALLATION



- TB035-R**
wall traverse bracket, single
- adjustable 3½" - 4½" return
 - 2½" H x 1½" W backplate
 - available in white or bronze /BR



- TB060-R**
wall traverse bracket, single or double
- adjustable 5½"-6¼" front return
 - adjustable 2½"-3½" back return
 - 3¾" H x 1¾" W backplate
 - available in white or bronze /BR



- TB100-R**
wall traverse bracket, single, double or triple
- adjustable up to 10"
 - 4½" H x 1½" W backplate
 - available in white or bronze /BR



- RTMDTBCM**
single ceiling mount clip
- 1⅜" H x 2 ¼" Deep x 1" W
 - may only be used in systems without fascia
 - single bracket; may be substituted in single or double systems
 - available in white or bronze /BR

for double ceiling mount installation, install two brackets into ceiling



- CP500**
drapery return bracket
- 1¾" return
 - ¾" H x ½" W backplate
 - allows for return on track hardware in traverse systems; included
 - available in zinc



- RTMDTFC**
fascia mount clip
- use to attach fascia to traverse systems; included
 - available in zinc



- CMTB-R**
steel custom ceiling bracket, single
2¾" H x 1½" W backplate
- specify drop: contingent upon which fascia or finials are chosen
- for double ceiling mount installation, install two individual brackets into ceiling



- TBKT214-R TBKT300-R**
- 3½" H x ¾" W backplate, 7⅞" or 8¾" front return and 3" back track return*
 - use to combine 2", 2¼" or 3" full wood pole with single traverse systems
 - includes traverse ceiling mount bracket attached onto the bottom of the overbracket
 - fascias sold separately
 - available in any of our 50 standard hand painted finishes on page 34 or your own custom finish

*for custom bracket returns, see page 56 of the 2018 Drapery Hardware Catalog

motorized traverse systems

motorized traverse

R-TEC AUTOMATION® OR SOMFY® MOTORS

R-TEC Automation®

Provide your clients with innovative window treatment solutions that fit their budget expectations with R-TEC Automation® systems that offer unrivaled design, uncompromising quality and service, and intuitive control options at exceptional price points.



R-TEC AUTOMATION® by Rowley

R-TEC Automation® system features:

- max. drapery weight: 110 lbs. slim motor
- track sold in 1 foot increments, 4' minimum
- maximum continuous length is 19'
- spliced lengths up to 36' with slim drapery motor
- 5 channel handheld remote with wall mount per system
- li-ion battery or 110v AC power transformer 10'
- optional solar power battery charger
- programmable Favorite Position
- app R-TEC Automation® available on the Apple® App Store or Google Play™

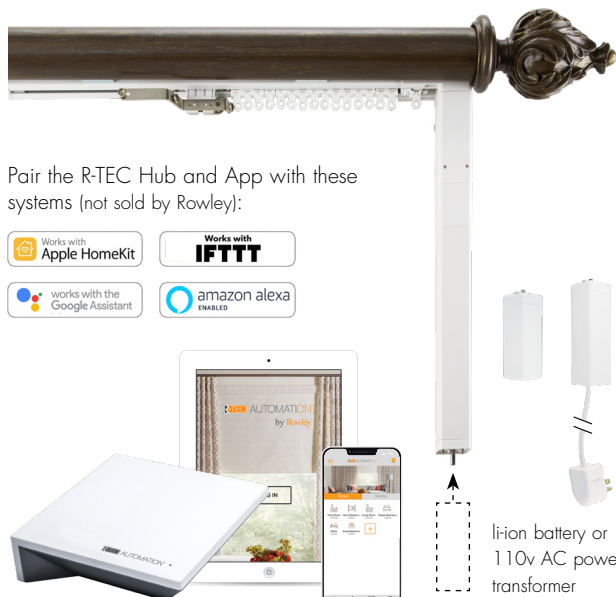

somfy.

Somfy® system features:

- max. drapery weight:
 - 99 lbs. Irismo™ 45 heavy duty motor
 - 77 lbs. Irismo™ 35 mini motor
 - 132 lbs. Glydea® ULTRA 60e RTS heavy duty motor
 - 77 lbs. Glydea® ULTRA 35e RTS standard motor
- track sold in 1 foot increments, 6' minimum
- maximum continuous length is 20'
- spliced lengths:
 - up to 33' with Irismo™ heavy duty motor
 - up to 32' with Irismo™ mini motor
 - up to 36' with Glydea® heavy duty motor
 - up to 32' with Glydea® standard motor
- 5-channel transmitter per system
- standard 10' cord; transformer is housed within the Glydea® ULTRA drapery motors
- programmable "My" Position
- curved tracks available with minimum 11.8" radius; curving fees apply
- iPhone app MyLink

Pair the MyLink App with these systems (not sold by Rowley):



motorized traverse

Somfy® motorized traverse

RIPPLEFOLD OR PINCH PLEAT

INCLUDED IN SYSTEM: SOMFY® MOTORIZED TRAVERSE TRACK WITH MOTOR AND REMOTE



Somfy motorized track

- track sold in 1 foot increments, 6' minimum
- maximum continuous length is 20'; spliced lengths up to 36'
- includes one motor, standard remote control 5-channel transmitter per track, and fascia with fascia clips when applicable
- available in white or bronze; track finish will complement fascia finish
- end drive gears available in white
- may be ordered with or without The Finial Company™ fascia options
- curved tracks available with minimum 11.8" radius; curving fees apply

Somfy Situo®/Telis standard remote control transmitter

(multi-channel handheld remote)

- 5¼"H x 1⅝"W
- 1 remote control per track
- 5 channels
- programmable My Position to set your favorite drapery position
- available in white



Somfy Irismo™ 45 motor NEW

- heavy duty motor, 1 per track
- maximum drapery weight for motor: 99 lbs
- maximum length for motor: 33'
- 26.5v Li-ion Battery Power
- motor can be mounted on right or left for center draw, or top mounted
- return hooks/snaps included; available in white
- available in white
- 5 year warranty



Somfy Irismo™ 35 Mini motor NEW

- mini motor, 1 per track
- maximum drapery weight for mini motor: 77 lbs
- maximum length for mini motor: 32'
- 24v DC Power Supply cord with plug: 158.4" cord length
- motor can be mounted on right or left for center draw, or top mounted
- return hooks/snaps included; available in white
- available in white
- 5 year warranty



Somfy Glydea® ULTRA 60e RTS motor

- heavy duty motor, 1 per track
- maximum drapery weight for heavy duty motor: 132 lbs
- maximum length for heavy duty motor: 36'
- 110v Power Supply cord with plug: 120" cord length
- motor can be mounted on right or left for center draw, or top mounted; may also be hardwired
- return hooks/snaps included; available in white
- available in brushed aluminum
- 5 year warranty (warranty voided if hardwired)



Somfy Glydea® ULTRA 35e RTS motor

- light duty motor; 1 per track
- maximum drapery weight for light duty motor: 77 lbs
- maximum length for light duty motor: 32'
- 110v Power Supply cord with plug: 120" cord length
- motor can be mounted on right or left for center draw, or top mounted; may also be hardwired
- return hooks/snaps included; available in white
- available in brushed aluminum
- 5 year warranty (warranty voided if hardwired)

carriers

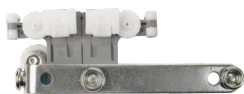

1780947 overlap
1782321 underlap

- Somfy pinch pleat or Ripplefold master carrier for center or one-way draw
- stainless steel
 - pinch pleat or Ripplefold



- 1782319
Somfy Ripplefold butt master carrier for one-way draw
- stainless steel
 - Ripplefold



- 1780953
Somfy Ripplefold butt master carrier for center draw
- stainless steel with snaps to accept Ripplefold tape
 - butt master carriers do not overlap, allowing some light to filter between draperies on center draw treatments
 - Ripplefold



- 1781415 white 1782869 bronze
Somfy standard pinch pleat glide
- ball-bearing wheel for smooth movement
 - included in system; additional glides may be ordered separately
 - available in white or bronze

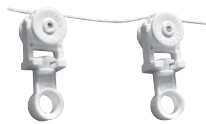

- 1780901 120% fullness; white
1780902 100% fullness; white
1780903 80% fullness; white
Somfy Ripplefold glide
- snap accepts Ripplefold tape and swivels to create fold
 - fullness 80%, 100% or 120%
 - available in white or bronze

component colors

	White	Bronze
Somfy Track	•	•
Somfy Master Carriers		
Somfy Glides	•	•
Somfy Brackets	•	•

brackets



motorized traverse

EASY TO INSTALL



HDTB35-S
steel traverse bracket, single

- adjustable 3½" - 4½" return
- 2¾"H x 1½"W backplate
- available in white or bronze



HDTB10-S
steel custom bracket, single or double

- 4½"H x 1½"W backplate

specify return up to 10"



HDTB-S
steel traverse bracket, double, can be used for single 6" return

- adjustable 5½"-6¼" front return
- adjustable 2½"-3½" back return
- 3¾"H x 1½"W backplate
- available in white or bronze



CMBC-S
Somfy single ceiling mount bracket

- ½"H x 2"Deep x 1"W
- available in white or bronze
- may only be used in systems without fascia
- single bracket; may be substituted in single or double systems

for double ceiling mount installation, install two individual brackets into ceiling



SOMFY CLIP
Somfy fascia clip

- use to attach fascia to traverse systems; included



CMTB-S
steel custom ceiling bracket, single

- 2¾"H x 1½"W backplate

specify drop: contingent upon which fascia or finials are chosen

for double ceiling mount installation, install two individual brackets into ceiling



TBKT214-S TBKT300-S

- For 2" or 2¼" poles: 3½"H x ¾"W backplate, 7⅞" front return and 3" back track return*
- For 3" poles: 3½"H x ¾"W backplate, 8¾" front return and 3" back track return*
- use to combine 2", 2¼" or 3" full wood pole with single traverse systems
- includes traverse ceiling mount bracket attached onto the bottom of the over-bracket
- fascias sold separately
- available in any of our 50 standard hand painted finishes on page 34 or your own custom finish

**for custom bracket returns, see page 56 of the 2018 Drapery Hardware Catalog*

accessories

these additional accessories are available for purchase separately



16 channel RTS remote control transmitter with programmable timer and on-screen display

- 6"H x 2"W
- range: 65'
- available with wall mount clip
- available in silver

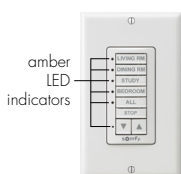

Somfy wireless RTS wall switches

- 4½"H x 2¾"W
- range: 65'
- open or close the motorized drapery when you enter or exit a room
- battery-powered, wireless switch
- customizable buttons for selecting window treatments throughout the house
- custom button labels available
- available in white



Somfy indoor sun control

- 2¾" Dia x ¾"D
- range: 65'
- uses the intensity of the sun to provide automatic control of window coverings in the home
- mounts on window sill or window glass
- available in white



Somfy myLink™
Control your window coverings with a smartphone or tablet

The myLink™ puts you in control, so you can operate your motorized applications whether you're home or away. On vacation and realized you forgot to close your draperies? Not a problem, with a simple tap of a button in the mylink app, you can close all your window treatments at once.



Free app for iOS and Android



See retail price list to learn more about additional Somfy accessories.

fascia profiles

slim round smooth, no finials

- 1 7/8" diameter, available with flush ends or mitered returns

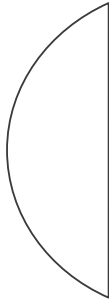

flat smooth, no finials

- 2 1/4" diameter available
- see pages 69-76 of the 2018 Drapery Hardware Catalog for coordinating finial options



smooth

- 1 3/8", 2", 2 1/4" and 3" diameters available
- see pages 62-64, 69-76 and 82-84 of the 2018 Drapery Hardware Catalog for coordinating finial options

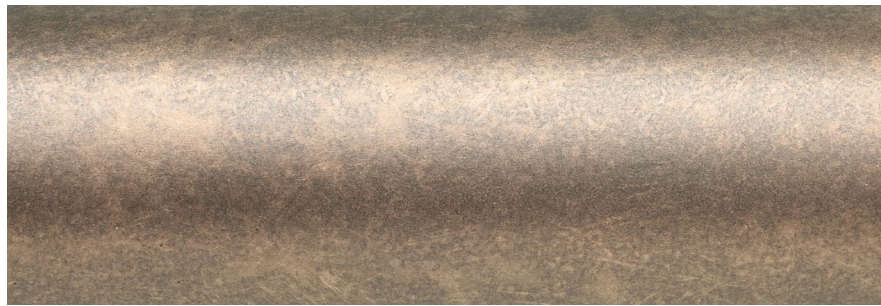
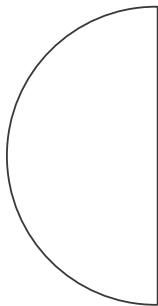

grooved

- 1 3/8", 2", 2 1/4" and 3" diameters available
- see pages 62-64, 69-76 and 82-84 of the 2018 Drapery Hardware Catalog for coordinating finial options

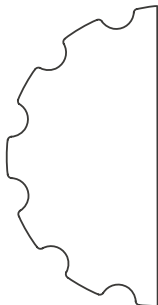

fluted

- 1³/₈", 2" and 2¹/₄" diameters available
- see pages 62-64, 69-76 and 82-84 of the 2018 Drapery Hardware Catalog for coordinating finial options



reeded

- 1³/₈", 2", 2¹/₄" and 3" diameters available
- see pages 62-64, 69-76 and 82-84 of the 2018 Drapery Hardware Catalog for coordinating finial options

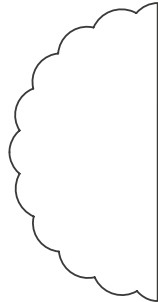

wide reeded

- 2¹/₄" diameter available
- see pages 69-76 of the 2018 Drapery Hardware Catalog for coordinating finial options

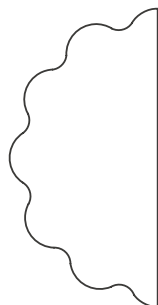

mitered returns (sold separately)

- 1³/₈", 1⁷/₈", 2", 2¹/₄" and 3" diameters available
- all profiles



motorized traverse

how to order the perfect motorized traverse system every time - in 4 easy steps

1 SELECT YOUR TRAVERSE SYSTEM

SINGLE SYSTEM



single traverse with or without fascia
motorized

DOUBLE SYSTEM



double traverse with or without fascia (front fascia shown; front and back fascia also available)
motorized

2 SELECT A FASCIA DIAMETER, FASCIA PROFILE, FINIALS & FINISH

	1 ³ / ₈ " Dia	1 ⁷ / ₈ " Dia	2" Dia	2 ¹ / ₄ " Dia	3" Dia
Slim Round Smooth		<input type="checkbox"/>			
Flat Smooth				<input type="checkbox"/>	
Smooth	<input type="checkbox"/>		<input type="checkbox"/>	<input type="checkbox"/>	<input type="checkbox"/>
Grooved	<input type="checkbox"/>		<input type="checkbox"/>	<input type="checkbox"/>	<input type="checkbox"/>
Fluted	<input type="checkbox"/>		<input type="checkbox"/>	<input type="checkbox"/>	
Reeded	<input type="checkbox"/>		<input type="checkbox"/>	<input type="checkbox"/>	<input type="checkbox"/>
Wide Reeded				<input type="checkbox"/>	

fascia choice: no fascia
or

flush end

mitered returns _____

(specify return, see mitered return charges.)

• flat smooth and slim round smooth available

• 1³/₈", 1⁷/₈", 2", 2¹/₄" and 3" diameters available
• all profiles

add finials and select finish: _____

choose finish from list of available finishes to the right or submit a custom finish request.

• finials not available for flat smooth and slim round smooth fascias

3 SELECT YOUR DRAPERY STYLE



PINCH PLEAT

overlap



RIPPLEFOLD

overlap butt master

60% 80% 100% 120% fullness

60% fullness not available on Somfy motorized systems

4 COMPLETE YOUR TRAVERSE SPECIFICATIONS

- Mount Type: wall mount ceiling mount
 • may only be used in systems without fascia

COMPONENT COLORS

	motorized	
	R-TEC Automation®	Somfy®
WHITE	<input type="checkbox"/>	<input type="checkbox"/>
BRONZE	<input type="checkbox"/>	<input type="checkbox"/>

Direction:

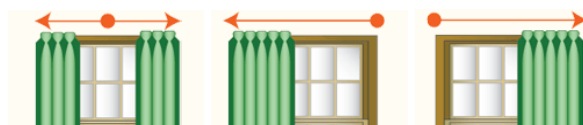

- center draw one-way left one-way right

Motor & Power Options:

- R-TEC Automation® Slim
 Li-ion Battery (includes battery charger & USB cable) 110v AC Power Transformer (includes 10' cord with 3 conductor male plug)

Additional Power Options Sold Separately:

- Solar Panel Charger (includes L-bracket, cables & fastener) 110v AC Power Transformer (includes 30' cord, requires plug below)
 3 Conductor Male Plug

- Somfy Glydea® ULTRA 60e HD* Somfy Irismo™ 45*
 Somfy Glydea® ULTRA 35e Std* Somfy Irismo™ 35 Mini*

*power options included

Based on your specified finish we supply track and brackets that best match the finish on your fascia. Please refer to the Finish Reference Guide to the right. If you order a custom match finish, please specify your track color.

Components are included in the per foot track price, as listed in the Retail Price List. Components will match the track color when applicable.

Standard glides are 4 per foot. Standard brackets are 2 end brackets with 1 support bracket for every 3-4 feet of track.

Wood pole profiles available in 1 7/8", 2", 2 1/4" and 3" diameters can be used as fascia.

Spliced fascia will be cut at a 45° angle for an obscure splice upon request.

Spliced fascia can be blended for an additional fee (see Retail Price List). Blended fascia will be properly connected and shipped in one continuous length.

Finish name	Finish code	Recommended track & bracket color
STANDARD FINISHES		
Charred Toasted Oak	800	Bronze
Bronzed Ore	810	Bronze
Sea Salt Black	820	Bronze
Driftwood	830	White
White with Gold Accents	840	White
Soft Brass	850	Bronze
Grayed Brass	860	Bronze
Chalet Gray	870	White
Parchment	880	White
Warm Walnut	890	Bronze
Gilded Red	600	Bronze
Cobalt Bronze	610	Bronze
Weathered Iron	620	Bronze
Ash Gray	630	White
Oil Rubbed Bronze	640	Bronze
Hickory	650	Bronze
Antique White	660	White
Espresso	670	Bronze
Aged Gold	680	Bronze
Champagne	690	Bronze
Graphite	700	Bronze
Tarnished Silver	710	Bronze
Tawny Oak	720	Bronze
Rose Gold	730	Bronze
Smoky Mocha	740	Bronze
Polished Gold	750	Bronze
Rustic Iron	760	Bronze
Bronze Patina	770	Bronze
Hazelwood	780	Bronze
Vintage Bronze	790	Bronze
Bronze	105	Bronze
Bronze with Gold	106	Bronze
Bronze with Gold and Gray	107	Bronze
Flat Black	109	Bronze
Flat Black with Gold	110	Bronze
Silver with Gold	112	White
Walnut Gold	117	Bronze
Dark Walnut Gloss with Gold	126	Bronze
Antique Steel	129	Bronze
Antique Steel with Black Highlights	129B	Bronze
Gray with Gold	150	White
Antique	155	Bronze
Walnut Gold with Gray Accents	200	Bronze
Walnut	240	Bronze
Platinum	250	Bronze
Platinum with Black Highlights	250B	Bronze
Mahogany Rust	270	Bronze
Pewter	320	Bronze
Bronze with Black	330	Bronze
Statuary Bronze with Gold	350G	Bronze

1¹/₈" - 1³/₈" manual modern metal traverse systems



manual modern metal traverse baton draw

The perfect modern solution for residential or commercial applications.

Available in 1¹/₈" and 1³/₈" diameters.

Center or one-way draw, with pinch pleat or Ripplefold glides in 60%, 80%, 100% and 120% fullness.

Coordinates with Modern Metal Collection finials.

Available in 5 contemporary finishes.

Choose from any of our 50 standard hand painted finishes located on page 34 or your own custom finish.

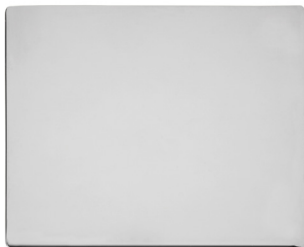

CH Chrome



BN Brushed Nickel



SG Satin Gold



BBN Brushed Black Nickel

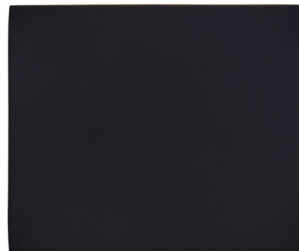

MK Matte Black

- maximum continuous track length in Chrome and Satin Gold is 8', all other finishes available up to 12'. Center draw tracks can be spliced for longer lengths, see order form on pages 32 - 33 for details

standard finishes

- our 1¹/₈" - 1³/₈" modern metal traverse collection is also available in any of our 50 beautifully hand painted finishes located on the back cover of the 2018 Drapery Hardware Catalog or any custom finish
- please see retail price list for finish options and surcharges

modern metal traverse

manual
traverse

BATON DRAW, RIPPLEFOLD OR PINCH PLEAT
AVAILABLE IN 1 1/8" OR 1 3/8" DIAMETERS

single traverse system, wall mount

- wall bracket: 3 1/2" or 6" return options
- traverse system includes track, brackets, master carriers, glides and round end caps
- batons, modern collection finials and cuffs/collars sold separately

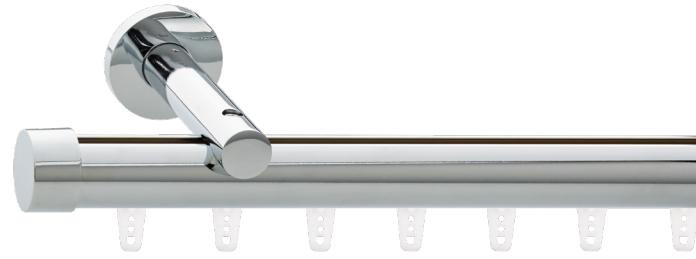

double traverse system, wall mount

- wall bracket: 3" and 7 1/2" returns
- traverse system includes tracks, brackets, master carriers, glides and round end caps
- batons, modern collection finials and cuffs/collars sold separately

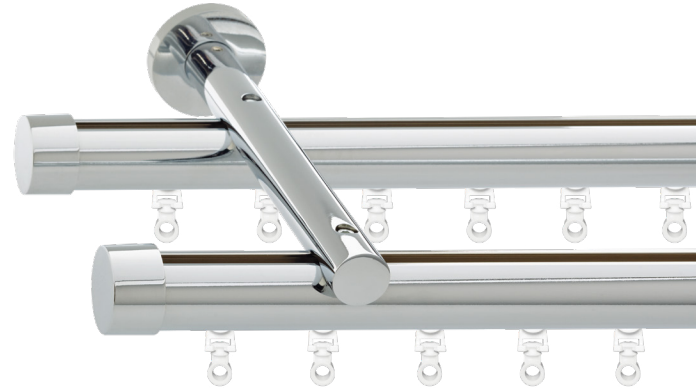

single traverse system, ceiling mount

- ceiling bracket: 2 3/8" drop
- traverse system includes track, brackets, master carriers, glides and round end caps
- batons, modern collection finials and cuffs/collars sold separately



double traverse system, ceiling mount

- ceiling bracket: 2 5/8" drop, 4 1/2" apart
- traverse system includes tracks, brackets, master carriers, glides and round end caps
- batons, modern collection finials and cuffs/collars sold separately



single traverse system, low-profile ceiling mount

- ceiling bracket: 5/32" drop
- traverse system includes track, brackets, master carriers, glides and round end caps
- batons, modern collection finials and cuffs/collars sold separately



brackets

EASY TO INSTALL - ATTACH TO TRACK WITH A SET SCREW



TFCMT118400
1 1/8" metal wall bracket, single
3 1/2" return, 1 7/8" Dia backplate



TFCMT118402
1 1/8" metal wall bracket, double
7 1/2" front and 3" back return, 1 7/8" Dia backplate



TFCMT118404
1 1/8" metal ceiling bracket, double
2 5/8" drop, 4 1/2" apart, 1 7/8" Dia ceiling plate

TFCMT138400
1 3/8" metal wall bracket, single
3 1/2" return, 2 7/16" Dia backplate

TFCMT138402
1 3/8" metal wall bracket, double
7 1/2" front and 3" back return, 2 7/16" Dia backplate

TFCMT138404
1 3/8" metal ceiling bracket, double
2 5/8" drop, 4 1/2" apart, 1 7/8" Dia ceiling plate

TFCMT118401
1 1/8" metal wall bracket, single
6" return, 1 7/8" Dia backplate

TFCMT138401
1 3/8" metal wall bracket, single
6" return, 2 7/16" Dia backplate



TFCMT118403
1 1/8" metal ceiling mount bracket
2 3/8" drop, 1 7/8" Dia ceiling plate



TFCMT118405
1 1/8" metal ceiling bracket extender
2" drop



TFCMT118406
1 1/8" low profile metal ceiling bracket
5/32" drop

TFCMT138403
1 3/8" metal ceiling mount bracket
2 3/8" drop, 1 7/8" Dia ceiling plate

TFCMT138405
1 3/8" metal ceiling bracket extender
2" drop

TFCMT138406
1 3/8" low profile metal ceiling bracket
5/32" drop

accessories

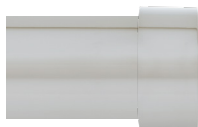

TFCM118191
1 1/8" round end cap



TFCMT118409
1 1/8" hinged elbow
2 7/8" L



TFCMT118407
connector/splice
Brass



TFCMT138407
connector/splice
Steel

TFCM138191
1 3/8" round end cap

TFCMT138409
1 3/8" hinged elbow
2 7/8" L

carriers

COMPONENTS ARE WHITE; TO ORDER COMPONENTS IN BRONZE, ADD /BR

Modern Metal Traverse Systems work with pinch pleat ball-bearing glides or Ripplefold roller glides. For more details on pinch pleat and Ripplefold glides, please see retail price list.

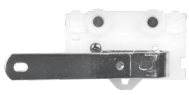

- BT3005R BT3005L**
pinch pleat master carriers
- stainless steel overlap arms
 - multi-wheel design for smooth movement
 - baton draw
 - right (R) or left (L)
 - available in white or bronze /BR

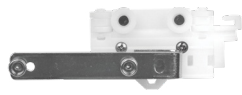

- BT3125R BT3125L**
Ripplefold overlap master carriers
- stainless steel overlap arms with snaps to accept Ripplefold tape
 - multi-wheel design for smooth movement
 - overlap master carriers come standard unless otherwise specified
 - baton draw
 - right (R) or left (L)
 - available in white or bronze /BR



- BT3600R BT3600L**
Ripplefold butt master carriers
- snaps to accept Ripplefold tape
 - multi-wheel design for smooth movement
 - butt master carriers do not overlap, allowing some light to filter between draperies on center draw treatments
 - butt master carriers must be specified for substitution
 - baton draw
 - right (R) or left (L)
 - available in white or bronze /BR



- CP10 CP10/BR**
ball-bearing pinch pleat glide
- ball-bearing wheel for smooth movement
 - available in white or bronze

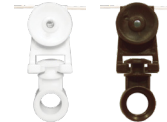

- | | | |
|--------------|-----------------|---------------|
| R4060 | R4060/BR | 60% fullness |
| R4080 | R4080/BR | 80% fullness |
| R4100 | R4100/BR | 100% fullness |
| R4120 | R4120/BR | 120% fullness |
- Ripplefold glide
- Ripplefold glides with detachable pendants
 - available in white or bronze



- BT4333**
glide stop
- stainless steel

component colors

	White	Bronze
Master Carrier	•	•
Glides	•	•

batons



- A TFCM312S**
metal baton
3/8" Dia, available in 36"
- TFCM314S**
metal baton
3/8" Dia, available in 48"
- TFCM316S**
metal baton
3/8" Dia, available in 60"
- B ABTN-36**
clear acrylic baton
5/8" Dia, available in 36"
- ABTN-48**
clear acrylic baton
5/8" Dia, available in 48"
- C TFC314HS-48**
handicap metal baton
BN or MK only
3/8" Dia, available in 48"
- TFC314HS-60**
handicap metal baton
BN or MK only
3/8" Dia, available in 60"

finials

See pages 4-6 of the 2018 Drapery Hardware Catalog and website for more information on coordinating finial options. Cuffs or Collars must be ordered separately for finials to be compatible with tracks.

end caps

Round End Caps included; order our Bex End Cap pictured for an alternative look. Available in 1 1/8" and 1 3/8" diameters.

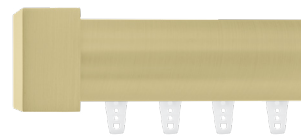

finials

Modern Metal Collection finials are designed to coordinate with both track diameters.



cuffs & collars

Modern Collection finials are designed to coordinate with both 1 1/8" and 1 3/8" cuffs and collars. Please select a cuff or collar in any modern finish to match your selected traverse system diameter.



1³/₈" manual metal traverse systems

manual metal traverse baton draw

The perfect decorative solution for residential or commercial applications.

Available in 1³/₈" diameter.

Center or one-way draw, with pinch pleat or Ripplefold glides in 60%, 80%, 100% and 120% fullness.

Coordinates with Metal Collection finials.

Available in 7 beautifully layered plated finishes.

Choose from any of our 50 standard hand painted finishes located on page 34 or your own custom finish.



PN Polished Nickel



AP Antique Pewter



AB Antique Brass



BZ Brushed Bronze



ORB Oil Rubbed Bronze



SK Satin Black



MK Matte Black

Matte Black
coordinates with
VZ & DRB finials



VZ

DRB

- maximum continuous track length in BZ and ORB is 8', all other finishes available up to 12'
- center draw tracks can be spliced for longer lengths, see order form on pages 32 - 33 for details
- Matte Black (MK) tracks, brackets and batons coordinate with Venetian Bronze (VZ) and Dark Oil Rubbed Bronze (DRB) finials

standard finishes

- our 1³/₈" metal traverse collection is also available in any of our 50 beautifully hand painted finishes located on the back cover of the 2018 Drapery Hardware Catalog or any custom finish
- please see retail price list for finish options and surcharges

metal traverse

BATON DRAW, RIPPLEFOLD OR PINCH PLEAT
AVAILABLE IN 1³/₈" DIAMETER

single traverse system, wall mount

- wall bracket: 3¹/₂" or 6" return options
- traverse system includes track, brackets, master carriers, glides and round end caps
- batons and metal collection finials sold separately

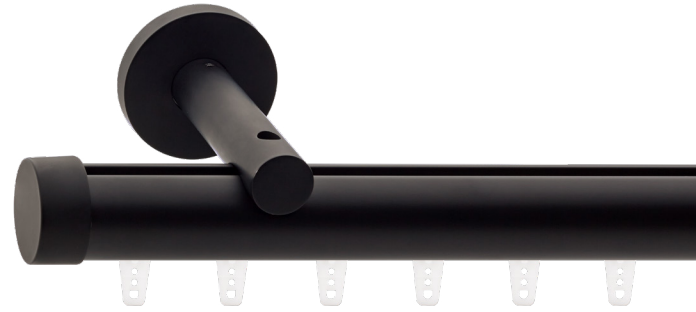

double traverse system, wall mount

- wall bracket: 3" and 7¹/₂" returns
- traverse system includes tracks, brackets, master carriers, glides and round end caps
- batons and metal collection finials sold separately



single traverse system, ceiling mount

- ceiling bracket: 2³/₈" drop
- traverse system includes track, brackets, master carriers, glides and round end caps
- batons and metal collection finials sold separately



double traverse system, ceiling mount

- ceiling bracket: 2⁵/₈" drop, 4¹/₂" apart
- traverse system includes tracks, brackets, master carriers, glides and round end caps
- batons and metal collection finials sold separately



single traverse system, low-profile ceiling mount

- ceiling bracket: 5³/₃₂" drop
- traverse system includes track, brackets, master carriers, glides and round end caps
- batons and metal collection finials sold separately



brackets

EASY TO INSTALL - ATTACH TO TRACK WITH A SET SCREW



TFCMT138400
1 3/8" metal wall bracket, single
3 1/2" return, 2 7/16" Dia backplate



TFCMT138402
1 3/8" metal wall bracket, double
7 1/2" front and 3" back return, 2 7/16" Dia backplate



TFCMT138404
1 3/8" metal ceiling bracket, double
2 3/8" drop, 4 1/2" apart, 1 7/8" Dia ceiling plate

TFCMT138401
1 3/8" metal wall bracket, single
6" return, 2 7/16" Dia backplate



TFCMT138403
1 3/8" metal ceiling mount bracket
2 3/8" drop, 1 7/8" Dia ceiling plate



TFCMT138405
1 3/8" metal ceiling bracket extender
2" drop



TFCMT138406
1 3/8" low profile metal ceiling bracket
3/2" drop

accessories

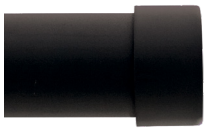

TFCM138191
1 3/8" round end cap



TFCMT138409
1 3/8" hinged elbow
2 7/8" L



TFCMT138407
connector/splice

carriers

COMPONENTS ARE WHITE; TO ORDER COMPONENTS IN BRONZE, ADD /BR

Metal Traverse Systems work with ball-bearing pinch pleat or Ripplefold roller glides. For more details on pinch pleat and Ripplefold glides, please see retail price list.



- BT3005R BT3005L**
pinch pleat master carriers
- stainless steel overlap arms
 - multi-wheel design for smooth movement
 - baton draw
 - right (R) or left (L)
 - available in white or bronze /BR

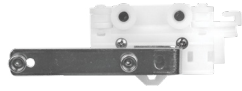

- BT3125R BT3125L**
Ripplefold overlap master carriers
- stainless steel overlap arms with snaps to accept Ripplefold tape
 - multi-wheel design for smooth movement
 - overlap master carriers come standard unless otherwise specified
 - baton draw
 - right (R) or left (L)
 - available in white or bronze /BR



- BT3600R BT3600L**
Ripplefold butt master carriers
- snaps to accept Ripplefold tape
 - multi-wheel design for smooth movement
 - butt master carriers do not overlap, allowing some light to filter between draperies on center draw treatments
 - butt master carriers must be specified for substitution
 - baton draw
 - right (R) or left (L)
 - available in white or bronze /BR



- CP10 CP10/BR**
ball-bearing pinch pleat glide
- ball-bearing wheel for smooth movement
 - available in white or bronze

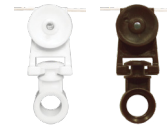

- | | | |
|--------------|-----------------|---------------|
| R4060 | R4060/BR | 60% fullness |
| R4080 | R4080/BR | 80% fullness |
| R4100 | R4100/BR | 100% fullness |
| R4120 | R4120/BR | 120% fullness |
- Ripplefold glide
- Ripplefold glides with detachable pendants
 - available in white or bronze



- BT4333**
glide stop
- stainless steel

component colors

	White	Bronze
Master Carrier	•	•
Glides	•	•

batons



PN AP AB BZ ORB SK MK
A



B

- A TFCM3125**
metal baton
3/8" Dia, available in 36"
- TFCM3145**
metal baton
3/8" Dia, available in 48"
- TFCM3165**
metal baton
3/8" Dia, available in 60"
- B ABTN-36**
clear acrylic baton
3/8" Dia, available in 36"
- ABTN-48**
clear acrylic baton
3/8" Dia, available in 48"
- C TFC314HS-48**
handicap metal baton
BN, AB, BZ or MK only
3/8" Dia, available in 48"
- TFC314HS-60**
handicap metal baton
BN, AB, BZ or MK only
3/8" Dia, available in 60"



C

*BN coordinates with PN

finials

See page 11 of the 2018 Drapery Hardware Catalog and website for more information on coordinating finial options from the 1 3/8" metal collection.

end caps

Round End Caps included; order our Wells End Cap pictured for a more stylized look.



finials

Select from 8 finial designs.

1 SELECT YOUR TRAVERSE SYSTEM

WALL MOUNT



- single traverse wall mount
- return choice:
 - 3 1/2"
 - 6"



- double traverse wall mount

CEILING MOUNT



- single traverse ceiling mount



- single traverse ceiling clip



- double traverse ceiling mount

2 SELECT A TRACK DIAMETER, WIDTH AND FINISH

MODERN METAL TRAVERSE

	1 1/8" Dia	1 3/8" Dia	Track Cut Length (in.)	Max. Length
CH Chrome	<input type="checkbox"/>	<input type="checkbox"/>		192" Center 96" One-Way
BN Brushed Nickel	<input type="checkbox"/>	<input type="checkbox"/>		288" Center 144" One-Way
SG Satin Gold	<input type="checkbox"/>	<input type="checkbox"/>		192" Center 96" One-Way
BBN Brushed Black Nickel	<input type="checkbox"/>	<input type="checkbox"/>		288" Center 144" One-Way
MK Matte Black	<input type="checkbox"/>	<input type="checkbox"/>		288" Center 144" One-Way

METAL TRAVERSE

	1 3/8" Dia	Track Cut Length (in.)	Max. Length
PN Polished Nickel	<input type="checkbox"/>		288" Center 144" One-Way
AP Antique Pewter	<input type="checkbox"/>		288" Center 144" One-Way
AB Antique Brass	<input type="checkbox"/>		288" Center 144" One-Way
BZ Brushed Bronze	<input type="checkbox"/>		192" Center 96" One-Way
ORB Oil Rubbed Bronze	<input type="checkbox"/>		192" Center 96" One-Way
MK Matte Black*	<input type="checkbox"/>		288" Center 144" One-Way
SK Satin Black	<input type="checkbox"/>		288" Center 144" One-Way

*Coordinates with Venetian Bronze (VZ) and Dark Oil Rubbed Bronze (DRB) finials.

3 SELECT YOUR DRAPERY STYLE



PINCH PLEAT

- overlap



RIPPLEFOLD

- overlap
- butt master
- 60% 80% 100% 120% fullness

4 COMPLETE YOUR TRAVERSE SPECIFICATIONS

Direction:

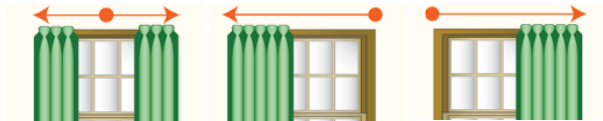

center draw one-way left one-way right

Component Colors:

White Bronze

	White	Bronze
Master Carrier Body	•	•
Glides	•	•

5 ADD ON BATONS AND FINIALS, CUFFS OR COLLARS

Batons:

add baton with steel clip
(baton sold separately)

metal finish: _____ acrylic handicap metal finish: _____

36" 36" 48"

48" 48" 60"

60"

Finials:

MODERN METAL TRAVERSE

	finial	finial finish	metal modern cuff	metal modern collar	metal transitional collar	cuff/collar finish
TFCM600 Bryant	<input type="checkbox"/>		<input type="checkbox"/>	<input type="checkbox"/>	<input type="checkbox"/>	
TFCM600/CL Bryant Acrylic	<input type="checkbox"/>	-	<input type="checkbox"/>	<input type="checkbox"/>	<input type="checkbox"/>	
TFCM601 Declan	<input type="checkbox"/>		<input type="checkbox"/>	<input type="checkbox"/>	<input type="checkbox"/>	
TFCM601/CL Declan Acrylic	<input type="checkbox"/>	-	<input type="checkbox"/>	<input type="checkbox"/>	<input type="checkbox"/>	
TFCM602 Upton	<input type="checkbox"/>		<input type="checkbox"/>	<input type="checkbox"/>	<input type="checkbox"/>	
TFCM602/CL Upton Acrylic	<input type="checkbox"/>	-	<input type="checkbox"/>	<input type="checkbox"/>	<input type="checkbox"/>	
TFCM603 Delano	<input type="checkbox"/>		<input type="checkbox"/>	<input type="checkbox"/>	<input type="checkbox"/>	
TFCM604 Mercer	<input type="checkbox"/>		<input type="checkbox"/>	<input type="checkbox"/>	<input type="checkbox"/>	
TFCM605 Luca	<input type="checkbox"/>		<input type="checkbox"/>	<input type="checkbox"/>	<input type="checkbox"/>	
TFCM606 Stiles	<input type="checkbox"/>		<input type="checkbox"/>	<input type="checkbox"/>	<input type="checkbox"/>	
TFCM691 Anson	<input type="checkbox"/>		<input type="checkbox"/>	<input type="checkbox"/>	<input type="checkbox"/>	
TFCM691/CL Anson Acrylic	<input type="checkbox"/>	-	<input type="checkbox"/>	<input type="checkbox"/>	<input type="checkbox"/>	
TFCM692 Eason	<input type="checkbox"/>		<input type="checkbox"/>	<input type="checkbox"/>	<input type="checkbox"/>	
TFCM692/CL Eason Acrylic	<input type="checkbox"/>	-	<input type="checkbox"/>	<input type="checkbox"/>	<input type="checkbox"/>	
TFCM118690 Bex 1 1/8" End Cap	<input type="checkbox"/>		-	-	-	-
TFCM138690 Bex 1 3/8" End Cap	<input type="checkbox"/>		-	-	-	-

METAL TRAVERSE

	finial	finial finish
TFCM138100 Turner	<input type="checkbox"/>	
TFCM138101 Britton	<input type="checkbox"/>	
TFCM138102 Ashby	<input type="checkbox"/>	
TFCM138103 Abington	<input type="checkbox"/>	
TFCM138104 Harlow	<input type="checkbox"/>	
TFCM138105 Weston	<input type="checkbox"/>	
TFCM138106 Brentford	<input type="checkbox"/>	
TFCM138107 Rothwell	<input type="checkbox"/>	
TFCM138190 Wells End Cap	<input type="checkbox"/>	

manual heavy duty traverse systems



manual heavy duty traverse corded or baton draw

Recommended for heavier fabrics with lining or treatments mounted over 10' from the floor.

Featuring two new heavy duty track profiles.

Glides and end pulleys now available in coordinating bronze finish.

Available with 1³/₈" , 1⁷/₈" , 2" , 2¹/₄" and 3" diameter fascia profiles or without wood fascia.

New c-ring system option available in 1³/₈" , 2" , 2¹/₄" and 3" diameter fascia profiles.

Choose from any of our 50 standard hand painted finishes below or your own custom finish.



heavy duty traverse

CORDED OR BATON DRAW, RIPPLEFOLD OR PINCH PLEAT

single traverse system

- standard corded single bracket has 3 1/4" return; standard baton single brackets are adjustable: 2 1/2" - 3 1/2" return
- longer return bracket options may be substituted at no charge
- c-rings available for 1 3/8", 2", 2 1/4" and 3"

double traverse system

- standard corded double brackets are adjustable: 2 1/2" - 4 1/2" back track and 5 1/2" - 7" front track return; standard baton double brackets are adjustable: 2" - 3" back track and 4" - 5 1/2" front track return
- longer return bracket options may be substituted at no charge
- c-rings available for 1 3/8", 2", 2 1/4" and 3" (front track)

single or double traverse system with mitered returns

- standard corded single bracket has 3 1/4" return; standard baton single brackets are adjustable: 2 1/2" - 3 1/2"
- standard corded double brackets are adjustable: 2 1/2" - 4 1/2" back track and 5 1/2" - 7" front track return; standard baton double brackets are adjustable: 2" - 3" back track and 4" - 5 1/2" front track return
- c-rings not available

stationary front pole with back traverse system

- stationary front pole and TBKT bracket are included
- full rings available on stationary; c-rings not available

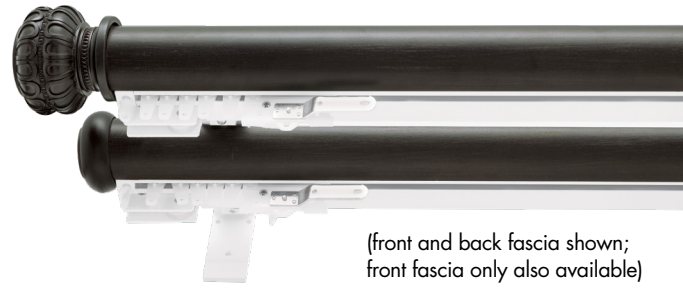
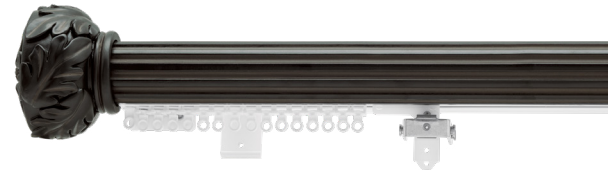

(front and back fascia shown; front fascia only also available)

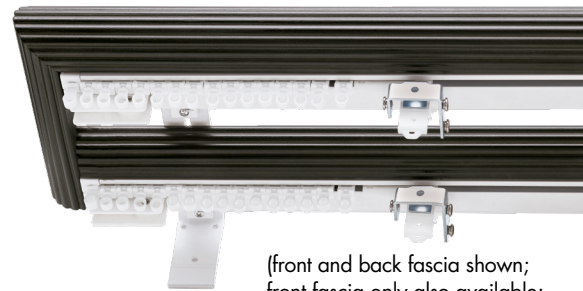

(front and back fascia shown; front fascia only also available; mitered returns on front only)

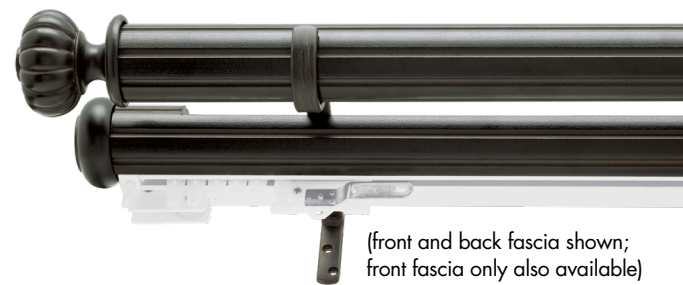

(front and back fascia shown; front fascia only also available)

coordinating fascia profiles & finials

For more details on fascia options, see pages 20-21. Finials sold separately. Please reference the 2018 Drapery Hardware Catalog for coordinating finials: 1 3/8" Dia on pages 62-64, 2" - 2 1/4" Dia on pages 69-76 and 3" Dia on pages 82-84.



slim round smooth, no finials
• 1 7/8" Dia



flat smooth, no finials
• 2 1/4" Dia

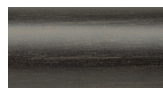

smooth
• 1 3/8", 2", 2 1/4" and 3" Dia



grooved
• 1 3/8", 2", 2 1/4" and 3" Dia



fluted
• 1 3/8", 2" and 2 1/4" Dia



reeded
• 1 3/8", 2", 2 1/4" and 3" Dia



wide reeded
• 2 1/4" Dia



mitered returns (sold separately)
• 1 3/8", 1 7/8", 2", 2 1/4" and 3" Dia
• all profiles

manual traverse

carriers

COMPONENTS ARE WHITE; TO ORDER COMPONENTS IN BRONZE, ADD /BR



pinch pleat



ripplefold



CP10 CP10/BR
ball-bearing pinch pleat glide

- ball-bearing wheel for smooth movement
- available in white or bronze

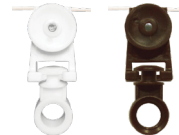

R4060 R4080 R4100 R4120 | **R4060/BR R4080/BR R4100/BR R4120/BR**
60% fullness
80% fullness
100% fullness
120% fullness

Ripplefold glide

- Ripplefold glides with detachable pendants
- available in white or bronze



BT4333
glide stop

- stainless steel

brackets and pinch pleat glides

quantity per system

	6'	7'	8'	9'	10'	11'	12'	13'	14'	15'	16'
pinch pleat glides	24	28	32	36	40	44	48	52	56	60	64
brackets	3	3	4	4	4	5	5	5	6	6	6

standard glides are 4 per foot, standard brackets are 1 every 3-4 feet

component colors

	White	Bronze
Track	•	•
Master Carriers	•	•
Glides	•	•
End Pulleys	•	•
Brackets	•	•



c-ring

138CR
2"ID, 3¼"OD

200CR
2½"ID, 3¾"OD

214CR
3½"ID, 4¾"OD

300CR
3½"ID, 5"OD



BT3005R BT3005L
baton pinch pleat master carriers

- stainless steel overlap arms
- multi-wheel design for smooth movement
- right (R) or left (L)
- available in white or bronze /BR



CD3300R CD3300L
corded pinch pleat master carriers

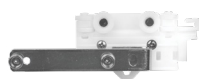

BT3125R BT3125L
baton Ripplefold master carriers

- stainless steel overlap arms with snaps to accept Ripplefold tape
- multi-wheel design for smooth movement
- overlap master carriers come standard unless otherwise specified
- right (R) or left (L)
- available in white or bronze /BR



CD3412R CD3412L
corded Ripplefold master carriers



BT3600R BT3600L
baton Ripplefold butt master carriers

- stainless steel arms with snaps to accept Ripplefold tape
- multi-wheel design for smooth movement
- butt master carriers do not overlap, allowing some light to filter between draperies on center draw treatments
- butt master carriers must be specified for substitution
- right (R) or left (L)
- available in white or bronze /BR



CD3600R CD3600L
corded Ripplefold butt master carriers



BT4013
baton pinch pleat end pulley

- available in white or bronze /BR



BT4123
baton Ripplefold end pulley

- available in white or bronze /BR



CD4311R CD4311L
corded universal end pulley body

- pendants sold separately: CP30 pinch pleat, CPC30 pinch pleat with c-rings or R1002 Ripplefold
- right (R) or left (L)
- available in white or bronze /BR



CD4310R CD4310L
corded one-way end pulley body

- right (R) or left (L)
- available in white or bronze /BR

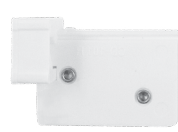

brackets

EASY TO INSTALL; NEW & IMPROVED BRACKETS
COMPONENTS ARE WHITE; TO ORDER COMPONENTS IN BRONZE, ADD /BR

corded



- TB035-H**
wall traverse bracket, single
- 3¼" return
 - 2⅝"H x 1"W backplate
 - available in white or bronze /BR



- TB060-H**
wall traverse bracket, double
- adjustable 5½"-7" front return
 - adjustable 2½"-4½" back return
 - 3⅜"H x 1⅞"W backplate
 - available in white or bronze /BR



- TB100-H**
wall traverse bracket, single, double or triple
- adjustable up to 10"
 - 4½"H x 1½"W backplate
 - available in white or bronze /BR



- CD533**
single ceiling mount bracket
- ⅝"H x 2⅝"Deep x 7⁄8"W
 - may only be used in systems without fascia
 - single bracket; may be substituted in single or double systems
 - available in white

for double ceiling mount installation, install two brackets into ceiling



- CD4001FC**
fascia mount clip
- use to attach fascia to traverse systems; included
 - available in zinc

baton



- TB035-HB**
wall traverse bracket, single
- adjustable 2½"-3½" return
 - 1⅝"H x 1⅜"W backplate
 - available in white or bronze /BR



- TB060-HB**
wall traverse bracket, heavy duty, single or double
- adjustable 5"-6¼" front return
 - adjustable 2¼"-3½" back return
 - 3⅜"H x 1¼"W backplate
 - available in white or bronze /BR



- TB100-HB**
wall traverse bracket, single, double or triple
- adjustable up to 10"
 - 4½"H x 1½"W backplate
 - available in white or bronze /BR



- BT5333**
single ceiling mount bracket
- ¼"H x 2 ¼"Deep x 1"W
 - may only be used in systems without fascia
 - single bracket
 - available in white



- BT4003NFC**
fascia mount clip
- use to attach fascia to traverse systems; included
 - available in zinc

batons are sold separately (see page 80 of 2018 Drapery Hardware Catalog)

corded or baton



- CP500**
drapery return bracket
- 1¾" return
 - ⅝"H x ½"W backplate
 - allows for return on track hardware in traverse systems; included
 - available in zinc



- TBKT214-H TBKT300-H**
(brackets are for cord draw; add B to item number to order baton draw)
- For 2" or 2¼" poles: 3½"H x ¾"W backplate, 7⅞" front return and 3" back track return*
 - For 3" poles: 3½"H x ¾"W backplate, 8¾" front return and 3" back track return*
 - use to combine 2", 2¼" or 3" full wood pole with single traverse systems
 - includes traverse ceiling mount bracket attached onto the bottom of the over-bracket
 - fascias sold separately
 - available in any of our 50 standard hand painted finishes on page 34 or your own custom finish



- CMTB-H CMTB-HB**
steel custom ceiling bracket, single
- 2¾"H x 1½"W backplate
- specify drop: contingent upon which fascia or finials are chosen*
- for double ceiling mount installation, install two individual brackets into ceiling*

*for custom bracket returns, see page 56 of the 2018 Drapery Hardware Catalog

1 SELECT YOUR TRAVERSE SYSTEM

SINGLE SYSTEM



single traverse with or without fascia
heavy duty



single traverse with fascia & c-rings
heavy duty

DOUBLE SYSTEM



double traverse with or without fascia
heavy duty



stationary front pole and traverse back
heavy duty



double traverse with fascia & c-rings on front fascia
heavy duty

2 SELECT A FASCIA DIAMETER, FASCIA PROFILE, FINIALS & FINISH

	1 ³ / ₈ " Dia	1 ⁷ / ₈ " Dia	2" Dia	2 ¹ / ₄ " Dia	3" Dia
Slim Round Smooth		<input type="checkbox"/>			
Flat Smooth				<input type="checkbox"/>	
Smooth	<input type="checkbox"/>		<input type="checkbox"/>	<input type="checkbox"/>	<input type="checkbox"/>
Grooved	<input type="checkbox"/>		<input type="checkbox"/>	<input type="checkbox"/>	<input type="checkbox"/>
Fluted	<input type="checkbox"/>		<input type="checkbox"/>	<input type="checkbox"/>	
Reeded	<input type="checkbox"/>		<input type="checkbox"/>	<input type="checkbox"/>	<input type="checkbox"/>
Wide Reeded				<input type="checkbox"/>	

fascia choice: no fascia

flush end

mitered returns _____

(specify return. see mitered return charges.)

or

• flat smooth and slim round smooth available

• 1³/₈", 1⁷/₈", 2", 2¹/₄" and 3" diameters available
• all profiles

add finials and select finish: _____

choose finish from list of available finishes to the right or submit a custom finish request.

• finials not available for flat smooth and slim round smooth fascias

3 SELECT YOUR DRAPERY STYLE



PINCH PLEAT

overlap

c-rings



RIPPLEFOLD

overlap

butt master

60% 80% 100% 120% fullness

4 COMPLETE YOUR TRAVERSE SPECIFICATIONS

- Mount Type: wall mount ceiling mount
 • may only be used in systems without fascia

COMPONENT COLORS

	manual heavy duty
WHITE	<input type="checkbox"/>
BRONZE	<input type="checkbox"/>

Drapery Draw:

- cord draw
(cord length: 120" standard)
- baton: _____
(baton sold separately)
- cord position: left right
- specify length: _____
(see page 80 of the 2018 Drapery Hardware Catalog)

Direction:

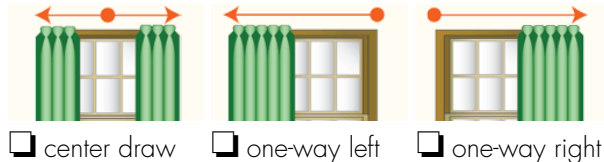

Based on your specified finish we supply track and brackets that best match the finish on your fascia. Please refer to the Finish Reference Guide to the right. If you order a custom match finish, please specify your track color.

Components are included in the per foot track price, as listed in the Retail Price List. Components will match the track color when applicable.

Standard glides are 4 per foot. Standard brackets are 2 end brackets with 1 support bracket for every 3–4 feet of track.

Wood pole profiles available in 1 7/8", 2", 2 1/4" and 3" diameters can be used as fascia.

Spliced fascia will be cut at a 45° angle for an obscure splice upon request.

Spliced fascia can be blended for an additional fee (see Retail Price List). Blended fascia will be properly connected and shipped in one continuous length.

Finish name	Finish code	Recommended track & bracket color
STANDARD FINISHES		
Charred Toasted Oak	800	Bronze
Bronzed Ore	810	Bronze
Sea Salt Black	820	Bronze
Driftwood	830	White
White with Gold Accents	840	White
Soft Brass	850	Bronze
Grayed Brass	860	Bronze
Chalet Gray	870	White
Parchment	880	White
Warm Walnut	890	Bronze
Gilded Red	600	Bronze
Cobalt Bronze	610	Bronze
Weathered Iron	620	Bronze
Ash Gray	630	White
Oil Rubbed Bronze	640	Bronze
Hickory	650	Bronze
Antique White	660	White
Espresso	670	Bronze
Aged Gold	680	Bronze
Champagne	690	Bronze
Graphite	700	Bronze
Tarnished Silver	710	Bronze
Tawny Oak	720	Bronze
Rose Gold	730	Bronze
Smoky Mocha	740	Bronze
Polished Gold	750	Bronze
Rustic Iron	760	Bronze
Bronze Patina	770	Bronze
Hazelwood	780	Bronze
Vintage Bronze	790	Bronze
Bronze	105	Bronze
Bronze with Gold	106	Bronze
Bronze with Gold and Gray	107	Bronze
Flat Black	109	Bronze
Flat Black with Gold	110	Bronze
Silver with Gold	112	White
Walnut Gold	117	Bronze
Dark Walnut Gloss with Gold	126	Bronze
Antique Steel	129	Bronze
Antique Steel with Black Highlights	129B	Bronze
Gray with Gold	150	White
Antique	155	Bronze
Walnut Gold with Gray Accents	200	Bronze
Walnut	240	Bronze
Platinum	250	Bronze
Platinum with Black Highlights	250B	Bronze
Mahogany Rust	270	Bronze
Pewter	320	Bronze
Bronze with Black	330	Bronze
Statuary Bronze with Gold	350G	Bronze

Drapery Hardware & Shade Systems work together to effortlessly control your entire window treatment at the touch of a button.





For more R-TEC Automation® window solution options, visit the Rowley Company website to view our compatible shade systems at:

bit.ly/R-TEC-Automation-Shades

display boards



NEW

TFC20TDB
traverse
display board 2
24"H x 24"W x 6"Deep
wall mount



NEW

RTMDK
R-TEC Automation® display kit (case & kit*)
*R-TEC smart controls not included;
see page 7 for our selection
30¼"H x 26¼"W x 8"Deep (case)

order modules separately:

RTMDK/FMH

R-TEC Automation® motorized metal module

RTMDK/TRACK

R-TEC Automation® track module with fascia*
*1¾" fascia included for reference only; see page 11 for a full list of fascia styles available in this collection, and choose from any of our 50 standard hand painted finishes located on page 34 of the catalog or your own custom finish

RTMLDKIT

slim drapery motor + battery kit*
*works with motorized metal and track modules above



TFC18TTMETAL
metal table top display
12¼"H x 20"W x 8"Deep



TFC18TTMODMETAL
modern metal table top display
12¼"H x 20"W x 8"Deep

PRICING AND TERMS

Prices found in The Finial Company Retail Price List are our suggested retail prices. Prices are subject to change without notice. Due to the U.S. government's current policy on China tariffs, all products are subject to a tariff surcharge as of September 1st, 2019. Prices are quoted exclusive of freight and packaging. The buyer should always inspect the product upon receipt.

IMPORTANT: Please note that your order will be placed with an authorized Finial Company Distributor. While most of the following will generally apply, your distributor may have terms and conditions of sales that will vary from what is stated here.

Estimated Lead Times: Purchase orders are processed once they are received by The Finial Company. Incomplete information will delay processing and shipping. Metal baton draw traverse systems will ship within 5 days of order confirmation. All other traverse systems will ship within 10-15 days of order confirmation.

Shipping (NET Fees): Tracks over 96" must be shipped by common carrier. For current common carrier freight rates go to www.thefinialcompany.com/freightrate. Expedited shipments are not available in all areas. Any additional charges for expedited shipments will be in addition to the published net fees. All orders are F.O.B. Dallas, TX.

The following orders will be subject to actual freight costs:

- shipments going to Alaska, Hawaii, Idaho, Montana, Wyoming, Puerto Rico or any international destination.
- orders that exceed a \$2,500 SRP

Packaging Fees (NET Fees): A net packaging fee of \$10.00 per order will apply to any order that has a track.

RETURNS, CHANGES & CANCELLATIONS

All orders are considered "custom". No changes or cancellations will be accepted later than 24 hours after order is confirmed. All returns must be authorized by The Finial Company customer service department, and are authorized at our discretion, given the circumstances and nature of each custom order.

DAMAGED GOODS

Immediately upon receipt, your order should be inspected to ensure that there is no concealed damage from shipping. Claims on damaged merchandise must be made within 15 days of receipt. No claims after 15 days will be accepted. If your order is damaged in shipping, carriers require that *all* packing materials be kept in order for a representative to inspect the goods. Our policy is that we replace damaged product per the original order.

Please note on the bill of lading if there is any possibility of concealed damaged. If shipping through a 3rd party, distributor is responsible for claiming damages and the remakes will be at charge.

PRODUCT INFORMATION

Manual Traverse Tracks: Manual traverse tracks are sold in 2 foot increments with a 4 foot minimum. We will cut to your specification, but we do not save or ship the fall off.

Motorized Traverse Tracks: Motorized traverse tracks are sold in 2 foot increments with a 4 foot minimum. We will cut to your specification, but we do not save or ship the fall off.

Warranty: 5 year warranty on R-TEC Automation® Slim Drapery Motor, Somfy Glydea® ULTRA motors and Somfy Irisimo™ motors.

Support Brackets: The recommended number of brackets are included on traverse orders. Additional brackets can be purchased for heavier weight draperies and/or corner or bay window installations.

Installation: Mollie bolts and nail anchors are recommended for all installations, but are not included. We strongly recommend using a professional installer for our hardware.

Force Majeure: The Finial Company is not liable for any performance failure that arises from any cause not within its control.

THE FINIAL COMPANY™

January 2021

Traverse Collection Catalog

© 2021 The Finial Company. All rights reserved.