



 **KIRSCH**[®]
DRAPERY HARDWARE

Wrought Iron



SPARKED BY TRADITION

WROUGHT IRON: FOR LOVERS OF OLD WORLD TRADITION

Real Wrought Iron is sand casted
by skilled iron workers.

Time-honored methods and designs.

Hand finished so all unique textures
and qualities are showcased.

Our skilled iron workers still use the time-honored methods to form classic, heavyweight wrought iron products, while protecting the authenticity of the craft and keeping the timeless practice of this beautiful tradition alive. We are proud to keep this remarkable custom alive with the Kirsch Wrought Iron Collection.



CONTENTS

06	Overview
08	1" Finials & Components
18	1 3/8" Finials & Components
28	Helpful Guides
28	AMP™ Motorization
30	Estate™ Overview
32	Bracket Spacing & Mount Option
34	Calculating Drapery Weight
35	Stack Guides
42	Pole Installation, Cutting & Splicing
43	Complete Collection Overview
45	Index



COLLECTION OVERVIEW

6

FINISHES

An alluring range of metals

2

VERSATILE SIZES

1" & 1 $\frac{3}{8}$ "

1

ESTATE™ TRAVERSE ROD SIZES

1 $\frac{3}{8}$ "

1

REMARKABLE COLLECTION

ARCHITRAC™ K-RAIL COMPATIBLE

1 $\frac{3}{8}$ " finials only

AMP™ MOTORIZATION COMPATIBLE

Estate™ Traverse Rods only



2

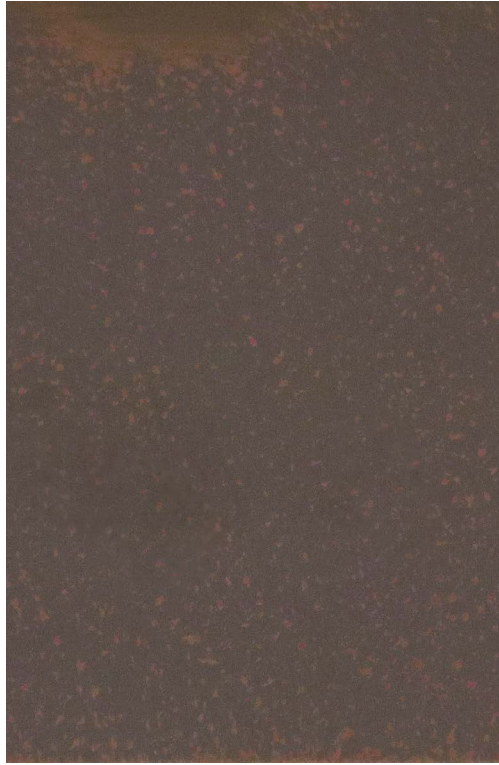

3

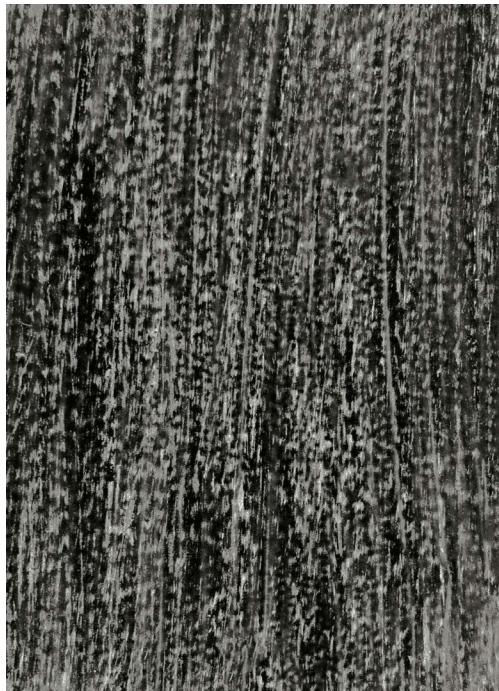

4

- 1 | Black
- 2 | Iron Oxide
- 3 | Rust
- 4 | Graphite | **NEW**
- 5 | Chalk | **NEW**
- 6 | Heirloom Copper | **NEW**



5



6

1" Finials & Endcaps

Axiom

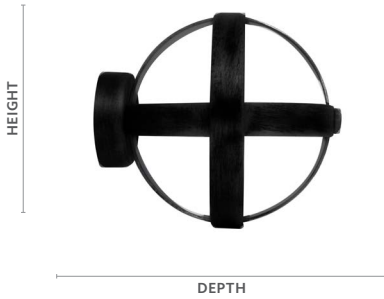

Fits	Dimensions	Quantity per Box
1" Wrought Iron Poles	Depth: 3¼" Height: 2⅞" Width: 2⅞"	5 pairs per box

Product Number & Finish					
56381770	Black	56381804	Graphite	56381802	Iron Oxide
56381803	Chalk	56381805	Heirloom Copper	56381777	Rust

Finial Plugs included.

Darby



Fits	Dimensions	Quantity per Box
1" Wrought Iron Poles	Depth: 2⅞" Height: 1½" Width: 1½"	5 pairs per box

Product Number & Finish					
56384770	Black	56384804	Graphite	56384802	Iron Oxide
56384803	Chalk	56384805	Heirloom Copper	56384777	Rust

Finial Plugs included.

Lincoln



Fits	Dimensions	Quantity per Box
1" Wrought Iron Poles	Depth: 2¼" Height: 1⅞" Width: 1⅞"	5 pairs per box

Product Number & Finish					
56383770	Black	56383804	Graphite	56383802	Iron Oxide
56383803	Chalk	56383805	Heirloom Copper	56383777	Rust

Finial Plugs included.

Otto



Fits	Dimensions	Quantity per Box
1" Wrought Iron Poles	Depth: 2⅞" Height: 2⅞" Width: 2⅞"	5 pairs per box

Product Number & Finish					
56382770	Black	56382804	Graphite	56382802	Iron Oxide
56382803	Chalk	56382805	Heirloom Copper	56382777	Rust

Finial Plugs included.



Otto | Black
Lincoln | Chalk
Darby | Heirloom Copper

1" Finials & Endcaps

Pedestal Ball



Fits	Dimensions	Quantity per Box
1" Wrought Iron Poles	Depth: 4 1/8" Height: 2 7/8" Width: 2 7/8"	5 pairs per box

Product Number & Finish					
56351770	Black	56351804	Graphite	56351802	Iron Oxide
56351803	Chalk	56351805	Heirloom Copper	56351777	Rust

Finial Plugs included.

Petite Faucet



Fits	Dimensions	Quantity per Box
1" Wrought Iron Poles	Depth: 1 3/4" Height: 1 3/4" Width: 1 3/4"	5 pairs per box

Product Number & Finish					
56374770	Black	56374804	Graphite	56374802	Iron Oxide
56374803	Chalk	56374805	Heirloom Copper	56374777	Rust

Finial Plugs included.



1 3/8" Otto | Black
1" Otto | Rust

1" Finials & Endcaps

Petite Modern Ball



Fits	Dimensions	Quantity per Box
1" Wrought Iron Poles	Depth: 2" Height: 1¾" Width: 1¾"	5 pairs per box

Product Number & Finish					
56373770	Black	56373804	Graphite	56373802	Iron Oxide
56373803	Chalk	56373805	Heirloom Copper	56373777	Rust

Finial Plugs included.

Ponce



Fits	Dimensions	Quantity per Box
1" Wrought Iron Poles	Depth: 4 ¹³ / ₁₆ " Height: 1½" Width: 1½"	5 pairs per box

Product Number & Finish					
56385770	Black	56385804	Graphite	56385802	Iron Oxide
56385803	Chalk	56385805	Heirloom Copper	56385777	Rust

Finial Plugs included.

Endcap



Fits	Dimensions	Quantity per Box
1" Wrought Iron Poles	Depth: 7/8" Height: 1 1/8" Width: 1 1/8"	5 pairs per box

Product Number & Finish					
56358770	Black	56358804	Graphite	56358802	Iron Oxide
56358803	Chalk	56358805	Heirloom Copper	56358777	Rust

Finial Plugs included.

1" Poles

6' Pole



Diameter	Length	Quantity per Box
1"	6'	6 pieces per box

Product Number & Finish

56359770 Black	56359804 Graphite	56359802 Iron Oxide
56359803 Chalk	56359805 Heirloom Copper	56359777 Rust

8' Pole



Diameter	Length	Quantity per Box
1"	8'	6 pieces per box

Product Number & Finish

56360770 Black	56360804 Graphite	56360802 Iron Oxide
56360803 Chalk	56360805 Heirloom Copper	56360777 Rust

1" Rings

Ring



Fits		Dimensions		Quantity per Box	
1" Wrought Iron Poles		Internal: 1½" External: 2½" External to eyelet: 2¾"		10 bags per box - 7 rings per bag	
Product Number & Finish					
56361770	Black	56361804	Graphite	56361802	Iron Oxide
56361803	Chalk	56361805	Heirloom Copper	56361777	Rust

Bypass C-Ring



Fits		Dimensions		Quantity per Box	
1" Wrought Iron Poles		Internal: 1½" External: 2½" External to eyelet: 2¾"		10 bags per box - 7 rings per bag	
Product Number & Finish					
56371770	Black	56371804	Graphite	56371802	Iron Oxide
56371803	Chalk	56371805	Heirloom Copper	56371777	Rust

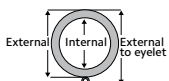

Use the measurement guide to the left to help determine the correct dimensions for your selected product.

1" Brackets

3½" Return Bracket



Fits		Dimensions		Quantity per Box	
1" Wrought Iron Poles		Depth: 4¼"	Wall to Pole: 3"	5 pieces per box	
		Height: 4"	Return: 3½"		
		Width: ¾"			
Product Number & Finish					
56362770	Black	56362804	Graphite	56362802	Iron Oxide
56362803	Chalk	56362805	Heirloom Copper	56362777	Rust

5⅜" Return Bracket



Fits		Dimensions		Quantity per Box	
1" Wrought Iron Poles		Depth: 6¼"	Wall to Pole: 4⅞"	5 pieces per box	
		Height: 4¼"	Return: 5⅜"		
		Width: ¾"			
Product Number & Finish					
56363770	Black	56363804	Graphite	56363802	Iron Oxide
56363803	Chalk	56363805	Heirloom Copper	56363777	Rust

Center Bypass Bracket



Fits		Dimensions		Quantity per Box	
1" Wrought Iron Poles		Depth: 4¼"	Wall to Pole: 3"	5 pieces per box	
		Height: 4"	Return: 3½"		
		Width: ¾"			
Product Number & Finish					
56372770	Black	56372804	Graphite	56372802	Iron Oxide
56372803	Chalk	56372805	Heirloom Copper	56372777	Rust

Double Bracket



Fits		Dimensions		Quantity per Box	
1" Wrought Iron Poles		Depth: 7½"	Wall to Pole: 3"	5 pieces per box	
		Height: 5⅝"	Inner Return: 3½"		
		Width: ¾"	Outer Return: 6½"		
Product Number & Finish					
56365770	Black	56365804	Graphite	56365802	Iron Oxide
56365803	Chalk	56365805	Heirloom Copper	56365777	Rust

1" Brackets, Accessories & Components

Inside Mount Socket



Fits	Dimensions	Quantity per Box
1" Wrought Iron Poles	Depth: 1" Height: 2" Width: 2"	5 pairs per box

Product Number & Finish					
56370770	Black	56370804	Graphite	56370802	Iron Oxide
56370803	Chalk	56370805	Heirloom Copper	56370805	Rust

Mounts a 1" rod between two facing walls.

Swivel Socket



Fits	Dimensions	Quantity per Box
1" Wrought Iron Poles	Partial Length: 1½" Plug Length: ¾" Full Length: 2½"	5 pieces per box

Product Number & Finish					
56367770	Black	56367804	Graphite	56367802	Iron Oxide
56367803	Chalk	56367805	Heirloom Copper	56367777	Rust

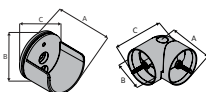

Use the measurement guide to the left to help determine the correct dimensions for your selected product.

1" Accessories & Components

36" Baton with Bypass C-Ring



Fits		Dimensions		Quantity per Box	
1" Wrought Iron Poles		36" long		6 pieces per box	
Product Number & Finish					
56375770	Black	56375804	Graphite	56375802	Iron Oxide
56375803	Chalk	56375805	Heirloom Copper	56375777	Rust

Finial Plug

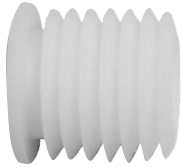

Fits		Quantity per Box	
1" Wrought Iron Poles		50 pieces per box	
Product Number & Finish			
56369058	White		

Internal Rod Splice



Fits		Quantity per Box	
1" Wrought Iron Poles		5 pieces per box	
Product Number & Finish			
56366061	Zinc Plated		

Connects two poles together for larger width options.



1 3/8" Finials & Endcaps

Axiom

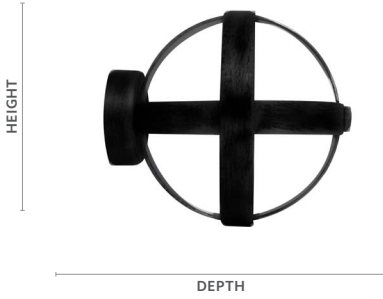

Fits	Dimensions	Quantity per Box
1 3/8" Wrought Iron Poles	Depth: 3 13/16"	5 pairs per box
1 3/8" Estate™ Traverse Rods	Height: 3 3/8"	
1 3/8" K-Rail Traverse Rods	Width: 3 3/8"	

Product Number & Finish					
56481770	Black	56481804	Graphite	56481802	Iron Oxide
56481803	Chalk	56481805	Heirloom Copper	56481777	Rust

Finial Plugs included.

Darby



Fits	Dimensions	Quantity per Box
1 3/8" Wrought Iron Poles	Depth: 3 1/4"	5 pairs per box
1 3/8" Estate™ Traverse Rods	Height: 2"	
1 3/8" K-Rail Traverse Rods	Width: 2"	

Product Number & Finish					
56484770	Black	56484804	Graphite	56484802	Iron Oxide
56484803	Chalk	56484805	Heirloom Copper	56484777	Rust

Finial Plugs included.



Axiom | Graphite

1 3/8" Finials & Endcaps

Lincoln



Fits	Dimensions	Quantity per Box
1 3/8" Wrought Iron Poles 1 3/8" Estate™ Traverse Rods 1 3/8" K-Rail Traverse Rods	Depth: 2 3/8" Height: 2 1/8" Width: 2 1/8"	5 pairs per box

Product Number & Finish					
56483770	Black	56483804	Graphite	56483802	Iron Oxide
56483803	Chalk	56483805	Heirloom Copper	56483777	Rust

Finial Plugs included.

Otto



Fits	Dimensions	Quantity per Box
1 3/8" Wrought Iron Poles 1 3/8" Estate™ Traverse Rods 1 3/8" K-Rail Traverse Rods	Depth: 2 7/16" Height: 3 1/4" Width: 3 1/4"	5 pairs per box

Product Number & Finish					
56482770	Black	56482804	Graphite	56482802	Iron Oxide
56482803	Chalk	56482805	Heirloom Copper	56482777	Rust

Finial Plugs included.

Pedestal Ball



Fits	Dimensions	Quantity per Box
1 3/8" Wrought Iron Poles 1 3/8" Estate™ Traverse Rods 1 3/8" K-Rail Traverse Rods	Depth: 4 7/8" Height: 3 3/8" Width: 3 3/8"	5 pairs per box

Product Number & Finish					
56451770	Black	56451804	Graphite	56451802	Iron Oxide
56451803	Chalk	56451805	Heirloom Copper	56451777	Rust

Finial Plugs included.

Petite Faucet



Fits	Dimensions	Quantity per Box
1 3/8" Wrought Iron Poles 1 3/8" Estate™ Traverse Rods 1 3/8" K-Rail Traverse Rods	Depth: 2 3/8" Height: 2 3/16" Width: 2 3/16"	5 pairs per box

Product Number & Finish					
56474770	Black	56474804	Graphite	56474802	Iron Oxide
56474803	Chalk	56474805	Heirloom Copper	56474777	Rust

Finial Plugs included.

1 3/8" Finials & Endcaps

Petite Modern Ball



Fits		Dimensions		Quantity per Box	
1 3/8" Wrought Iron Poles		Depth: 3 3/8"		5 pairs per box	
1 3/8" Estate™ Traverse Rods		Height: 1 15/16"			
1 3/8" K-Rail Traverse Rods		Width: 1 15/16"			
Product Number & Finish					
56473770	Black	56473804	Graphite	56473802	Iron Oxide
56473803	Chalk	56473805	Heirloom Copper	56473777	Rust

Finial Plugs included.

Ponce



Fits		Dimensions		Quantity per Box	
1 3/8" Wrought Iron Poles		Depth: 5 1/2"		5 pairs per box	
1 3/8" Estate™ Traverse Rods		Height: 1 1/4"			
1 3/8" K-Rail Traverse Rods		Width: 1 1/4"			
Product Number & Finish					
56485770	Black	56485804	Graphite	56485802	Iron Oxide
56485803	Chalk	56485805	Heirloom Copper	56485777	Rust

Finial Plugs included.

Endcap



Fits		Dimensions		Quantity per Box	
1 3/8" Wrought Iron Poles		Depth: 1 1/8"		5 pairs per box	
1 3/8" Estate™ Traverse Rods		Height: 2 1/2"			
1 3/8" K-Rail Traverse Rods		Width: 2 1/2"			
Product Number & Finish					
56458770	Black	56458804	Graphite	56458802	Iron Oxide
56458803	Chalk	56458805	Heirloom Copper	56458777	Rust

Finial Plugs included.

1 3/8" Poles

6' Pole



Diameter	Length	Quantity per Box
1 3/8"	6'	6 pieces per box

Product Number & Finish

56459770	Black	56459804	Graphite	56459802	Iron Oxide
56459803	Chalk	56459805	Heirloom Copper	56459777	Rust

8' Pole



Diameter	Dimensions	Quantity per Box
1 3/8"	8'	6 pieces per box

Product Number & Finish

56460770	Black	56460804	Graphite	56460802	Iron Oxide
56460803	Chalk	56460805	Heirloom Copper	56460777	Rust



1 3/8" Estate™ Traverse Rod

To learn more about the technical specs on Estate Traverse Rods and AMP™ Motorization, see pages 28-29.

Assembled Set with Slides



Manual Traversing Rods with Selected Carriers

Unit of Measure

Foot

AMP™ Motorization Upcharge

Charger, item #62201300 included. Remotes sold separately.

Product Number & Finish

83697770	Black	83697804	Graphite	83697802	Iron Oxide
83697803	Chalk	83697805	Heirloom Copper	83697777	Rust

Assembled Set with Wheeled Ripplefold™ Carriers



Manual Traversing Rods with Selected Carriers

Unit of Measure

Foot

AMP™ Motorization Upcharge

Charger, item #62201300 included. Remotes sold separately.

Product Number & Finish

83698770	Black	83698804	Graphite	83698802	Iron Oxide
83698803	Chalk	83698805	Heirloom Copper	83698777	Rust

1 3/8" Estate™ Keystone



Fits

Quantity per Box

1 3/8" Estate™ Traverse Rods 25 pieces per box

Product Number & Finish

1833770	Black	1833804	Graphite	1833802	Iron Oxide
1833803	Chalk	1833805	Heirloom Copper	1833777	Rust

Double Bracket

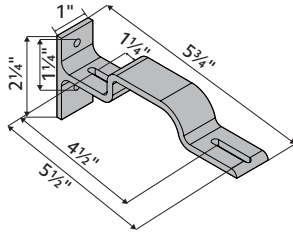

Fits	Dimensions	Quantity per Box
1 3/8" Estate™ Traverse Rods 2" Estate™ Traverse Rods	Depth: 5 3/4" Height: 2 1/4" Width: 1"	10 pieces per box
Product Number & Finish		
71134110 Satin Brass		



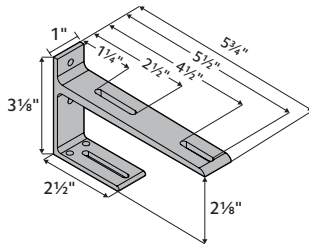





Double Bracket



Fits	Dimensions	Quantity per Box
1 3/8" Estate™ Traverse Rods 2" Estate™ Traverse Rods	Depth: 5 3/4" Height: 3 1/8" Width: 1"	10 pieces per box
Product Number & Finish		
71132062 Antique Brass	71132110 Satin Brass	
71132006 Black	71132012 Satin Nickel	

1 3/8" Estate™ Traverse Rod Components

To learn more about the technical specs on Estate Traverse Rods and AMP™ Motorization, see pages 28-29.

Item	Product No. & Finish	Description	Quantity Per Box
	62101000 White 62101010 Black	AMP Remote Control RF 2W 15 Channel	1 piece per box
	62201300 White	AMP Battery Charger 16.5V/0.89A	1 piece per box
	62102000 White	AMP Gateway USB Bridge	1 piece per box
	62109000 White	AMP Wall Switch Surface RF 2W 15 Channel	1 piece per box
	62108000 White	AMP Wall Switch RF 2W 15 Channel	1 piece per box
	2989899000	15" Cable Assembly	10 pieces per box
	1026661	4' Cable Assembly	10 pieces per box
	2989901000	10' Cable Assembly	10 pieces per box
	2989902000	20' Cable Assembly	10 pieces per box

1 3/8" Rings

Ring



Fits		Dimensions		Quantity per Box	
1 3/8" Wrought Iron Poles		Internal: 2" External: 2 1/2" External to eyelet: 2 13/16"		10 bags per box	
Product Number & Finish					
56461770	Black	56461804	Graphite	56461802	Iron Oxide
56461803	Chalk	56461805	Heirloom Copper	56461777	Rust

Bypass C-Ring



Fits		Dimensions		Quantity per Box	
1 3/8" Wrought Iron Poles		Internal: 2" External: 2 1/2" External to eyelet: 2 13/16"		10 bags per box	
Product Number & Finish					
56471770	Black	56471804	Graphite	56471802	Iron Oxide
56471803	Chalk	56471805	Heirloom Copper	56471777	Rust

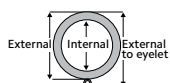

1 3/8" Brackets

3 1/2" Return Bracket



Fits	Dimensions		Quantity per Box
1 3/8" Wrought Iron Poles	Depth: 4 1/2" Height: 4 1/8" Width: 1 1/6"	Wall to Pole: 3" Return: 3 1/2"	5 pieces per box

Product Number & Finish				
56462770	Black	56462804	Graphite	56462802 Iron Oxide
56462803	Chalk	56462805	Heirloom Copper	56462777 Rust

5 3/8" Return Bracket



Fits	Dimensions		Quantity per Box
1 3/8" Wrought Iron Poles	Depth: 6 1/2" Height: 4 5/16" Width: 1 1/6"	Wall to Pole: 4 3/8" Return: 5 3/8"	5 pieces per box

Product Number & Finish				
56463770	Black	56463804	Graphite	56463802 Iron Oxide
56463803	Chalk	56463805	Heirloom Copper	56463777 Rust

Center Bypass Bracket



Fits	Dimensions		Quantity per Box
1 3/8" Wrought Iron Poles	Depth: 4 3/8" Height: 4 1/8" Width: 1 1/6"	Wall to Pole: 3" Return: 3 1/2"	5 pieces per box

Product Number & Finish				
56472770	Black	56472804	Graphite	56472802 Iron Oxide
56472803	Chalk	56472805	Heirloom Copper	56472777 Rust

Double Bracket



Fits	Dimensions		Quantity per Box
1 3/8" Wrought Iron Poles	Depth: 7 1/16" Height: 5 5/8" Width: 5/8"	Wall to Pole: 1 3/16" Inner Return: 3 1/2" Outer Return: 6 1/2"	5 pieces per box

Product Number & Finish				
56465770	Black	56465804	Graphite	56465802 Iron Oxide
56465803	Chalk	56465805	Heirloom Copper	56465777 Rust



Use the measurement guide to the left to help determine the correct dimensions for your selected product.

1 3/8" Bracket, Accessories & Components

Inside Mount Socket



Fits	Dimensions	Quantity per Box
1 3/8" Wrought Iron Poles	Depth: 1 1/16" Height: 2 3/8" Width: 2 3/8"	5 pairs per box

Product Number & Finish					
56470770	Black	56470804	Graphite	56470802	Iron Oxide
56470803	Chalk	56470805	Heirloom Copper	56470777	Rust

Mounts a 1" rod between two facing walls.

Swivel Socket



Fits	Dimensions	Quantity per Box
1 3/8" Wrought Iron Poles	Partial Length: 2 9/16" Plug Length: 1 5/16" Full Length: 3 1/2"	5 pieces per box

Product Number & Finish					
56467770	Black	56467804	Graphite	56467802	Iron Oxide
56467803	Chalk	56467805	Heirloom Copper	56467777	Rust

36" Baton with Bypass C-Ring



Fits	Dimensions	Quantity per Box
1 3/8" Wrought Iron Poles	36" long	6 pieces per box

Product Number & Finish					
56376770	Black	56376804	Graphite	56376802	Iron Oxide
56376803	Chalk	56376805	Heirloom Copper	56376777	Rust

Finial Plug



Fits	Quantity per Box
1 3/8" Wrought Iron Poles	50 pieces per box

Product Number & Finish	
56469058	White

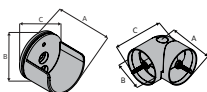

1" & 1 3/8" Accessories & Components

Internal Rod Splice



Fits	Quantity per Box
------	------------------

1 3/8" Wrought Iron Poles	5 pieces per box
---------------------------	------------------

Product Number & Finish

56466061 Zinc Plated

Connects two poles together for larger width options.

Teflon Tape

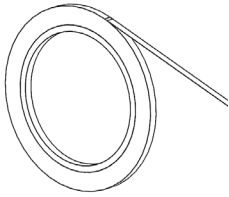

Dimensions	Quantity per Box
------------	------------------

54' per roll	1 roll per box
--------------	----------------

Product Number & Finish

84990000 Clear

Teflon tape is used on stationary poles to help rings slide smoothly across the pole.

AMP™ Motorization

Why AMP™?

The slim design of the quiet, yet powerful motor and the position on the track allows the motor to tuck seamlessly behind your drapery panel so you'll never have to sacrifice your style or comfort. For safety measures, you're able to move the draperies with a gentle tug, allowing for operation when a remote is not present or if a guest is unaware of the motorization feature. The dual battery and AC power sources allows operation in case of a power outage so draperies may be opened in the event of an emergency. AMP™ Motorization is available on our most popular traversing tracks, Estate and Architrac® Series 94001 and in drapery header styles Ripplefold™ and pleated for a variety of styling options. This is comfortable living at its finest.

For AMP™ Motorization brochure, programming instructions and installation instructions, please visit the drapery hardware resource library at kirsch.com.

Benefits & Features

AMP™ Motorization

- Motor mounts to the back of the track which allows a seamless look between motorized and manual traverse rods
- Drapery fabrication does not need to change between manually controlled draperies and motorized draperies; No additional returns or any special instructions
- Limits are set automatically after installation
- Remote control is radio frequency and easily pairs with the motor
- Tug feature; when drapery is pulled the motor will traverse the drapery
- AMP™ App with AMP™ USB Bridge
- Architrac® Series 94001 Rods with AMP™ cannot be bent or curved

Frequently Asked Questions

What is the weight capacity?

64 lbs Motor is rated to 64 lbs. Be sure not to exceed the Estate or Architrac track specifications to ensure your motor operates optimally.

Can you double the weight capacity by using two motors?

No Only use one motor per rod.

Does AMP™ offer limit setting?

Yes The motor automatically sets its limits.

Does AMP™ offer touch control?

Yes The tug feature allows you to pull on the drapery and the motor will automatically open or close your draperies.

How long is the power cord?

6 ft The durable, non-extendable power cord is extra long for out of reach places. Any extra can be rolled and secured for a tidy look. Cable extensions are available in 15", 4', 10' and 20' lengths to reach outlets that are farther away from the motor.

Is there a wall switch?

Yes There are Flush Mount and Surface Mount Wall Switches available.

Does AMP™ offer a warranty?

Yes See the Kirsch Warranty document for more information.

Download the AMP™ APP to get started



AMP™ Motorization Overview

Overview

- Soft start/stop & manual operation
- Tug feature: when drapery is pulled the motor will traverse the drapery
- Automatic limits on end stop
- Favorite/intermediate position
- Dry contact for external control
- RF Remote and wall switches
- Setting with buttons on motor units
- Setting with external dry contact switch
- LED Indicators
- One-Way and Two-Way Draw
- Pleated
- Ripplefold™
- AMP™ App with AMP™ USB Bridge

Available Colors

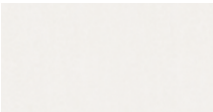

White

Side View



Front View

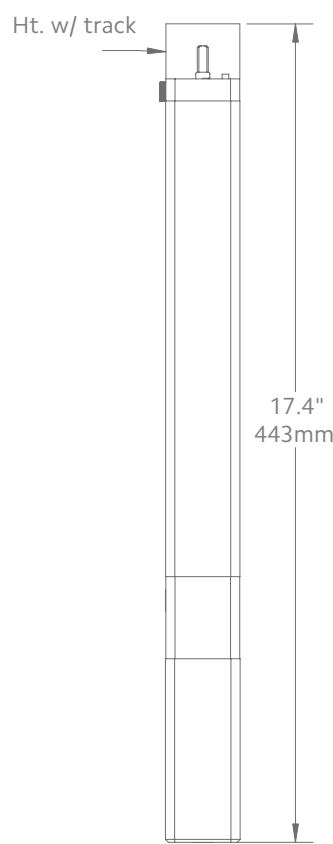

Bottom View

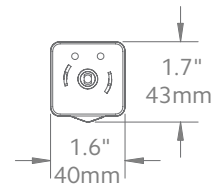

Motor Unit	Product No.
AMP™ Drapery Motor	62001300

Technical Specs	AMP™ Motor
Power Supply	DC 16.5V-0.89A (100-240VAC 50/60Hz 0.5A)
Amperage	2.55Ah
Average Linear Speed	7.8inches/sec
Power Consumption	40 watts
Torque	1.2Nm
Power Cable Length	6 feet
Variable Speed	80, 100 & 120 rpm
Certifications	UL/CE
Max. Track Length	Estate™ - 16 ft Architrac™ 94001 - 16 ft
Max. Load	64 lbs

Follow track specifications for drapery weight.



Estate™ Overview

To help determine which system is right for your project, use the guideline below to select the best fit. For more detailed information about each track, please visit our resource library at kirsch.com.

Estate™ Series	Buckingham®	Designer Metals™	Wood Trends™	Wrought Iron	Varia	Chroma
What is your preferred size?						
1 3/8"	•	•	•	•		
2"	•	•	•		•	•
What is your preferred Draw type?						
Motorized	•	•	•	•	•	•
Manual	•	•	•	•	•	•
What is your preferred Drapery Heading type?						
Pleated	•	•	•	•	•	•
Ripplefold™	•	•	•	•	•	•
What is your mounting location?						
Ceiling Mount*	•	•	•	•	•	•
Wall Mount	•	•	•	•	•	•
What is your preferred look?						
With rings		•				
Without rings	•	•	•	•	•	•

*Final choices may be limited for ceiling mounted Estate™ Rods.

Track Performance Data

Style	Heading Style	Mount	Draw	Minimum Track Length	Maximum Track Length	Minimum Fabric Weight	Lbs. per Ft.
 83611 1 3/8" Estate™ Manual or Motorized Draw	Pleated, Ripplefold™	Ceiling, Wall	One-Way	18 in	16 ft	64 lbs	4
			Two-Way	18 in	16 ft	64 lbs	4
 93601 2" Estate™ Manual or Motorized Draw	Pleated, Ripplefold™	Ceiling, Wall	One-Way	18 in	16 ft	64 lbs	4
			Two-Way	18 in	16 ft	64 lbs	4

*Maximum track lengths and maximum fabric weight do not apply to curved track. Check with customer service for feasibility. Send complete specifications and fabric weight.

Splices & Keystones per Track

Track Length	Number of Splices	Keystones Included
8 ft. to 16 ft.	1	1

Operating Systems

Motorized Draw

AMP™ Motorization

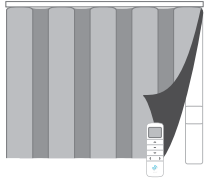

- Easy to use
- Quiet, powerful motor
- Pleated or Ripplefold™
- For Estate™ Traverse Rods or Architrac® Series 94001
- For more information, see page 46

Manual Draw

Cord Draw

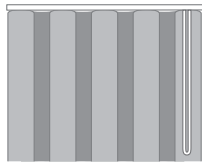

- Easy to use
- Pleated or Ripplefold™

Hand/Baton Draw



- Easy to use
- A gentle tug allows drapery to glide across track
- Pleated or Ripplefold™

Baton Duplex Draw

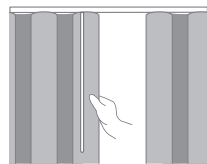

- Easy to use
- Used on split draw rods
- Pleated or Ripplefold™
- When the baton is pulled on one stack, draperies on both sides of the traverse rod open or close.

Header Styles

Ripplefold™

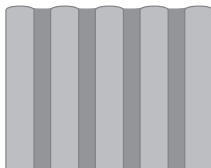

- Panels can be pressed flat, yet fall into fold
- No hooks or pins
- Headings are suspended under track
- Stack back is less than conventional pleated draperies
- Draperies snap on/off carriers for easy installation
- Interior drapery appearance is identical to exterior-facing appearance

Pleated

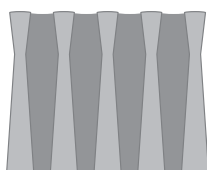

- A classic header option
- Can be used with most track systems using slip-in or pin-on hooks
- Headings can be suspended under the track or over the face of the track to conceal hardware
- Four carries per foot is standard, additional carriers or rings can be ordered.

Bracket Spacing & Mount Options

Place bracket at each end, place next bracket a maximum of 24" from first, then place remaining brackets at 48" intervals over the remainder of the track. Spacing may need to be shortened for heavier draperies. All mounting options are compatible with our AMP™ Motorization.



Wall Mount using parts:

To achieve this look, order Estate rod, wall mount and all components will be included.

94129061
Zinc

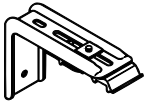

or

1856973
Satin Nickel

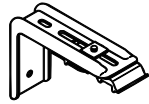

or

1856978
Brushed Bronze

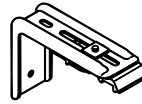

or

1857324
Black

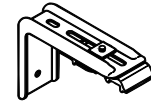

1 3/8" Wall Mount

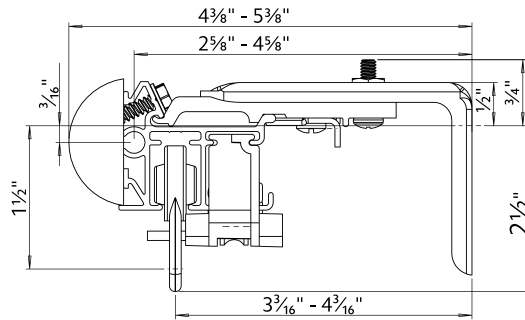

Ceiling Mount using parts:

To achieve this look, order Estate rod, ceiling mounted. 94130xxx brackets are included with the rod. Then order item 1796061 ceiling mount bracket in the quantity needed based on the bracket spacing drawing on page 32.

94130xxx



&

1796061

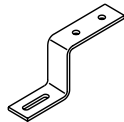

1 3/8" Ceiling Mount

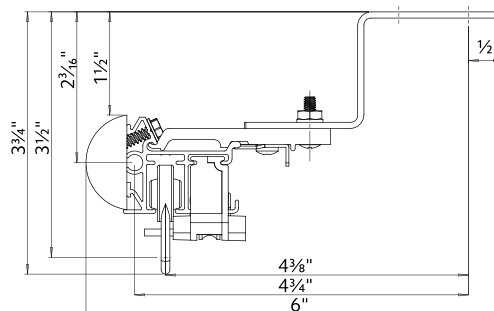

Double Wall Mount using parts:

To achieve this look, order Estate rod, ceiling mounted. 94130xxx brackets are included with the rod. Then order one, item 94125xxx double bracket and two, item 1796061 ceiling mount brackets multiplied by the quantity needed based on the bracket spacing drawing on page 32.

94125xxx

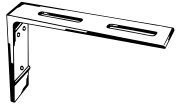

⊗

1796061

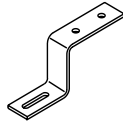

⊗

94130xxx



1 3/8" Double Wall Mount

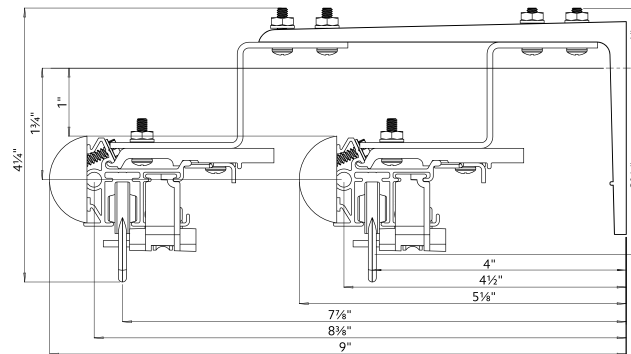

Double Wall Mount using parts:

To achieve this look, order Estate rod ceiling mounted. 94130xxx brackets are included with the rod. Then order one, item 71134110 double bracket in the quantity needed based on the bracket spacing drawing on page 32.

71134110

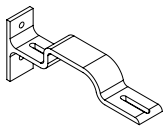

⊗

94130xxx

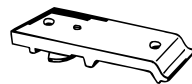

1 3/8" Front & 1 3/8" Back Double Wall Mount

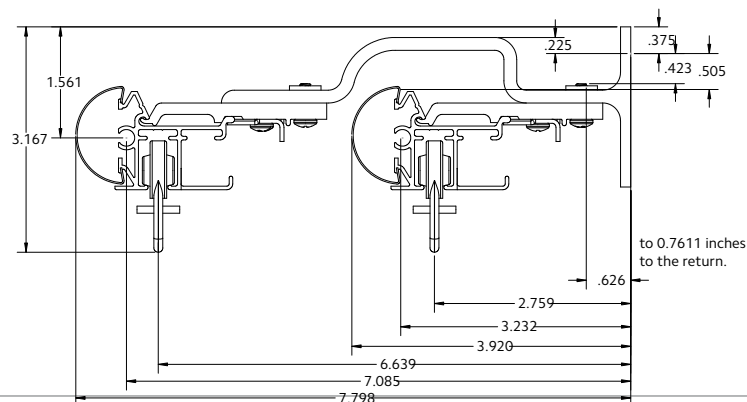

Calculating Drapery Weight

1. Fabric Weight

Some fabric samples list on the back of the swatch the weight listed in Ounces/SqYd (ounces per square yard). Call the manufacturer for the weight if not listed.

2. Lining Weight

Most drapery linings are 2oz - 4oz per square yard.

Drapery Weight Formula

Total Square Yards = (total yards x 36 x fabric width) ÷ 1296 (1-square yard)

Weight = total square yards x weight in ounces per SqYd ÷ 16 oz in lb

Example 32 yards of 54" wide fabric weighing 14 oz/SqYd
Total square yards = (32 x 36 x 54) = 62,208 ÷ 1296 = 48 SqYds
Weight = (48 x 14oz) = 672 ÷ 16 = 42 lbs

Lining Weight Formula

Total Square Yards = (total yards x 36 x fabric width) ÷ 1296 (1-square yard)

Weight = total square yards x weight in ounces per SqYd ÷ 16 oz in lb

Example 32 yards of 54" wide fabric weighing 6 oz/SqYd
Total square yards = (32 x 36 x 54) = 62,208 ÷ 1296 = 48 SqYds
Weight = (48 x 4oz) = 192 ÷ 16 = 12 lbs

Fabrics by Weight

Contact the fabric manufacturer for your specific fabric weight.

Fabric Type	Weight per Square Yard
Drapery Lining	2-4oz
Interlining	5-6oz
Blackout Lining	6-10oz
Bump Lining	12-14oz
Silks	2-4oz
Chintz	2-4oz
Printed Cottons	4-6oz
Linens	6-10oz
Jacquards	10-14oz
Velvets	14-18oz

Stack Guides

Pleated Stack Guide (for 16 mm carriers)

Note: Stack size is estimated. Type of fabric used could alter these measurements.

Size of Track (in inches)	5 carriers per foot 3x fullness		4 carriers per foot 2½x fullness		3 carriers per foot 2x fullness	
	Stackback One-Way	Stackback Two-Way (per side)	Stackback One-Way	Stackback Two-Way (per side)	Stackback One-Way	Stackback Two-Way (per side)
18	11.75	8.75	10.5	8.5	10.5	8.5
24	13	9.25	11.75	8.75	10.5	8.5
30	15.75	10.5	13	9.25	11.75	8.75
36	17	11.25	14.5	10	13	9.25
42	18.5	12	15.75	10.5	14.5	10
48	19.75	12.5	17	11.25	14.5	10
54	22.25	14	18.5	12	15.75	10.5
60	23.75	14.5	19.75	12.5	17	11.25
66	25	15.25	21	13.25	18.5	12
72	26.25	16	22.25	14	18.5	12
78	29	17.25	23.75	14.5	19.75	12.5
84	30.25	18	25	15.25	21	13.25
90	31.5	18.5	26.25	16	22.25	14
96	33	19.25	27.5	16.5	22.25	14
102	35.5	20.5	29	17.25	23.75	14.5
108	36.75	21.25	30.25	18	25	15.25
114	38.25	21.75	31.5	18.5	26.25	16
120	39.5	22.5	33	19.25	26.25	16
126	42.25	23.75	34.25	19.75	27.5	16.5
132	43.5	24.5	35.5	20.5	29	17.25
138	44.75	25.25	36.75	21.25	30.25	18
144	46	25.75	38.25	21.75	30.25	18
150	48.75	27	39.5	22.5	31.5	18.5
156	50	27.75	40.75	23.25	33	19.25
162	51.5	28.5	42.25	23.75	34.25	19.75
168	52.75	29	43.5	24.5	34.25	19.75
174	55.25	30.5	44.75	25.25	35.5	20.5
180	56.75	31	46	25.75	36.75	21.25
186	58	31.75	47.5	26.5	38.25	21.75
192	59.25	32.5	48.75	27	38.25	21.75
198	62	33.75	50	27.75	39.5	22.5
204	63.25	34.5	51.5	28.5	40.75	23.25
210	64.5	35	52.75	29	42.25	23.75
216	66	35.75	54	29.75	42.25	23.75
222	68.5	37	55.25	30.5	43.5	24.5
228	69.75	37.75	56.75	31	44.75	25.25
234	71.25	38.25	58	31.75	46	25.75
240	72.5	39	59.25	32.5	46	25.75

Ripplefold™ Stack Guide for Butt Master 84111xxx

Note: Stack size is estimated. Type of fabric used could alter these measurements. Please refer to the Ripplefold Fabrication Manual for more information.

120% Fullness	100% Fullness	80% Fullness	60% Fullness	Number of factory snaps	Snap Tape Length (less return length)*	Panel Stackback
13⅜	15⅜	17⅞	18⅞	8	32½	5½
17⅜	19⅝	21⅞	24⅞	10	41	6½
21⅞	23⅞	26⅝	29⅝	12	49½	7½
24⅞	28⅞	31⅞	34⅝	14	58	8¾
28⅝	32⅝	36⅞	39⅞	16	66½	9¾
32⅝	36⅝	40⅞	45⅞	18	75	11
36⅞	40⅞	45⅝	50⅞	20	83½	12
39⅞	45⅞	50⅝	55⅞	22	92	13
45⅝	49⅝	55⅞	60⅞	24	100½	14¼
47⅝	53⅝	59⅞	66⅞	26	109	15¼
51⅞	57⅞	64⅞	71⅞	28	117½	16½
54⅞	62⅞	69⅞	76⅞	30	126	17½
58⅝	66⅝	74⅞	81⅞	32	134½	18½
62⅝	70⅝	78⅞	87⅞	34	143	19¾
66⅞	74⅞	83⅝	92⅞	36	151½	20¾
69⅞	79⅞	88⅝	97⅞	38	160	22
73⅝	83⅝	93⅞	102⅞	40	168½	23
77⅝	87⅝	97⅞	108⅞	42	177	24
81⅞	91⅞	102⅝	113⅞	44	185½	25¼
84⅞	96⅞	107⅝	118⅞	46	194	26¼
88⅝	100⅝	112⅞	123⅞	48	202½	27½
92⅝	104⅝	116⅞	129⅞	50	211	28½
96⅞	108⅞	121⅝	134⅝	52	219½	29½
99⅞	113⅞	126⅝	139⅝	52	228	30¾
103⅝	117⅝	131⅞	144⅞	54	236½	31¾
107⅝	121⅝	135⅞	150⅞	56	245	33
111⅞	125⅞	140⅞	155⅝	58	253½	34
114⅞	130⅞	145⅞	160⅞	60	262	35
118⅝	134⅝	150⅞	165⅞	62	270½	36¼
122⅝	138⅝	154⅞	171⅞	64	279	37¼
126⅞	142⅞	159⅞	176⅝	66	287½	38½
129⅞	147⅞	164⅝	181⅞	68	296	39 ½
133⅝	151⅝	169⅞	186⅞	70	304½	40½
137⅝	155⅝	173⅞	192⅞	72	313	41¾
141⅞	159⅞	178⅞	197⅝	74	321½	42¾
144⅞	164⅞	183⅞	202⅞	76	330	44

Ripplefold™ Stack Guide for Butt Master 8411xxx

Note: Stack size is estimated. Type of fabric used could alter these measurements. Please refer to the Ripplefold Fabrication Manual for more information.

120% Fullness	100% Fullness	80% Fullness	60% Fullness	Number of factory snaps	Snap Tape Length (less return length)*	Panel Stackback
148⅝	168⅝	188⅝	207⅝	78	338½	45
152⅝	176⅝	192⅝	213⅝	80	347	46
156⅝	176⅝	197⅝	218⅝	84	355½	47¼
159⅝	181⅝	202⅝	223⅝	86	364	48¼
163⅝	185⅝	207⅝	228⅝	88	372½	49½
167⅝	189⅝	211⅝	234⅝	90	381	50½
171⅝	193⅝	216⅝	239⅝	92	389½	51½
174⅝	198⅝	221⅝	244⅝	94	398	52¾
178⅝	202⅝	226⅝	249⅝	96	406½	53¾
182⅝	206⅝	230⅝	255⅝	98	415	55
186⅝	210⅝	235⅝	260⅝	100	423½	56
189⅝	215⅝	240⅝	265⅝	102	432	57
193⅝	219⅝	245⅝	270⅝	104	440½	58¼
197⅝	223⅝	249⅝	276⅝	106	449	59¼
201⅝	227⅝	254⅝	281⅝	108	457½	60½
204⅝	232⅝	259⅝	286⅝	110	466	61½
208⅝	236⅝	264⅝	291⅝	112	474½	62 ½
212⅝	240⅝	268⅝	297⅝	114	483	63¾
216⅝	244⅝	273⅝	302⅝	116	491½	64¾
219⅝	249⅝	278⅝	307⅝	118	500	66
223⅝	253⅝	283⅝	312⅝	120	508½	67
227⅝	257⅝	287⅝	318⅝	122	517	68
231⅝	261⅝	292⅝	323⅝	124	525½	69¼
234⅝	266⅝	297⅝	328⅝	126	534	70¼
238⅝	270⅝	302⅝	333⅝	128	542½	71½
242⅝	274⅝	306⅝	339⅝	130	551	72½
246⅝	278⅝	311⅝	344⅝	132	559½	73½
249⅝	283⅝	316⅝	349⅝	134	568	74¾
253⅝	287⅝	321⅝	354⅝	136	576½	75¾
257⅝	291⅝	325⅝	360⅝	138	585	77
261⅝	295⅝	330⅝	365⅝	140	593½	78
264⅝	300⅝	335⅝	370⅝	142	602	79
268⅝	304⅝	340⅝	375⅝	144	610½	80¼
272⅝	308⅝	344⅝	381⅝	146	619	81¼
276⅝	312⅝	349⅝	386⅝	148	627½	82½
279⅝	317⅝	354⅝	391⅝	150	636	83½

Ripplefold™ Stack Guide for Butt Master 84214xxx

Note: Stack size is estimated. Type of fabric used could alter these measurements. Please refer to the Ripplefold Fabrication Manual for more information.

120% Fullness	100% Fullness	80% Fullness	60% Fullness	Number of factory snaps	Snap Tape Length (less return length)*	Panel Stackback
14 ⁷ / ₈	16 ³ / ₈	17 ⁷ / ₈	19 ³ / ₈	8	32 ¹ / ₂	7 ¹ / ₂
18 ⁵ / ₈	20 ⁵ / ₈	22 ⁵ / ₈	24 ⁵ / ₈	10	41	8 ¹ / ₂
22 ³ / ₈	24 ⁷ / ₈	27 ³ / ₈	29 ⁷ / ₈	12	49 ¹ / ₂	9 ³ / ₄
26 ¹ / ₈	29 ¹ / ₈	32 ¹ / ₈	35 ¹ / ₈	14	58	10 ³ / ₄
29 ⁷ / ₈	33 ³ / ₈	36 ⁷ / ₈	40 ³ / ₈	16	66 ¹ / ₂	12
33 ⁵ / ₈	37 ⁵ / ₈	41 ⁵ / ₈	45 ⁵ / ₈	18	75	13
37 ³ / ₈	41 ⁷ / ₈	46 ³ / ₈	50 ⁷ / ₈	20	83 ¹ / ₂	14
41 ¹ / ₈	46 ¹ / ₈	51 ¹ / ₈	56 ¹ / ₈	22	92	15 ¹ / ₄
44 ⁷ / ₈	50 ³ / ₈	55 ⁷ / ₈	61 ³ / ₈	24	100 ¹ / ₂	16 ¹ / ₄
48 ⁵ / ₈	54 ⁵ / ₈	60 ⁵ / ₈	66 ⁵ / ₈	26	109	17 ¹ / ₂
52 ³ / ₈	58 ⁷ / ₈	65 ³ / ₈	71 ⁷ / ₈	28	117 ¹ / ₂	18 ¹ / ₂
56 ¹ / ₈	63 ¹ / ₈	70 ¹ / ₈	77 ¹ / ₈	30	126	19 ¹ / ₂
59 ⁷ / ₈	67 ³ / ₈	74 ⁷ / ₈	82 ³ / ₈	32	134 ¹ / ₂	20 ³ / ₄
63 ⁵ / ₈	71 ⁵ / ₈	79 ⁵ / ₈	87 ⁵ / ₈	34	143	21 ³ / ₄
67 ³ / ₈	75 ⁷ / ₈	84 ³ / ₈	92 ⁷ / ₈	36	151 ¹ / ₂	23
71 ¹ / ₈	80 ¹ / ₈	89 ¹ / ₈	98 ¹ / ₈	38	160	24
74 ⁷ / ₈	84 ³ / ₈	93 ⁷ / ₈	103 ³ / ₈	40	168 ¹ / ₂	25
78 ⁵ / ₈	88 ⁵ / ₈	98 ⁵ / ₈	108 ⁵ / ₈	42	177	26 ¹ / ₄
82 ³ / ₈	92 ⁷ / ₈	103 ³ / ₈	113 ⁷ / ₈	44	185 ¹ / ₂	27 ¹ / ₄
86 ¹ / ₈	97 ¹ / ₈	108 ¹ / ₈	119 ¹ / ₈	46	194	28 ¹ / ₂
89 ⁷ / ₈	101 ³ / ₈	112 ⁷ / ₈	124 ³ / ₈	48	202 ¹ / ₂	29 ¹ / ₂
93 ⁵ / ₈	105 ⁵ / ₈	117 ⁵ / ₈	129 ⁵ / ₈	50	211	30 ¹ / ₂
97 ³ / ₈	109 ⁷ / ₈	122 ³ / ₈	134 ⁷ / ₈	52	219 ¹ / ₂	31 ³ / ₄
101 ¹ / ₈	114 ¹ / ₈	127 ¹ / ₈	140 ¹ / ₈	54	228	32 ³ / ₄
104 ⁷ / ₈	118 ³ / ₈	131 ⁷ / ₈	145 ³ / ₈	56	236 ¹ / ₂	34
108 ⁵ / ₈	122 ⁵ / ₈	136 ⁵ / ₈	150 ⁵ / ₈	56	245	35
112 ³ / ₈	126 ⁷ / ₈	141 ³ / ₈	155 ⁷ / ₈	60	253 ¹ / ₂	36 ¹ / ₄
116 ¹ / ₈	131 ¹ / ₈	146 ¹ / ₈	161 ¹ / ₈	62	262	37 ¹ / ₄
119 ⁷ / ₈	135 ³ / ₈	150 ⁷ / ₈	166 ³ / ₈	64	270 ¹ / ₂	38 ¹ / ₄
123 ⁵ / ₈	139 ⁵ / ₈	155 ⁵ / ₈	171 ⁵ / ₈	66	279	39 ¹ / ₂
127 ³ / ₈	143 ⁷ / ₈	160 ³ / ₈	176 ⁷ / ₈	68	287 ¹ / ₂	40 ¹ / ₂
131 ¹ / ₈	148 ¹ / ₈	165 ¹ / ₈	182 ¹ / ₈	70	296	41 ³ / ₄
134 ⁷ / ₈	152 ³ / ₈	169 ⁷ / ₈	187 ³ / ₈	72	304 ¹ / ₂	42 ³ / ₄
138 ⁵ / ₈	156 ⁵ / ₈	174 ⁵ / ₈	192 ⁵ / ₈	74	313	43 ³ / ₄
142 ³ / ₈	160 ⁷ / ₈	179 ³ / ₈	197 ⁷ / ₈	76	321 ¹ / ₂	45
146 ¹ / ₈	165 ¹ / ₈	184 ¹ / ₈	203 ¹ / ₈	78	330	46

Ripplefold™ Stack Guide for Butt Master 84214xxx

Note: Stack size is estimated. Type of fabric used could alter these measurements. Please refer to the Ripplefold Fabrication Manual for more information.

120% Fullness	100% Fullness	80% Fullness	60% Fullness	Number of factory snaps	Snap Tape Length (less return length)*	Panel Stackback
149⅜	169⅜	188⅜	208⅜	80	338½	47¼
153⅜	173⅜	193⅜	213⅜	82	347	48¼
157⅜	177⅜	198⅜	218⅜	84	355½	49½
161⅜	182⅜	203⅜	224⅜	86	364	50½
164⅞	186⅜	207⅞	229⅞	88	372½	51½
168⅝	190⅝	212⅝	234⅝	90	381	52¾
172⅜	194⅞	217⅜	239⅞	92	389½	53¾
176⅜	199⅜	222⅜	245⅜	94	398	55
179⅞	203⅜	226⅞	250⅞	96	406½	56
183⅜	207⅜	231⅜	255⅜	98	415	57
187⅜	211⅞	236⅜	260⅞	100	423½	58¼
191⅜	216⅜	241⅜	266⅜	102	432	59¼
194⅞	220⅜	245⅞	271⅞	104	440½	60½
198⅝	224⅝	250⅝	276⅝	106	449	61½
202⅜	228⅞	255⅜	281⅞	108	457½	62½
206⅜	233⅜	260⅜	287⅜	110	466	63¾
209⅞	237⅜	264⅞	292⅞	112	474½	64¾
213⅝	241⅜	269⅝	297⅝	114	483	66
217⅜	245⅞	274⅞	302⅞	116	491½	67
221⅜	250⅜	279⅜	308⅜	118	500	68¼
224⅞	254⅜	283⅞	313⅞	120	508½	69¼
228⅝	258⅝	288⅝	318⅝	122	517	70¼
232⅜	262⅞	293⅜	323⅜	124	525½	71½
236⅜	267⅜	298⅜	329⅜	126	534	72½
239⅞	271⅜	302⅞	334⅞	128	542½	73¾
243⅝	275⅝	307⅝	339⅝	130	551	74¾
247⅜	279⅞	312⅜	344⅞	132	559½	75¾
251⅜	284⅜	317⅜	350⅜	134	568	77
254⅞	288⅜	321⅞	355⅞	136	576½	78
258⅝	292⅝	326⅝	360⅝	138	585	79¼
262⅜	296⅞	331⅜	365⅜	140	593½	80¼
266⅜	301⅜	336⅜	371⅜	142	602	81¼
269⅞	305⅜	340⅞	376⅞	144	610½	82½
273⅝	309⅝	345⅝	381⅝	146	619	83½
277⅜	313⅞	350⅞	386⅞	148	627½	84¾
281⅜	318⅜	355⅜	392⅜	150	636	85¾

Ripplefold™ Overlap Stack Guide

Note: Stack size is estimated. Type of fabric used could alter these measurements. Please refer to the Ripplefold Fabrication Manual for more information.

120% Fullness	100% Fullness	80% Fullness	60% Fullness	Number of factory snaps	Snap Tape Length (less return length)*	Panel Stackback
16¼	17¾	19⅞	20¾	8	34	9
20	22	23⅞	26	10	42½	10¼
23¾	26¼	28⅞	31¼	12	51	11¼
27½	20½	33⅞	26½	14	59½	12½
31¼	34¾	38⅞	41¾	16	68	13½
35	39	42⅞	47	18	76½	14½
38¾	43¼	47⅞	52¼	20	85	15¾
42½	47½	52⅞	57½	22	93½	16¾
46¼	51¾	57⅞	62¾	24	102	18
50	56	61⅞	68	26	110½	19
53¾	60¼	66⅞	73¼	28	119	20
57½	64½	71⅞	78½	30	127½	21¼
61¼	68¾	76⅞	83¾	32	136	22¼
65	73	80⅞	89	34	144½	23½
68¾	77¼	85⅞	94¼	36	153	24½
72½	81½	90⅞	99½	38	161½	25½
76¼	85¾	95⅞	104¾	40	170	26¾
80	90	99⅞	110	42	178½	27¾
83¾	94¼	104⅞	115¼	44	187	29
87½	98½	109⅞	120½	46	195½	30
91¼	102¾	114⅞	125¾	48	204	31
95	107	118⅞	131	50	212½	32¼
98¾	111¼	123⅞	136¼	52	221	33¼
102½	115½	128⅞	141½	54	229½	34½
106¼	119¾	133⅞	146¾	56	238	35½
110	124	137⅞	152	56	246½	36½
113¾	128¼	142⅞	157¼	60	255	37¾
117½	132½	147⅞	162½	62	263½	38¾
121¼	136¾	152⅞	167¾	64	272	40
125	141	156⅞	173	66	280½	41
128¾	145¼	161⅞	178¼	68	289	42
132½	149½	166⅞	183½	70	297½	43¼
136¼	153¾	171⅞	188¾	72	306	44¼
140	158	175⅞	194	74	314½	45½
143¾	162¼	180⅞	199¼	76	323	46½
147½	166½	185⅞	204½	78	331½	47½

Ripplefold™ Overlap Stack Guide

Note: Stack size is estimated. Type of fabric used could alter these measurements. Please refer to the Ripplefold Fabrication Manual for more information.

120% Fullness	100% Fullness	80% Fullness	60% Fullness	Number of factory snaps	Snap Tape Length (less return length)*	Panel Stackback
151¼	170¼	190½	209¾	80	340	48¾
155	175	194¾	215	82	348½	49¾
158¾	179¼	199½	220¼	84	357	51
162½	183½	204¾	225½	86	365½	52
166¼	187¾	209½	230¾	88	374	53
170	192	213¾	236	90	382½	54¼
173¾	196¼	218½	241¼	92	391	55¼
177½	200½	223¾	246½	94	399½	56½
181¼	204¾	228½	251¾	96	408	57½
185	209	232¾	257	98	416½	58½
188¾	213¼	237½	262¼	100	425	59¾
192½	217½	242¾	267½	102	433½	60¾
196¼	221¾	247½	272¾	104	442	62
200	226	251¾	278	106	450½	63
203¾	230¼	256½	283¼	108	459	64
207½	234½	261¾	288½	110	467½	65¼
211¼	238¾	266½	293¾	112	476	66¼
215	243	270¾	299	114	484½	67½
218¾	247¼	275½	304¼	116	493	68½
222½	251½	280¾	309½	118	501½	69½
226¼	255¾	285½	314¾	120	510	70¾
230	260	289¾	320	122	518½	71¾
233¾	264¼	294½	325¼	124	527	73
237½	268½	299¾	330½	126	535½	74
241¼	272¾	304½	335¾	128	544	75
245	277	308¾	341	130	552½	76¼
248¾	281¼	313½	346¼	132	561	77¼
252½	285½	318¾	351½	134	569½	78½
256¼	289¾	323½	356¾	136	578	79½
260	294	327¾	362	138	586½	80½
263¾	298¼	332½	367¼	140	595	81¾
267½	302½	337¾	372½	142	603½	82¾
271¼	306¾	342½	377¾	144	612	84
275	311	346¾	383	146	620½	85
278¾	315¼	351½	388¼	148	629	86
282½	319½	356¾	393½	150	637½	87¼

Pole Installation, Cutting & Splicing

Top Hole Installation Guide

This chart will position the bracket so the drapery will clear the floor approximately ½".

1. Find your pole style, size and header style in the chart.
2. Determine the desired finished drapery length.
3. Add or subtract number in the top hole column from the drapery's finished length to determine how high to measure for the top hole of the bracket.

Stationary Poles					
	Rod Pocket (no top ruffle)			Pleated (any variety)	
	Top Hole			Top Hole	Pin Set
1" Standard Bracket	+¾"			+2⅝"	¼"

Wall Mount Traverse Rods					
	Pleated (any variety)			Ripplefold™ (any fullness)	
	Top Hole for Wall Mount	Floor to Ceiling Deduction	Suggested Pin Set	Top Hole for Wall Mount	Floor to Ceiling Deduction
1⅜" Estate™	+1 ¹¹ / ₁₆ "	-2 ¹ / ₈ "	½"	+1 ¹¹ / ₁₆ "	-2 ¹ / ₈ "

Ceiling Mount Traverse Rods					
1⅜" Estate™	+0"	-3 ⁵ / ₈ "	½"	+0"	-3 ⁵ / ₈ "

Cutting & Splicing Wrought Iron Poles

- Measure to desired length and carefully wrap area with an easy peel, blue painter's tape as not to damage the finish.
- Cut through the tape with sharp fine tooth saw or a pipe cutter with a stainless steel blade. Cut slowly to reduce any chipping to the product finish.
- For spliced poles, add a finial plug to the end cut.
- Splice fits inside the pole and is specific to the pole diameter.



Finial Plug
Part #56369058
or #56469058



Splice
Part #56366061
or #56466061

Learn more about all of our collections

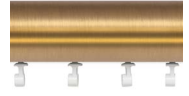

	Buckingham® Collection	Designer Metals™ Collection	Wood Trends™ Collection	Wrought Iron Collection	Estate™ Traverse Rods Collection
	exquisitely handcrafted distinguished style custom order	sophisticated styles acrylic and metals striking finishes	crafted timelessness beautiful finishes classic designs	architectural statement remarkable history real wrought iron	form meets function innovative solutions customizable
Available Diameters	1 3/8", 2", 3"	1 3/8" & 2"	1 3/8" & 2"	1" & 1 3/8"	1 3/8" Wrought Iron 1 3/8" & 2" Buckingham®, Designer Metals™ Wood Trends™ 2" Varia & Chroma
Pole Lengths	4', 6', 8', 12'	Fixed - 8' Telescoping - 36"-180"	4', 6', 8', 12'	6' & 8'	18"-16'
Pole Material	Wood	Metal	Wood	Metal	Wood, Metal, Varia & Chroma
Operation Modes	Stationary, Traversing Manual or Motorized Draw	Stationary, Traversing Manual or Motorized Draw	Stationary, Traversing Manual or Motorized Draw	Stationary, Traversing Manual or Motorized Draw	Traversing Manual or Motorized Draw
Pole Sizing	Fixed Width	Fixed Width & Telescoping	Fixed Width	Fixed Width	Cut to Measure
Finishes	15	8	9	6	62
Finials	48	24	18	18	108
Bracket Types	Decorative Fixed	Decorative Fixed & Bypass Fixed	Decorative Fixed	Decorative Fixed & Bypass Fixed	Concealed Adjustable
Bracket Sizes	3 1/2" – 6"	3" – 8 3/4", Inside Mount & Ceiling Mount	3 1/2" – 7", Inside Mount & Ceiling Mount	3 1/2" – 6 1/2" & Inside Mount	1 3/4" – 3 1/4"
Treatment Styles	Stationary & Traversing	Stationary & Traversing	Stationary & Traversing	Stationary & Traversing	Traversing



Designer Metals | Stratta in Brushed Bronze



Wrought Iron | Darby in Graphite, Golden Heirloom



Wood Trends | Chaucer in Estate Oak, Black



Buckingham | Aston in Camden

PRODUCT NO.	PAGE	PRODUCT NO.	PAGE	PRODUCT NO.	PAGE	PRODUCT NO.	PAGE
1026661	25	56374802	11	56376804	28	56460803	23
1833770	22	56375770	17	56376805	28	56460804	23
1833777	22	56375777	17	56381770	8	56460805	23
1833802	22	56375802	17	56381777	8	56461770	26
1833803	22	56351803	11	56381802	8	56461777	26
1833804	22	56351804	11	56381803	8	56461802	26
1833805	22	56351805	11	56381804	8	56461803	26
2989899000	25	56358803	12	56381805	8	56461804	26
2989901000	25	56358804	12	56382770	8	56461805	26
2989902000	25	56358805	12	56382777	8	56462770	27
56351770	11	56359803	13	56382802	8	56462777	27
56351777	11	56359804	13	56382803	8	56462802	27
56351802	11	56359805	13	56382804	8	56462803	27
56358770	12	56360803	13	56382805	8	56462804	27
56358777	12	56360804	13	56383770	8	56462805	27
56358802	12	56360805	13	56383777	8	56463770	27
56359770	13	56361803	14	56383802	8	56463777	27
56359777	13	56361804	14	56383803	8	56463802	27
56359802	13	56361805	14	56383804	8	56463803	27
56360770	13	56362803	15	56383805	8	56463804	27
56360777	13	56362804	15	56384770	8	56463805	27
56360802	13	56362805	15	56384777	8	56465770	27
56361770	14	56363803	15	56384802	8	56465777	27
56361777	14	56363804	15	56384803	8	56465802	27
56361802	14	56363805	15	56384804	8	56465803	27
56362770	15	56365803	15	56384805	8	56465804	27
56362777	15	56365804	15	56385770	11	56465805	27
56362802	15	56365805	15	56385777	11	56466061	28
56363770	15	56367803	16	56385802	11	56467770	28
56363777	15	56367804	16	56385803	11	56467777	28
56363802	15	56367805	16	56385804	11	56467802	28
56365770	15	56370803	16	56385805	11	56467803	28
56365777	15	56370804	16	56451770	20	56467804	28
56365802	15	56370805	16	56451777	20	56467805	28
56366061	17	56371803	14	56451802	20	56469058	28
56367770	16	56371804	14	56451803	20	56470770	28
56367777	16	56371805	14	56451804	20	56470777	28
56367802	16	56372803	15	56451805	20	56470802	28
56369058	17	56372804	15	56458770	22	56470803	28
56370770	16	56372805	15	56458777	22	56470804	28
56370777	16	56373803	11	56458802	22	56470805	28
56370802	16	56373804	11	56458803	22	56471770	26
56371770	14	56373805	11	56458804	22	56471777	26
56371777	14	56374803	11	56458805	22	56471802	26
56371802	14	56374804	11	56459770	23	56471803	26
56372770	15	56374805	11	56459777	23	56471804	26
56372777	15	56375803	17	56459802	23	56471805	26
56372802	15	56375804	17	56459803	23	56472770	27
56373770	11	56375805	17	56459804	23	56472777	27
56373777	11	56376770	28	56459805	23	56472802	27
56373802	11	56376777	28	56460770	23	56472803	27
56374770	11	56376802	28	56460777	23	56472804	27
56374777	11	56376803	28	56460802	23	56472805	27

PRODUCT NO.	PAGE	PRODUCT NO.	PAGE
56473770	20	83697770	24
56473777	20	83697777	24
56473802	20	83697802	24
56473803	20	83697803	24
56473804	20	83697804	24
56473805	20	83697805	24
56474770	20	83698770	24
56474777	20	83698777	24
56474802	20	83698802	24
56474803	20	83698803	24
56474804	20	83698804	24
56474805	20	83698805	24
56481770	19	84990000	29
56481777	19		
56481802	19		
56481803	19		
56481804	19		
56481805	19		
56482770	19		
56482777	19		
56482802	19		
56482803	19		
56482804	19		
56482805	19		
56483770	19		
56483777	19		
56483802	19		
56483803	19		
56483804	19		
56483805	19		
56484770	19		
56484777	19		
56484802	19		
56484803	19		
56484804	19		
56484805	19		
56485770	20		
56485777	20		
56485802	20		
56485803	20		
56485804	20		
56485805	20		
62102000	25		
62101010	25		
62101000	25		
62108000	25		
62109000	25		
62201300	25		
71134110	24		
71132006	24		
71132012	24		
71132062	24		
71132110	24		



Buckingham®
redefining luxury

Designer Metals™
inspiring brilliance

Wood Trends™
renewing traditions

Wrought Iron
forging artistry

**Custom Rodding
& Basic Hardware**
unique solutions