

// Retail Price List & Product Info Guide



ALTA
WINDOW FASHIONS
design simplified

ROLLER SHADES

Pricing effective July 22, 2024 and supersedes all previous pricing.
Subject to change by Alta Window Fashions.

Revised 9-3-24

[Table of Contents](#)

[Product Component Guide](#)

[General Info & Ordering](#)

[Dealer Sales Guide](#)

[Automation Price Guide](#)

[Installation & Programming](#)

[Color Swatches](#)

[Dealer Resource Center](#)

[Fabric Drops](#)

SUMMARY OF REVISIONS

9-3-24 RevisionsUpdated roll width info and added Greenguard info
New Spec Format for Continuous Loop Control and Automation
Updated Top Treatment legend - Cordless lift
Updated roll width info - Touchlift
Updated roll width info - Dual Mount
Updated tensioner color coordination of stainless steel - Continuous Loop Control

8-16-24 Revisions:

Page 70Update Labels under the Bottomrail Image

7-25-24 Revisions:

Pages 30Revised Fabric Name for AB018

TABLE OF CONTENTS

Product Overview

• Collection Information (includes Opacity)	2-5
• Color Chart.(Includes Phifer Binder Collections)	6-10
• Flame Retardant Fabric	11

Pricing Information

• Price Grids	12-17
– Fabric Collections	12-14
– Screen Collecctions.	15-16
• Surcharges	17
– Cordless Lift	
– Top Treatment	
– Tube Size Upgrade	
– Others: Privacy Light Block, Side/Sill Channels, Keystone, Valance Return Only, Custom Splicing/Seam Placement, Dual Mount and Extension Pole	

Spec Specifications

• Tube Size Upgrade	18
• Spec Grid: Continuous Loop Control and Automation	19-123
– Fabric Collections	19-63
– Deco Collections	64-123
• Fabric Spec Chart Navigation for Cordless Lift	124
• Spec Grid: Cordless Lift	125-144
• Spec Grid: Touchlift	145-150
• Spec Grid: Dual Mount	151-152

Product Specifications

• Operating Systems: Continuous Loop Control and Cordless	153-154
• Top Treatments: Cassettes, Fascia, Fabric Cornice (Keystone)	155-157
• Dual Mount	158
• Side & Bottom Channel	159
• Privacy Light Block, Spring Assist, Railroadng/Material Splicing/Seam Placement	160
• Bottomrail Options	161
• Additional Options: Roll Direction, 2 on 1, Hold Down Bracket, Spacer Block & Motor Ready	162
• Product Characteristics & Information	163-164
• Product Size Specifications – Additional Automation Information	165
• Mounting Requirement	166
• Finished Dimensions	167-181
• Solar Optical Chart and Information	182-193

Fabric Drops

Dealer Sales Guide – With our brand new Dealer Sales Guides, you can gain a comprehensive understanding of our products, including product characteristics and performance expectations. [Click here to explore.](#)

Automation Price Guide – Automation pricing is now featured in a separate guide for quick reference. [Click here to view.](#)

Product Components Guide – product components pages are now featured in a separate guide for quick reference. [Click here to view.](#)

SCREEN COLLECTION INFORMATION

Fabric Drops

Collection Code	Collection Name	Screen Collection Price Group	Roll Width	Composition	Opacity	Greenguard Certified	Railroad Option	Splice/Seam	Bottom Rail Omni Heat Sealed Aluminum	Panel Track
R80	1% E Screen	5	122"	36% Fiberglass, 64% Vinyl	1% Openness	Yes	Yes	Yes	All	Yes
AS010	1% EnduroScreen	4	98"	25% Fiberglass, 75% PVC	1% Openness	Yes	Yes	Yes	All	Yes
AS013	1% Environs Screen	4	118"	100% TPO -thermoplastic	1% Openness	Yes	Yes	No	Omni Only	Yes
RS23	1% Nordic Screen Plus	3	118"	70% PVC, 30% Polyester	1% Openness	Yes	Yes	Yes	All	Yes
RS7	1% S Screen	6	122"	33% Fiberglass 59.6% Vinyl, 6.8% Polyester	1% Openness	Yes	No	No	All	Yes
R01	1% Sheerweave 2500	6	126"	37% Fiberglass, 63% Vinyl on Fiberglass	1% Openness	Yes	Yes	Yes	All	Yes
RS21	1% Sheerweave 2701	6	126"	36% Fiberglass, 64% Vinyl on Fiberglass	1% Openness	Yes	Yes	Yes	All	Yes
P4001	1% Sheerweave 4001	6	126"	25% Polyester, 75% Vinyl on Polyester	1% Openness	Yes	Yes	Yes	All	Yes
P4901	1% Sheerweave 4901	5	98"	17% Polyester, 83% Vinyl on Polyester	1% Openness	Yes	Yes	Yes	All	Yes
P5001	1% Sheerweave 5000	5	98"	40% Polyester, 60% Vinyl on Polyester	1% Openness	Yes	Yes	Yes	All	Yes
AS028	3% Bamboo	6	113"	70% PVC, 30% Polyester	3% Openness	No	No	No	All	Yes
AS024	3% Bellflower	5	113"	70% PVC, 30% Polyester	3% Openness	No	No	No	All	Yes
AS026	3% Delhi	5	113"	70% PVC, 30% Polyester	3% Openness	No	No	No	All	Yes
R81	3% E Screen	5	122"	36% Fiberglass, 64% Vinyl	3% Openness	Yes	No	No	All	Yes
AS008	3% Ecoscape Screen	4	118"	18% Polyester, 25% Recycle Polyester, 57% PVC	3% Openness	Yes	No	No	All	Yes
AS011	3% EnduroScreen	4	98"	25% Fiberglass, 75% PVC	3% Openness	Yes	Yes	Yes	All	Yes
AS014	3% Environs Screen	4	118"	100% TPO -thermoplastic	3% Openness	Yes	Yes	No	Omni Only	Yes
AS027	3% Lady Amherst	6	113"	70% PVC, 30% Polyester	3% Openness	No	No	No	All	Yes
RS24	3% Nordic Screen Plus	2	118"	70% PVC, 30% Polyester	3% Openness	Yes	Yes	Yes	All	Yes
R06	3% Sheerweave 2410	5	126"	36% Fiberglass, 64% Vinyl on Fiberglass	3% Openness	Yes	Yes	Yes	All	Yes
P2703	3% Sheerweave 2703	5	126"	36% Fiberglass, 64% Vinyl on Fiberglass	3% Openness	Yes	Yes	Yes	All	Yes
RS2	3% Sheerweave 4400	5	126"	25% Polyester, 75% Vinyl on Polyester	3% Openness	Yes	Yes	Yes	All	Yes
P4600	3% Sheerweave 4600	5	98"	17% Polyester, 83% Vinyl on Polyester	3% Openness	Yes	Yes	Yes	All	Yes
P4903	3% Sheerweave 4903	5	98"	17% Polyester, 83% Vinyl on Polyester	3% Openness	Yes	Yes	Yes	All	Yes
R07	3% Sheerweave 5000	5	98"	49% Polyester, 51% Vinyl on Polyester	3% Openness	Yes	Yes	Yes	All	Yes
AS029	3% Sovereign	6	113"	70% PVC, 30% Polyester	3% Openness	No	No	No	All	Yes
AS006	3% Tweed Screen	3	118"	30% Polyester, 70%PVC	3% Openness	Yes	Yes	Yes	All	Yes
RS15	4% S Screen	6	122"	33.6% Fiberglass, 59.6% Vinyl, 6.8% Polyester	4% Openness	Yes	No	No	All	Yes
R51	5% E Screen	5	122"	36% Fiberglass, 64% Vinyl	5% Openness	Yes	Yes	Yes	All	Yes
AS009	5% Ecoscape Screen	3	118"	18% Polyester, 25% Recycle Polyester, 57% PVC	5% Openness	Yes	No	No	All	Yes
AS012	5% EnduroScreen	3	98"	25% Fiberglass, 75% PVC	5% Openness	Yes	Yes	Yes	All	Yes
AS015	5% Environs Screen	3	118"	18% Polyester, 25% Recycle Polyester, 57% PVC	5% Openness	Yes	Yes	No	Omni Only	Yes
R61	5% M Screen Deco	5	98"	36% Fiberglass, 64% Vinyl	5% Openness	Yes	Yes	Yes	All	Yes
RS25	5% Nordic Screen Plus	1	118"	70% PVC, 30% Polyester	5% Openness	Yes	Yes	Yes	All	Yes
P2000	5% Sheerweave 2000	5	126"	37% Fiberglass, 63% Vinyl on Fiberglass	5% Openness	Yes	Yes	Yes	All	Yes
RS1	5% Sheerweave 2390	5	126"	35% Fiberglass, 65% Vinyl on Fiberglass	5% Openness	Yes	Yes	Yes	All	Yes
P2705	5% Sheerweave 2705	5	98"	36% Fiberglass, 64% Vinyl on Fiberglass	5% Openness	Yes	Yes	Yes	All	Yes
R09	5% Sheerweave 4000	5	126"	25% Polyester, 75% Vinyl on Polyester	5% Openness	Yes	Yes	Yes	All	Yes
P4500	5% Sheerweave 4500	5	126"	17% Polyester, 83% Vinyl on Polyester	5% Openness	Yes	Yes	Yes	All	Yes
R10	5% Sheerweave 5000	5	98"	28% Polyester, 72% Vinyl on Polyester	5% Openness	Yes	Yes	Yes	All	Yes
AS007	5% Spectra Screen	3	118"	30% Polyester, 70%PVC	5% Openness	Yes	Yes	Yes	All	Yes
AS005	5% Willow Screen	3	118"	30% Polyester, 70%PVC	5% Openness	Yes	Yes	Yes	All	Yes
R34	7% Sheerweave 5000	5	98"	Varies	7% Openness	Yes	Yes	Yes	All	Yes
R19	10% E Screen	3	122"	36% Fiberglass, 64% Vinyl	10% Openness	Yes	Yes	Yes	All	Yes
P2360	10% Sheerweave 2360	5	126"	35% Fiberglass, 65% Vinyl on Fiberglass	10% Openness	Yes	Yes	Yes	All	Yes
P4100	10% Sheerweave 4100	3	98"	25% Polyester, 75% Vinyl on Polyester	10% Openness	Yes	Yes	Yes	All	Yes
R26	10% Sheerweave 5000	5	98"	28% Polyester, 72% Vinyl on Polyester	10% Openness	Yes	Yes	Yes	All	Yes

NOTE: Refer to the specification charts for the minimum and maximum width and height of each fabric under for specific system and/or top treatment .

FABRIC COLLECTION INFORMATION

Fabric Drops

Collection Code	Collection Name	Fabric Collection Price Group	Roll Width	Composition	Opacity	Greenguard Certified	Railroad Option	Splice/Seam	Bottom Rail Omni Heat Sealed Aluminum	Panel Track
AF034	Adelaide	6	118"	100% Polyester	Semi-Sheer	Yes	No	No	All	Yes
AB034	Adelaide Blackout	7	114"	100% Polyester	Blackout	Yes	No	No	All	Yes
AF016	Aegean	8	78 3/4"	100% Polyester	Light Filtering	No	No	No	All	Yes
AF030	Alpine	5	118"	100% Polyester	Light Filtering	No	Yes	Yes	All	Yes
AB030	Alpine Blackout	6	118"	100% Polyester	Blackout	No	Yes	Yes	All	Yes
AF020	Aqua-TEX	5	118"	50% PES/50% ReOcPlastic	Semi-Sheer	Yes	No	No	All	Yes
AB020	Aqua-TEX Blackout	6	114"	50% PES/50% ReOcPlastic	Blackout	Yes	No	No	All	Yes
AF035	Arches	3	118"	100% Polyester	Light Filtering	No	No	No	All	Yes
AB035	Arches Blackout	4	118"	100% Polyester	Blackout	No	No	No	All	Yes
AB022	Aries Blackout	8	118"	100% Polyester	Blackout	Yes	No	No	All	Yes
AF019	Baltic	2	110"	100% Polyester	Light Filtering	No	No	No	All	Yes
AB019	Baltic Blackout	3	110"	100% Polyester	Blackout	No	No	No	All	Yes
AF028	Bamboo	6	113"	100% Polyester	Light Filtering	No	No	No	All	Yes
AB028	Bamboo Blackout	7	113"	100% Polyester	Blackout	No	No	No	All	Yes
AF024	Bellflower	5	113"	100% Polyester	Light Filtering	No	No	No	All	Yes
AB024	Bellflower Blackout	6	113"	100% Polyester	Blackout	No	No	No	All	Yes
R40	Blackout - Solid	1	72"	73% PVC, 27% Woven Fiberglass	Vinyl	Yes	Yes	Yes	All	Yes
AF031	Bonn	6	98"	100% Polyester	Light Filtering	Yes	Yes	Yes	All	Yes
RD8	Brilliance	6	118"	100% Polyester	Semi-Sheer	Yes	No	No	All	Yes
RB6	Brilliance Blackout	6	118"	100% Polyester	Blackout	Yes	No	No	All	Yes
AF040	Burton	4	110"	93.3% Polyester 6.7% Linen	Light Filtering	Yes	No	No	All	No
RD6	Carrara	2	110"	100% Polyester with Acrylic Coating	Light Filtering	No	No	No	All	Yes
RB4	Carrara Blackout	2	110"	100% Polyester with Acrylic Coating	Blackout	No	No	No	All	No
RB16	Chesapeake Blackout	4	94"	100% Polyester	Blackout	No	No	Yes	All	Yes
RD7	Claudio	5	110"	90% Polyester, 10% Cationic Polyester	Semi-Sheer	Yes	No	No	All	Yes
RB5	Claudio Blackout	5	110"	90% Polyester, 10% Cationic Polyester	Blackout	Yes	No	No	All	Yes
AB021	Cusco Blackout	7	110"	100% Polyester	Blackout	No	No	No	All	Yes
AF026	Delhi	5	105"	100% Polyester	Light Filtering	No	No	No	All	Yes
AB026	Delhi Blackout	6	105"	100% Polyester	Blackout	No	No	No	All	Yes
RD2	Drizzle	5	94"	89% Polyester, 11% Linen	Light Filtering	No	Yes	Yes	All	Yes
AF037	Fuji	8	78 3/4"	100% Polyester	Light Filtering	No	Yes	Yes	All	No
AF025	Heritage	6	105"	100% Polyester	Light Filtering	No	No	No	All	Yes
AB025	Heritage Blackout	7	105"	100% Polyester	Blackout	No	No	No	All	Yes
AB036	Horizon Blackout	8	110"	100% Polyester	Blackout	No	No	No	All	Yes
AF018	Juniper	4	110"	100% Polyester	Light Filtering	No	Yes	Yes	All	Yes
AB018	Juniper Blackout	5	110"	100% Polyester	Blackout	No	Yes	Yes	All	Yes
AF027	Lady Amherst	6	113"	100% Polyester	Light Filtering	No	No	No	All	Yes
AB027	Lady Amherst Blackout	7	113"	100% Polyester	Blackout	No	No	No	All	Yes
AF033	Lavish	4	110"	100% Polyester	Light Filtering	No	No	No	All	Yes
R56	Linview	3	122"	100% Polyester	Light Filtering	No	Yes	Yes	All	Yes
RB3	Linview Blackout	4	120"	100% Polyester	Blackout	No	Yes	Yes	All	Yes
RF4	Montero	3	94"	100% Polyester with Acrylic Coating	Light Filtering	No	No	No	All	Yes

NOTE: Refer to the specification charts for the minimum and maximum width and height of each fabric under for specific system and/or top treatment .

FABRIC COLLECTION INFORMATION

Fabric Drops

Collection Code	Collection Name	Fabric Collection Price Group	Roll Width	Composition	Opacity	Greenguard Certified	Railroad Option	Splice/Seam	Bottom Rail Omni Heat Sealed Aluminum	Panel Track
AR041	Opulence Room Darkening	8	78 3/4"	100% Polyester	Room Darkening	No	No	No	All	Yes
AF032	Pacific	6	122"	100% Polyester	Light Filtering	No	No	No	All	Yes
AB032	Pacific Blackout	7	121"	100% Polyester	Blackout	No	No	No	All	Yes
AF017	Queenland	6	118"	100% Polyester	Semi-Sheer	Yes	No	No	All	Yes
AB017	Queenland Blackout	7	114"	100% Polyester	Blackout	Yes	No	No	All	Yes
RD21	Ranger	3	110"	100% Polyester	Light Filtering	Yes	No	No	All	Yes
RB13	Ranger Blackout	3	110"	100% Polyester	Blackout	Yes	No	No	All	Yes
AF038	Rhine	0	110"	100% Polyester	Light Filtering	Yes	No	No	All	Yes
RF3	Santa Cruz	3	94"	100% Polyester	Semi-Sheer	No	No	No	All	Yes
RB1	Santa Cruz Blackout	3	94"	100% Polyester	Blackout	No	No	No	All	Yes
R100	Scala Blackout	2	110"	100% Polyester	Blackout	Yes	Yes	Yes	All	Yes
AF039	Sequoia	4	110"	100% Polyester	Light Filtering	Yes	Yes	Yes	All	Yes
R11	Sheerweave 7000	8	118"	100% Polyester with Acrylic Foamed Backing	Blackout	Yes	Yes	Yes	All	Yes
P7200R	Sheerweave 7200R	4	118"	100% Polyester	Blackout	Yes	No	No	All	Yes
P7250R	Sheerweave 7250R	4	118"	100% Polyester	Semi-Sheer	Yes	No	No	All	Yes
P7400	Sheerweave 7400	7	118"	100% Polyester	Blackout	Yes	No	No	All	Yes
P7450	Sheerweave 7450	5	118"	100% Polyester	Semi-Sheer	Yes	No	No	All	Yes
P7500	Sheerweave 7500	3	118"	100% Polyester with Acrylic Coating	Blackout	Yes	Yes	Yes	Omni Only	Yes
P7500R	Sheerweave 7500R	3	118"	100% Polyester with Acrylic Coating	Blackout	Yes	Yes	Yes	Omni Only	Yes
P7700R	Sheerweave 7700R	4	118"	100% Polyester	Blackout	Yes	No	No	Omni Only	Yes
P7750R	Sheerweave 7750R	4	118"	100% Polyester	Semi-Sheer	Yes	No	No	All	Yes
RF35	Sorrento	3	108"	85.9% Polyester, 8.3% Cotton, 5.8% Flax	Semi-Sheer	Yes	No	No	All	Yes
AF042	Urban	6	118"	100% Polyester	Light Filtering	No	Yes	Yes	All	Yes
AR042	URBAN Room Darkening	7	118"	100% Polyester	Room Darkening	No	Yes	Yes	All	Yes
RD13	Vail	2	110"	100% Polyester	Light Filtering	Yes	No	No	All	Yes
RB19	Vail Blackout	2	110"	100% Polyester	Blackout	Yes	Yes	Yes	All	Yes
AF023	York	7	118"	100% Polyester	Light Filtering	No	No	No	All	Yes
AB004	Zen Blackout	8	78 3/4"	Polyester 100%	Blackout	No	No	No	All	Yes

NOTE: Refer to the specification charts for the minimum and maximum width and height of each fabric under for specific system and/or top treatment.

Cut yardage is available. Please contact customer service for pricing.

- Must purchase roll width
- Minimum height: One Linear Yard
- Maximum height: Ten Linear Yards
- Full yard increments only (i.e. 1/2 yards not available)

COLLECTION INFORMATION

Defining Opacity <i>(Light blockage varies by color, fabric style and mounting type. Side light gaps are inherent in roller shade products.)</i>			
Opacity Classification	Light Control/Privacy	View Through Fabric	Best Use
Semi Sheer	Most Light/Least Privacy Diffuses light	Objects are visible	A room that requires minimal light control and privacy like a kitchen or play room.
Light Filtering	Moderate Light/Some Privacy Blocks some light	Objects less visible	A room that requires moderate light control and privacy like a dining room or family room.
Room Darkening	Least Light/Most privacy Blocks most light	Objects are not visible	A room where light control and privacy is required, like a bedroom or media room.
Blackout	Most Privacy with No Light Gap Blocks most light	Objects are not visible	A room that requires maximum privacy and light control with no side light gaps.

****Opacity (LF & BO) Crossover Reference**

- Adelaide & Adelaide Blackout
- Alpine & Alpine Blackout
- Aqua-Tex & Aqua-Tex Blackout
- Arches & Arches Blackout
- Baltic & Baltic Blackout
- Bamboo & Bamboo Blackout
- Bellflower & Bellflower Blackout
- Brilliance & Brilliance Blackout
- Claudio & Claudio Blackout
- Delhi & Delhi Blackout
- Heritage & Heritage Blackout
- Juniper & Juniper Blackout
- Lady Amherst & Lady Amherst Blackout
- Linview & Linview Blackout
- Pacific & Pacific Blackout
- Queensland & Queensland Blackout
- Ranger & Ranger Blackout
- Santa Cruz & Santa Cruz Blackout
- Sheerweave 7250R (LF) & 7200R (BO)
- Sheerweave 7450 (LF) & 7400 (BO)
- Sheerweave 7500 (LF) & 7500R (BO)
- Sheerweave 7750R (LF) & 7700R (BO)
- Urban & Urban Room Darkening
- Vail & Vail Blackout

Roller/Banded Crossover Reference

- Burton LF & Burton LF
- Lavish LF & RD & Lavish LF

Openness Crossover Reference: (Most colors cross over)

- E Screen (1%, 3%, 5%, & 10%)
- 3% Ecoscape Screen, 5% Ecoscape Screen
- 1% Environs Screen, 3% Environs Screen, 5% Environs Screen
- 1% EnduroScreen, 3% EnduroScreen, 5% EnduroScreen
- Nordic Screen Plus (1%, 3%, & 5%), all colors cross over
- S Screen (1% & 4%)
- Sheerweave (SW)
 - 1% SW2500, 3% SW2410, & 5% SW2390 & 10% SW2360
 - 1% SW2701, 3% SW2703 & 5% SW2705
 - 1% SW4001, 3% SW4400, 5% SW4000, 10% SW4100
 - 3% SW4600 & 5% SW4500
 - 1% SW4901 & 3% SW4903
 - 1% SW5000, 3% SW5000, 5% SW5000, 7% SW5000, 10% SW5000

Some collections will not have complementary opacity and openness for each color. For collections that have, there may be a hue variation.

SCREEN COLOR CHART

Fabric Drops

Collection Code	Collection Name	Color Code	Screen Color	Component Set	Open Roll Bracket Color
R80	1% E Screen	09	Charcoal/Charcoal	Black	Black
R80	1% E Screen	07	Charcoal/Cocoa	Bronze	Black
R80	1% E Screen	08	Charcoal/Grey	Black	Black
R80	1% E Screen	05	White/Linen	Vanilla	White
R80	1% E Screen	03	White/Pearl	Black	White
R80	1% E Screen	04	White/White	White	White
AS010	1% EnduroScreen	05	Black/Black	Black	Black
AS010	1% EnduroScreen	04	Black/Bronze	Bronze	Black
AS010	1% EnduroScreen	06	Black/Grey	Black	Black
AS010	1% EnduroScreen	02	White/Beige	Vanilla	White
AS010	1% EnduroScreen	03	White/Grey	Gray/Silver	White
AS010	1% EnduroScreen	01	White/White	White	White
AS013	1% Environs Screen	05	Black/Black	Black	Black
AS013	1% Environs Screen	04	Black/Bronze	Bronze	Black
AS013	1% Environs Screen	06	Black/Grey	Black	Black
AS013	1% Environs Screen	02	White/Beige	Vanilla	White
AS013	1% Environs Screen	03	White/Grey	Gray/Silver	White
AS013	1% Environs Screen	01	White/White	White	White
RS23	1% Nordic Screen Plus	04	Black/ Copper	Bronze	Black
RS23	1% Nordic Screen Plus	03	Black/Black	Black	Black
RS23	1% Nordic Screen Plus	01	Bright White	White	White
RS23	1% Nordic Screen Plus	06	White Gray	Gray/Silver	White
RS23	1% Nordic Screen Plus	05	White Linen	Vanilla	White
RS7	1% S Screen	03	Granite	Gray/Silver	White
RS7	1% S Screen	04	Papyrus	Vanilla	White
RS7	1% S Screen	02	Porcelain	White	White
R01	1% Sheerweave 2500	P84	Brite White	White	White
R01	1% Sheerweave 2500	03	Charcoal	Black	Black
R01	1% Sheerweave 2500	09	Charcoal/Alpaca	Black	Black
R01	1% Sheerweave 2500	06	Oyster/Beige	White	White
R01	1% Sheerweave 2500	07	Oyster/Pearl Gray	Gray/Silver	White
RS21	1% Sheerweave 2701	01	Oyster	White	White
RS21	1% Sheerweave 2701	02	Oyster/Beige	Vanilla	White
RS21	1% Sheerweave 2701	06	Oyster/Charcoal	Black	Black
RS21	1% Sheerweave 2701	03	Oyster/Pearl Gray	Gray/Silver	White
RS21	1% Sheerweave 2701	04	Oyster/Pewter	Gray/Silver	White
P5001	1% Sheerweave 5000	V17	Jute/Fog	Gray/Silver	White
R19	10% E Screen	02	Charcoal/Charcoal	Black	Black
R19	10% E Screen	08	White Pearl	White	White
R19	10% E Screen	06	White/White	White	White
AS028	3% Bamboo	02	Sand	Vanilla	White
AS028	3% Bamboo	03	Sea Grass	White	White
AS024	3% Bellflower	03	Deep Ocean	Black	Black
AS024	3% Bellflower	02	Light Taupe	Vanilla	White
AS024	3% Bellflower	04	Waterstone	Black	Black
AS026	3% Delhi	02	Royal Navy	Gray/Silver	White
AS026	3% Delhi	01	Westport Gray	Gray/Silver	White
R81	3% E Screen	02	Charcoal/Charcoal	Black	Black
R81	3% E Screen	07	Charcoal/Cocoa	Bronze	Black
R81	3% E Screen	08	Charcoal/Grey	Black	Black
R81	3% E Screen	04	White/Linen	Vanilla	White
R81	3% E Screen	05	White/Pearl	White	White
R81	3% E Screen	06	White/White	White	White
AS008	3% Ecoscape Screen	04	Black	Black	Black
AS008	3% Ecoscape Screen	05	Black/Grey	Black	Black
AS008	3% Ecoscape Screen	03	Grey	Gray/Silver	White
AS008	3% Ecoscape Screen	02	Linen	Vanilla	White
AS008	3% Ecoscape Screen	01	White	White	White
AS011	3% EnduroScreen	05	Black/Black	Black	Black
AS011	3% EnduroScreen	04	Black/Bronze	Bronze	Black
AS011	3% EnduroScreen	06	Black/Grey	Black	Black
AS011	3% EnduroScreen	02	White/Beige	Vanilla	White
AS011	3% EnduroScreen	03	White/Grey	Gray/Silver	White
AS011	3% EnduroScreen	01	White/White	White	White
AS014	3% Environs Screen	05	Black/Black	Black	Black
AS014	3% Environs Screen	04	Black/Bronze	Bronze	Black
AS014	3% Environs Screen	06	Black/Grey	Black	Black
AS014	3% Environs Screen	02	White/Beige	Vanilla	White
AS014	3% Environs Screen	03	White/Grey	Gray/Silver	White
AS014	3% Environs Screen	01	White/White	White	White

Collection Code	Collection Name	Color Code	Screen Color	Component Set	Open Roll Bracket Color
AS027	3% Lady Amherst	02	Amore Pink	White	White
AS027	3% Lady Amherst	05	Fair Haven	Vanilla	White
AS027	3% Lady Amherst	06	Seabrook	Gray/Silver	White
AS027	3% Lady Amherst	03	Silver	Gray/Silver	White
AS027	3% Lady Amherst	04	Soft Sky	Gray/Silver	White
RS24	3% Nordic Screen Plus	04	Black/ Copper	Bronze	Black
RS24	3% Nordic Screen Plus	03	Black/Black	Black	Black
RS24	3% Nordic Screen Plus	01	Bright White	White	White
RS24	3% Nordic Screen Plus	06	White Gray	Gray/Silver	White
RS24	3% Nordic Screen Plus	05	White Linen	Vanilla	White
R06	3% Sheerweave 2410	P84	Brite White	White	White
R06	3% Sheerweave 2410	03	Charcoal	Black	Black
R06	3% Sheerweave 2410	09	Charcoal/Alpaca	Black	Black
R06	3% Sheerweave 2410	06	Oyster/Beige	White	White
R06	3% Sheerweave 2410	07	Oyster/Pearl Gray	Gray/Silver	White
P2703	3% Sheerweave 2703	P12	Oyster	White	White
P2703	3% Sheerweave 2703	P13	Oyster/Beige	Vanilla	White
P2703	3% Sheerweave 2703	P28	Oyster/Charcoal	Black	Black
P2703	3% Sheerweave 2703	P14	Oyster/Pearl Gray	Gray/Silver	White
P2703	3% Sheerweave 2703	P91	Oyster/Pewter	Gray/Silver	White
R07	3% Sheerweave 5000	04	Linen/Cream	Vanilla	White
AS029	3% Sovereign	02	Evening	Gray/Silver	White
AS029	3% Sovereign	01	Sepia	Vanilla	White
AS029	3% Sovereign	03	Stonewall	Gray/Silver	White
AS006	3% Tweed Screen	04	Almond	White	White
AS006	3% Tweed Screen	01	Bronze	Bronze	Black
AS006	3% Tweed Screen	03	Buttercream	Vanilla	White
AS006	3% Tweed Screen	02	Gray	Gray/Silver	White
RS15	4% S Screen	004	Granite	Bronze	Black
RS15	4% S Screen	003	Papyrus	Gray/Silver	White
RS15	4% S Screen	001	Porcelain	White	White
R51	5% E Screen	05	Charcoal/Charcoal	Black	Black
R51	5% E Screen	04	Charcoal/Cocoa	Bronze	Black
R51	5% E Screen	10	Charcoal/Grey	Black	Black
R51	5% E Screen	08	White/Linen	Vanilla	White
R51	5% E Screen	09	White/Pearl	White	White
R51	5% E Screen	01	White/White	White	White
AS009	5% Ecoscape Screen	04	Black	Black	Black
AS009	5% Ecoscape Screen	05	Black/Grey	Black	Black
AS009	5% Ecoscape Screen	03	Grey	Gray/Silver	White
AS009	5% Ecoscape Screen	02	Linen	Vanilla	White
AS009	5% Ecoscape Screen	01	White	White	White
AS012	5% EnduroScreen	05	Black/Black	Black	Black
AS012	5% EnduroScreen	04	Black/Bronze	Bronze	Black
AS012	5% EnduroScreen	06	Black/Grey	Black	Black
AS012	5% EnduroScreen	02	White/Beige	Vanilla	White
AS012	5% EnduroScreen	03	White/Grey	Gray/Silver	White
AS012	5% EnduroScreen	01	White/White	White	White
AS015	5% Environs Screen	05	Black/Black	Black	Black
AS015	5% Environs Screen	04	Black/Bronze	Bronze	Black
AS015	5% Environs Screen	06	Black/Grey	Black	Black
AS015	5% Environs Screen	02	White/Beige	Vanilla	White
AS015	5% Environs Screen	03	White/Grey	Gray/Silver	White
AS015	5% Environs Screen	01	White/White	White	White
R61	5% M Screen Deco	06	Parchment	White	White
R61	5% M Screen Deco	02	River Rock	Gray/Silver	White
R61	5% M Screen Deco	03	Tumbleweed	Bronze	Black
RS25	5% Nordic Screen Plus	04	Black/ Copper	Bronze	Black
RS25	5% Nordic Screen Plus	03	Black/Black	Black	Black
RS25	5% Nordic Screen Plus	01	Bright White	White	White
RS25	5% Nordic Screen Plus	06	White Gray	Gray/Silver	White
RS25	5% Nordic Screen Plus	05	White Linen	Vanilla	White
RS1	5% Sheerweave 2390	P84	Brite White	White	White
RS1	5% Sheerweave 2390	105	Charcoal	Black	Black
RS1	5% Sheerweave 2390	101	Oyster/Beige	White	White
RS1	5% Sheerweave 2390	103	Oyster/Pearl Gray	Gray/Silver	White
R10	5% Sheerweave 5000	14	Linen/Pearl	Vanilla	White
R10	5% Sheerweave 5000	15	Linen/Taupe	Gray/Silver	White

Component Set includes plastic chain, chain tensioner, top treatments with end caps, open roll bracket covers, and bottom rail with end caps.

Override request to change to metal chain or change color of the top treatment or bottom rail must be specified at the time of order.

Changing the color of the tensioner, any end caps and open roll bracket cover are not an available options.

DECORATIVE COLOR CHART

Fabric Drops

Collection Code	Collection Name	Color Code	Screen Color	Component Set	Open Roll Bracket Color
AS007	5% Spectra Screen	02	Amazon	Gray/Silver	White
AS007	5% Spectra Screen	01	Apple Green	Gray/Silver	White
AS007	5% Spectra Screen	10	Caramel	Vanilla	White
AS007	5% Spectra Screen	03	Cookie	Gray/Silver	White
AS007	5% Spectra Screen	05	Coral	White	White
AS007	5% Spectra Screen	09	Maroon	Black	Black
AS007	5% Spectra Screen	07	Mocha	Black	Black
AS007	5% Spectra Screen	06	Olive	Gray/Silver	White
AS007	5% Spectra Screen	04	Pistachio	Gray/Silver	White
AS007	5% Spectra Screen	08	Tan	Gray/Silver	White
AS005	5% Willow Screen	04	Barley	White	White
AS005	5% Willow Screen	02	Cappuccino	Gray/Silver	White
AS005	5% Willow Screen	01	Dark Chocolate	Bronze	Black
AS005	5% Willow Screen	07	Deep Brown	Black	Black
AS005	5% Willow Screen	03	Nobel Brown	Gray/Silver	White
AS005	5% Willow Screen	05	Oyster	Gray/Silver	White
AS005	5% Willow Screen	06	Parchment	Vanilla	White

Collection Code	Collection Name	Color Code	Fabric Color	Component Set	Open Roll Bracket Color
AF034	Adelaide	02	Cream	Vanilla	White
AF034	Adelaide	04	Mink	Black	Black
AF034	Adelaide	01	Parchment	White	White
AF034	Adelaide	03	Silver	Gray/Silver	White
AB034	Adelaide Blackout	02	Cream	Vanilla	White
AB034	Adelaide Blackout	04	Mink	White	White
AB034	Adelaide Blackout	01	Parchment	White	White
AB034	Adelaide Blackout	03	Silver	Gray/Silver	White
AF016	Aegean	01	Camel	Vanilla	White
AF016	Aegean	04	Galaxy	Black	Black
AF016	Aegean	02	Light Gray	Gray/Silver	White
AF016	Aegean	03	Pacific	Gray/Silver	White
AF030	Alpine	03	Caraway	Gray/Silver	White
AF030	Alpine	02	Driftwood	Bronze	White
AF030	Alpine	04	Peppercom	Gray/Silver	White
AF030	Alpine	01	Sesame	White	White
AB030	Alpine Blackout	03	Caraway	Gray/Silver	White
AB030	Alpine Blackout	02	Driftwood	Bronze	White
AB030	Alpine Blackout	04	Peppercom	Gray/Silver	White
AB030	Alpine Blackout	01	Sesame	White	White
AF020	Aqua-Tex	06	Black	Black	Black
AF020	Aqua-Tex	05	Kiwi	Gray/Silver	White
AF020	Aqua-Tex	03	Linen	Vanilla	White
AF020	Aqua-Tex	04	Periwinkle	Gray/Silver	White
AF020	Aqua-Tex	02	Silver	Gray/Silver	White
AF020	Aqua-Tex	01	Snowflake	White	White
AB020	Aqua-Tex Blackout	06	Black	Black	Black
AB020	Aqua-Tex Blackout	03	Linen	Vanilla	White
AB020	Aqua-Tex Blackout	02	Silver	Gray/Silver	White
AB020	Aqua-Tex Blackout	01	Snowflake	White	White
AF035	Arches	01	Pearl	White	White
AF035	Arches	02	Sesame	Vanilla	White
AF035	Arches	04	Shadow	Black	Black
AF035	Arches	03	Taupe	Bronze	Black
AB035	Arches Blackout	01	Pearl	White	White
AB035	Arches Blackout	02	Sesame	Vanilla	White
AB035	Arches Blackout	04	Shadow	Black	Black
AB035	Arches Blackout	03	Taupe	Bronze	Black
AB022	Aries Blackout	03	Daybreak	Vanilla	White
AB022	Aries Blackout	01	Linen	White	White
AB022	Aries Blackout	02	Silver	Gray/Silver	White
AF019	Baltic	03	Cadet Blue	Gray/Silver	White
AF019	Baltic	02	Carbon	Black	Black
AF019	Baltic	04	Citron	Gray/Silver	White
AF019	Baltic	01	Pale Taupe	Vanilla	White
AB019	Baltic Blackout	03	Cadet Blue	Gray/Silver	White
AB019	Baltic Blackout	02	Carbon	Black	Black
AB019	Baltic Blackout	04	Citron	Gray/Silver	White
AB019	Baltic Blackout	01	Pale Taupe	Vanilla	White
AF028	Bamboo	01	Chalk	White	White
AF028	Bamboo	02	Sand	Vanilla	White
AF028	Bamboo	03	Sea Grass	White	White
AB028	Bamboo Blackout	03	Sea Grass	White	White
AB028	Bamboo Blackout	02	Sand	Vanilla	White

Collection Code	Collection Name	Color Code	Fabric Color	Component Set	Open Roll Bracket Color
AF024	Bellflower	03	Deep Ocean	Black	Black
AF024	Bellflower	01	Frost	White	White
AF024	Bellflower	02	Light Taupe	Vanilla	White
AF024	Bellflower	04	Waterstone	Black	Black
AB024	Bellflower Blackout	03	Deep Ocean	Black	Black
AB024	Bellflower Blackout	02	Light Taupe	Vanilla	White
AB024	Bellflower Blackout	04	Waterstone	Black	Black
R40	Blackout - Solid	11	Alabaster	White	White
R40	Blackout - Solid	05	Bone	White	White
R40	Blackout - Solid	01	White	White	White
AF031	Bonn	04	French Blue	Gray/Silver	White
AF031	Bonn	03	Heather	Gray/Silver	White
AF031	Bonn	05	Rosewood	Bronze	Black
AF031	Bonn	01	Soft Linen	White	White
AF031	Bonn	02	Tan	Gray/Silver	White
RD8	Brilliance	11	Charcoal	Black	Black
RD8	Brilliance	07	Chiffon	White	White
RD8	Brilliance	10	Copper	Bronze	Black
RD8	Brilliance	09	Dolphin	Gray/Silver	White
RD8	Brilliance	08	Limestone	White	White
RB6	Brilliance Blackout	11	Charcoal	Black	Black
RB6	Brilliance Blackout	07	Chiffon	White	White
RB6	Brilliance Blackout	10	Copper	Bronze	Black
RB6	Brilliance Blackout	09	Dolphin	Gray/Silver	White
RB6	Brilliance Blackout	08	Limestone	White	White
AF040	Burton	03	Cloud	Gray/Silver	White
AF040	Burton	02	Ivory	Vanilla	White
AF040	Burton	01	Opal	White	White
RD6	Carrara	06	Coal	Black	Black
RD6	Carrara	08	Dove Gray	Gray/Silver	White
RD6	Carrara	07	Shea	White	White
RD6	Carrara	03	Silver	Gray/Silver	White
RD6	Carrara	05	Storm	Gray/Silver	White
RD6	Carrara	02	Tusk	Bronze	Black
RD6	Carrara	01	White	White	White
RB4	Carrara Blackout	06	Coal	Black	Black
RB4	Carrara Blackout	08	Dove Gray	Gray/Silver	White
RB4	Carrara Blackout	07	Shea	White	White
RB4	Carrara Blackout	03	Silver	Gray/Silver	White
RB4	Carrara Blackout	05	Storm	Gray/Silver	White
RB4	Carrara Blackout	02	Tusk	Bronze	Black
RB4	Carrara Blackout	01	White	White	White
RB16	Chesapeake Blackout	03	Coastal	Gray/Silver	White
RB16	Chesapeake Blackout	01	Seashell	White	White
RD7	Claudio	10	Cotton	White	White
RD7	Claudio	11	Ivory	White	White
RD7	Claudio	12	Marble	Black	Black
RB5	Claudio Blackout	10	Cotton	White	White
RB5	Claudio Blackout	11	Ivory	White	White
RB5	Claudio Blackout	12	Marble	Black	Black
AB021	Cusco Blackout	01	Beige	Vanilla	White
AB021	Cusco Blackout	03	Espresso	Black	Black
AB021	Cusco Blackout	02	Warm Tan	Bronze	Black
AF026	Delhi	02	Royal Navy	Gray/Silver	White
AF026	Delhi	01	Westport Gray	Gray/Silver	White
AB026	Delhi Blackout	02	Royal Navy	Gray/Silver	White
AB026	Delhi Blackout	01	Westport Gray	Gray/Silver	White
RD2	Drizzle	01	Flax	White	White
RD2	Drizzle	05	Graphite	Bronze	Black
RD2	Drizzle	04	Iron	Gray/Silver	White
RD2	Drizzle	06	Moonstone	White	White
AF037	Fuji	01	Pale Gold	White	White
AF025	Heritage	02	Mountain Sage	Gray/Silver	White
AF025	Heritage	01	Old Khaki	Bronze	Black
AB025	Heritage Blackout	02	Mountain Sage	Gray/Silver	White
AB025	Heritage Blackout	01	Old Khaki	Bronze	Black
AB036	Horizon Blackout	01	Crystal	White	White
AB036	Horizon Blackout	02	Granite	Gray/Silver	White
AB036	Horizon Blackout	03	Moss	Gray/Silver	White

Component Set includes plastic chain, chain tensioner, top treatments with end caps, open roll bracket covers, and bottom rail with end caps.

Override request to change to metal chain or change color of the top treatment or bottom rail must be specified at the time of order.

Changing the color of the tensioner, any end caps and open roll bracket cover are not an available options.

DECORATIVE COLOR CHART

Fabric Drops

Collection Code	Collection Name	Color Code	Fabric Color	Component Set	Open Roll Bracket Color
AF018	Juniper	02	Barley	Vanilla	White
AF018	Juniper	04	Pacific Wash	Gray/Silver	White
AF018	Juniper	03	Walnut	Bronze	Black
AB018	Juniper Blackout	02	Barley	Vanilla	White
AB018	Juniper Blackout	04	Pacific Wash	Gray/Silver	White
AB018	Juniper Blackout	03	Walnut	Bronze	Black
AF027	Lady Amherst	01	Alabaster	White	White
AF027	Lady Amherst	02	Amore Pink	White	White
AF027	Lady Amherst	05	Fair Haven	Vanilla	White
AF027	Lady Amherst	06	Seabrook	Gray/Silver	White
AF027	Lady Amherst	03	Silver	Gray/Silver	White
AF027	Lady Amherst	04	Soft Sky	Gray/Silver	White
AB027	Lady Amherst Blackout	02	Amore Pink	White	White
AB027	Lady Amherst Blackout	05	Fair Haven	Vanilla	White
AB027	Lady Amherst Blackout	06	Seabrook	Gray/Silver	White
AB027	Lady Amherst Blackout	03	Silver	Gray/Silver	White
AB027	Lady Amherst Blackout	04	Soft Sky	Gray/Silver	White
AF033	Lavish	02	Autumn Sky	Gray/Silver	White
AF033	Lavish	04	Shadow White	Vanilla	White
AF033	Lavish	01	Silverlake	Gray/Silver	White
AF033	Lavish	03	Snowfall	White	White
R56	Linview	13	Ash	Gray/Silver	White
R56	Linview	03	Cabana Wood	Gray/Silver	White
R56	Linview	11	Fog	Gray/Silver	White
R56	Linview	06	Macadamia	Vanilla	White
R56	Linview	15	Midnight Black	Black	Black
R56	Linview	02	Morning Light	White	White
R56	Linview	10	Navy	Gray/Silver	White
R56	Linview	14	New York Grey	Black	Black
R56	Linview	09	Pale Lapis	Gray/Silver	White
R56	Linview	17	Pale Oak	White	White
R56	Linview	12	Porpoise	Gray/Silver	White
R56	Linview	16	Sea Smoke	White	White
R56	Linview	05	Slate	Gray/Silver	White
R56	Linview	18	Soft Linen	Vanilla	White
R56	Linview	01	Summer White	White	White
R56	Linview	04	Weathered Walnut	Bronze	Black
RB3	Linview Blackout	02	Alabaster	White	White
RB3	Linview Blackout	03	Café Crème	Vanilla	White
RB3	Linview Blackout	06	Colonnade Gray	Gray/Silver	White
RB3	Linview Blackout	09	Gauntlet Gray	Gray/Silver	White
RB3	Linview Blackout	07	Pale Gray	Gray/Silver	White
RB3	Linview Blackout	11	Pale Oak	White	White
RB3	Linview Blackout	01	Pure White	White	White
RB3	Linview Blackout	10	Sea Smoke	White	White
RB3	Linview Blackout	12	Soft Linen	Vanilla	White
RB3	Linview Blackout	04	Stone	Gray/Silver	White
RB3	Linview Blackout	05	Tranquility	Bronze	Black
RB3	Linview Blackout	08	Whale	Gray/Silver	White
RF4	Montero	201	Java Coast	Bronze	Black
RF4	Montero	202	Wicker Basket	Vanilla	White
AR041	Opulence Room Darkening	02	Champagne	Vanilla	White
AR041	Opulence Room Darkening	01	Umber	Bronze	Black
AF032	Pacific	01	Alabaster	White	White
AF032	Pacific	02	Golden Oak	Vanilla	White
AF032	Pacific	03	Gray Marble	Gray/Silver	White
AF032	Pacific	04	Metallic Gray	Gray/Silver	White
AB032	Pacific Blackout	01	Alabaster	White	White
AB032	Pacific Blackout	02	Golden Oak	Vanilla	White
AB032	Pacific Blackout	03	Gray Marble	Gray/Silver	White
AB032	Pacific Blackout	04	Metallic Gray	Gray/Silver	White
AF017	Queenland	02	Bone	Vanilla	White
AF017	Queenland	04	Buff	Gray/Silver	White
AF017	Queenland	03	Dove Grey	Gray/Silver	White
AF017	Queenland	01	Snow	White	White
AB017	Queenland Blackout	02	Bone	Vanilla	White
AB017	Queenland Blackout	04	Buff	Gray/Silver	White
AB017	Queenland Blackout	03	Dove Grey	Gray/Silver	White
AB017	Queenland Blackout	01	Snow	White	White

Collection Code	Collection Name	Color Code	Fabric Color	Component Set	Open Roll Bracket Color
RD21	Ranger	06	Charcoal	Black	Black
RD21	Ranger	01	Chiffon	Vanilla	White
RD21	Ranger	02	Pewter	Gray/Silver	White
RD21	Ranger	05	White	White	White
RB13	Ranger Blackout	06	Charcoal	Black	Black
RB13	Ranger Blackout	01	Chiffon	Vanilla	White
RB13	Ranger Blackout	02	Pewter	Gray/Silver	White
RB13	Ranger Blackout	05	White	White	White
AF038	Rhine	04	Black Pearl	Black	Black
AF038	Rhine	03	Chamomile	Gray/Silver	White
AF038	Rhine	02	Ivory	White	White
AF038	Rhine	01	White	White	White
RF3	Santa Cruz	101	Bunglehouse Blue	Gray/Silver	White
RF3	Santa Cruz	100	Manchester	Gray/Silver	White
RF3	Santa Cruz	106	Night Sky	Bronze	Black
RF3	Santa Cruz	107	Rainforest	Bronze	Black
RB1	Santa Cruz Blackout	02	Bunglehouse Blue	Gray/Silver	White
RB1	Santa Cruz Blackout	01	Manchester	Gray/Silver	White
RB1	Santa Cruz Blackout	04	Night Sky	Bronze	Black
RB1	Santa Cruz Blackout	03	Rainforest	Bronze	Black
R100	Scala Blackout	04	Silver	Gray/Silver	White
R100	Scala Blackout	01	White	White	White
AF039	Sequoia	01	Lace	White	White
AF039	Sequoia	03	Mist	Gray/Silver	White
AF039	Sequoia	02	Vanilla	White	White
P7200R	Sheerweave 7200R	RB2	Oyster	White	White
P7200R	Sheerweave 7200R	RB1	Swan	White	White
P7250R	Sheerweave 7250R	RL2	Oyster	White	White
P7250R	Sheerweave 7250R	RL1	Swan	White	White
P7400	Sheerweave 7400	U80	Cotton	White	White
P7400	Sheerweave 7400	U81	Parchment	Vanilla	White
P7400	Sheerweave 7400	U83	Pebble	Gray/Silver	White
P7450	Sheerweave 7450	U80	Cotton	White	White
P7450	Sheerweave 7450	U81	Parchment	Vanilla	White
P7450	Sheerweave 7450	U83	Pebble	Gray/Silver	White
P7700R	Sheerweave 7700R	TB1	Crystal	White	White
P7700R	Sheerweave 7700R	TB2	Sand	Vanilla	White
P7750R	Sheerweave 7750R	TL3	Concrete	Gray/Silver	White
P7750R	Sheerweave 7750R	TL1	Crystal	White	White
P7750R	Sheerweave 7750R	TL2	Sand	Vanilla	White
RF35	Sorrento	002	Bisque	Vanilla	White
RF35	Sorrento	001	Linen	White	White
AF042	Urban	02	Cool Gray	Gray/Silver	White
AF042	Urban	03	Latte	Vanilla	White
AF042	Urban	01	Soft White	White	White
AR042	Urban Room Darkening	02	Cool Gray	Gray/Silver	White
AR042	Urban Room Darkening	03	Latte	Vanilla	White
AR042	Urban Room Darkening	01	Soft White	White	White
RD13	Vail	01	Grey	Gray/Silver	White
RD13	Vail	02	Hazel	Vanilla	White
RD13	Vail	03	Sage	White	White
RD13	Vail	04	White	White	White
RB19	Vail Blackout	01	Grey	Gray/Silver	White
RB19	Vail Blackout	02	Hazel	Vanilla	White
RB19	Vail Blackout	03	Sage	White	White
RB19	Vail Blackout	04	White	White	White
AF023	York	01	Almond	White	White
AF023	York	04	Aluminum	Gray/Silver	White
AF023	York	02	Dark Forest	Black	Black
AF023	York	03	Parchment	White	White
AB004	ZEN Blackout	02	Caramel	Gray/Silver	White
AB004	ZEN Blackout	03	Iron	Black	Black
AB004	ZEN Blackout	01	Pastel Gray	Gray/Silver	White

Component Set includes plastic chain, chain tensioner, top treatments with end caps, open roll bracket covers, and bottom rail with end caps.

Override request to change to metal chain or change color of the top treatment or bottom rail must be specified at the time of order.

Changing the color of the tensioner, any end caps and open roll bracket cover are not an available options.

COLOR CHART

(Phifer Binder Collections)

Fabric Drops

Screen					
Collection Code	Collection Name	Color Code	Color Name	Component Set	Open Roll Bracket Color
R09	5% Sheerweave 4000	01	Eco/Alabaster	White	White
R09	5% Sheerweave 4000	U64	Eco/Ash	Black	Black
R09	5% Sheerweave 4000	02	Eco/Chalk	White	White
R09	5% Sheerweave 4000	U65	Eco/Ebony	Black	Black
R09	5% Sheerweave 4000	06	Eco/Granite	Gray/Silver	White
R09	5% Sheerweave 4000	04	Eco/Greystone	Gray/Silver	White
R09	5% Sheerweave 4000	U60	Eco/Pebblestone	Vanilla	White
R09	5% Sheerweave 4000	U63	Eco/Pewter	Gray/Silver	Black
R09	5% Sheerweave 4000	U66	Eco/Tobacco	Bronze	Black
P4500	5% Sheerweave 4500	V95	Cappuccino	Bronze	Black
P4500	5% Sheerweave 4500	P06	Chalk	White	White
P4500	5% Sheerweave 4500	V96	Dark Bronze	Bronze	Black
P4500	5% Sheerweave 4500	V10	Ebony	Black	Black
P4500	5% Sheerweave 4500	Q59	Ecru	Vanilla	White
P4500	5% Sheerweave 4500	Q60	Golden Sand	Vanilla	White
P4500	5% Sheerweave 4500	P10	Granite	Gray/Silver	White
P4500	5% Sheerweave 4500	U32	Linen	Vanilla	White
P4500	5% Sheerweave 4500	V07	Pewter	Gray/Silver	White
P4500	5% Sheerweave 4500	V44	Sandstone	Gray/Silver	White
R10	5% Sheerweave 5000	09	Bark/Ash	Gray/Silver	White
R10	5% Sheerweave 5000	10	Bark/Pewter	Gray/Silver	White
R10	5% Sheerweave 5000	01	Bark/Tiger Oak	Bronze	Black
R10	5% Sheerweave 5000	07	Chenille/Driftwood	Bronze	Black
R10	5% Sheerweave 5000	Q43	Marble/Sand	Vanilla	White
R10	5% Sheerweave 5000	19	Metro /Platinum	Gray/Silver	White
R10	5% Sheerweave 5000	06	Tweed Oatmeal	Vanilla	White
R10	5% Sheerweave 5000	03	Tweed/Buckeye	Bronze	Black
R34	7% Sheerweave 5000	Q46	Bamboo/Wheat	Bronze	Black
R34	7% Sheerweave 5000	08	Linen/Clay	Gray/Silver	White

Light Filtering					
Collection Code	Collection Name	Color Code	Color Name	Component Set	Open Roll Bracket Color
P7250R	Sheerweave 7250R	RL7	Blazer	Gray/Silver	Black
P7250R	Sheerweave 7250R	RL4	Chiffon	Gray/Silver	White
P7250R	Sheerweave 7250R	RL5	Chrome	Gray/Silver	White
P7250R	Sheerweave 7250R	RL6	Earl Grey	Gray/Silver	White
P7250R	Sheerweave 7250R	RL8	Raven	Black	Black
P7250R	Sheerweave 7250R	RL3	Sail	Gray/Silver	White
P7450	Sheerweave 7450	U87	Flint	Black	Black
P7450	Sheerweave 7450	U84	Seagrass	Gray/Silver	Black
P7450	Sheerweave 7450	U82	Sesame	Vanilla	White
P7450	Sheerweave 7450	U85	Shale	Gray/Silver	Black
P7450	Sheerweave 7450	U86	Spice	Black	Black
P7750R	Sheerweave 7750R	TL4	Chalk	Gray/Silver	White
P7750R	Sheerweave 7750R	TL5	Graphite	Gray/Silver	White
P7750R	Sheerweave 7750R	TL7	Onyx	Black	Black
P7750R	Sheerweave 7750R	TL6	Pewter	Black	Black

Component Set includes plastic chain, chain tensioner, top treatments with end caps, open roll bracket covers, and bottom rail with end caps.

Override request to change to metal chain or change color of the top treatment or bottom rail must be specified at the time of order.

Changing the color of the tensioner, any end caps and open roll bracket cover are not an available options.

Blackout					
Collection Code	Collection Name	Color Code	Color Name	Component Set	Open Roll Bracket Color
R11	Sheerweave 7000	01	Birch	Vanilla	White
R11	Sheerweave 7000	U67	Canvas	Vanilla	White
R11	Sheerweave 7000	V41	Canyon	Gray/Silver	White
R11	Sheerweave 7000	U69	Cocoa	Bronze	Black
R11	Sheerweave 7000	07	Graphite	Gray/Silver	Black
R11	Sheerweave 7000	Q00	Merino	White	White
R11	Sheerweave 7000	02	Mushroom	Gray/Silver	White
R11	Sheerweave 7000	03	Onyx	Black	Black
R11	Sheerweave 7000	V70	Porpoise	Gray/Silver	White
R11	Sheerweave 7000	04	Sand	White	White
R11	Sheerweave 7000	Q57	Wheat	Vanilla	White
R11	Sheerweave 7000	06	White	White	White
P7200R	Sheerweave 7200R	RB7	Blazer	Gray/Silver	Black
P7200R	Sheerweave 7200R	RB4	Chiffon	Gray/Silver	White
P7200R	Sheerweave 7200R	RB5	Chrome	Gray/Silver	White
P7200R	Sheerweave 7200R	RB6	Earl Grey	Gray/Silver	White
P7200R	Sheerweave 7200R	RB8	Raven	Black	Black
P7200R	Sheerweave 7200R	RB3	Sail	Gray/Silver	White
P7400	Sheerweave 7400	U87	Flint	Black	Black
P7400	Sheerweave 7400	U84	Seagrass	Gray/Silver	Black
P7400	Sheerweave 7400	U82	Sesame	Vanilla	White
P7400	Sheerweave 7400	U85	Shale	Gray/Silver	Black
P7400	Sheerweave 7400	U86	Spice	Black	Black
P7500	Sheerweave 7500	R39	Cloud	White	White
P7500	Sheerweave 7500	R17	Dune	Vanilla	White
P7500	Sheerweave 7500	R13	Ice	White	White
P7500	Sheerweave 7500	R41	Limestone	Gray/Silver	White
P7500	Sheerweave 7500	R22	Midnight	Black	Black
P7500	Sheerweave 7500	R99	MidnightX2	Black	Black
P7500	Sheerweave 7500	R97	Mist	Gray/Silver	White
P7500	Sheerweave 7500	R42	Nimbus	Gray/Silver	White
P7500	Sheerweave 7500	R20	Odyssey	Gray/Silver	Black
P7500	Sheerweave 7500	S97	OrientX2	Black	Black
P7500	Sheerweave 7500	R21	Orient	Black	Black
P7500	Sheerweave 7500	R40	Porcelain	White	White
P7500	Sheerweave 7500	R19	Stone	Bronze	Black
P7500	Sheerweave 7500	R43	Tundra	Gray/Silver	White
P7500R	Sheerweave 7500R	R45	Cloud	White	White
P7500R	Sheerweave 7500R	R51	Dune	Vanilla	White
P7500R	Sheerweave 7500R	R44	Ice	White	White
P7500R	Sheerweave 7500R	R47	Limestone	Gray/Silver	White
P7500R	Sheerweave 7500R	R55	Midnight	Black	Black
P7500R	Sheerweave 7500R	R48	Mist	Gray/Silver	White
P7500R	Sheerweave 7500R	R49	Nimbus	Gray/Silver	White
P7500R	Sheerweave 7500R	R53	Odyssey	Gray/Silver	Black
P7500R	Sheerweave 7500R	R54	Orient	Black	Black
P7500R	Sheerweave 7500R	R46	Porcelain	White	White
P7500R	Sheerweave 7500R	R52	Stone	Bronze	Black
P7500R	Sheerweave 7500R	R50	Tundra	Gray/Silver	White
P7700R	Sheerweave 7700R	TB4	Chalk	Gray/Silver	White
P7700R	Sheerweave 7700R	TB3	Concrete	Gray/Silver	White
P7700R	Sheerweave 7700R	TB5	Graphite	Gray/Silver	White
P7700R	Sheerweave 7700R	TB7	Onyx	Black	Black
P7700R	Sheerweave 7700R	TB6	Pewter	Black	Black

FLAME-RETARDANT FABRICS

Collection Name	CCC-C-521E	NFPA #101 and/or #701	FTM 191A #5903
1% E Screen		X	
1% Nordic Screen Plus		X	
1% S Screen		X	
1% Sheerweave 2500		X	
1% Sheerweave 2701		X	
1% Sheerweave 4901		X	
1% Sheerweave 5000		X	
1% Sheerweave 4001		X	
3% E Screen		X	
3% Tweed Screen		X	
3% M Screen		X	
3% Nordic Screen Plus		X	
3% Sheerweave 2410		X	
3% Sheerweave 2703		X	
3% Sheerweave 4400		X	
3% Sheerweave 4600		X	
3% Sheerweave 4903		X	
3% Sheerweave 5000		X	
4% S Screen		X	
5% E Screen		X	

Collection Name	CCC-C-521E	NFPA #101 and/or #701	FTM 191A #5903
5% M Screen Deco		X	
5% Nordic Screen Plus		X	
5% Sheerweave 2000		X	
5% Sheerweave 2390		X	
5% Sheerweave 2705		X	
5% Sheerweave 4000		X	
5% Sheerweave 4500		X	
5% Sheerweave 5000		X	
5% Willow Screen		X	
5% Spectra Screen		X	
7% Sheerweave 5000		X	
10% E Screen		X	
10% Sheerweave 2360		X	
10% Sheerweave 4100		X	
10% Sheerweave 5000		X	
Blackout - Solid	X	X	X
Sheerweave 7400		X	
Sheerweave 7500		X	
Sheerweave 7000		X	

PRICE GROUPS – FABRIC COLLECTIONS

Fabric Drops

GROUP 0

WIDTH

LIGHT FILTERING: • Rhine - 110"														
GROUP 0	24"	30"	36"	48"	60"	72"	84"	96"	108"	120"	132"	144"	156"	168"
HEIGHT 36"	\$197	206	214	228	258	291	340	382	414	451	486	522	574	632
48"	203	214	221	240	276	336	391	440	481	518	554	591	650	716
60"	218	221	224	270	320	384	443	496	534	569	604	640	704	775
72"	234	252	258	309	374	427	486	537	577	623	667	712	784	862
84"	252	278	280	340	410	463	534	577	626	675	721	769	845	930
96"	265	290	307	370	443	493	571	623	675	726	778	831	913	1006
108"	284	312	329	399	471	528	609	667	721	778	834	890	980	1079
120"	305	334	352	429	500	559	646	709	771	831	889	948	1044	1148
132"	322	347	367	451	528	591	685	751	817	884	950	1018	1120	1232
144"	342	370	385	471	556	625	721	795	864	936	1008	1081	1189	1309

GROUP 1

WIDTH

VINYL: • Blackout Solid - 72"														
GROUP 1	24"	30"	36"	48"	60"	72"	84"	96"	108"	120"	132"	144"	156"	168"
HEIGHT 36"	\$209	219	227	242	274	310	362	406	440	480	517	555	611	673
48"	216	227	235	255	293	358	416	468	511	551	590	629	692	762
60"	232	235	238	287	341	409	471	527	568	606	643	681	749	824
72"	249	268	274	329	398	454	517	571	614	663	710	757	834	917
84"	268	296	298	362	436	492	568	614	666	718	767	818	899	989
96"	281	309	327	394	471	524	608	663	718	772	827	883	971	1070
108"	303	332	350	424	501	561	648	710	767	827	888	947	1042	1147
120"	325	356	375	456	532	595	687	754	820	883	946	1009	1110	1222
132"	343	369	391	480	561	629	729	799	869	941	1011	1083	1192	1311
144"	364	394	410	501	592	665	767	845	920	996	1072	1150	1265	1392

GROUP 2

WIDTH

LIGHT FILTERING: • Baltic - 110" • Carrara - 110" • Vail - 110"														
BLACKOUT: • Carrara Blackout - 110" • Scala Blackout - 110" • Vail Blackout - 110"														
GROUP 2	24"	30"	36"	48"	60"	72"	84"	96"	108"	120"	132"	144"	156"	168"
HEIGHT 36"	\$227	235	238	274	310	356	417	491	532	571	617	656	722	795
48"	242	247	250	298	341	396	466	547	599	648	700	741	816	897
60"	264	262	268	317	371	437	511	612	661	718	780	835	920	1011
72"	285	290	294	370	439	480	565	669	734	798	857	927	1020	1122
84"	307	313	321	402	473	522	614	723	799	872	942	1020	1122	1234
96"	326	332	341	434	509	567	664	787	861	943	1016	1104	1215	1338
108"	345	355	362	464	547	606	708	839	924	1024	1107	1189	1307	1439
120"	365	371	382	493	586	644	759	898	998	1097	1186	1283	1412	1553
132"	383	392	402	522	621	686	805	958	1063	1159	1265	1366	1504	1654
144"	406	416	423	550	650	729	850	1011	1127	1235	1349	1442	1587	1747

BLISS Automation pricing. [Click here to view.](#)
 Somfy Automation pricing. [Click here to view.](#)
 PowerWand pricing. [Click here to view.](#)

PRICE GROUPS – FABRIC COLLECTIONS

Fabric Drops

GROUP 3

WIDTH

LIGHT FILTERING: • Arches - 118" • Linview - 122" • Montero - 94" • Ranger - 110" • Santa Cruz - 94" • Sorrento - 108"														
BLACKOUT: • Baltic Blackout - 110" • Ranger Blackout - 110" • Santa Cruz Blackout - 94" • Sheerweave 7500 - 118" • Sheerweave 7500R - 118"														
GROUP 3	24"	30"	36"	48"	60"	72"	84"	96"	108"	120"	132"	144"	156"	168"
36"	\$236	242	261	302	331	396	461	546	592	645	689	738	811	892
48"	261	268	278	315	367	445	524	617	675	729	792	851	936	1030
60"	276	285	289	346	402	496	580	691	757	830	890	963	1059	1165
72"	325	331	337	422	500	547	645	763	839	913	996	1076	1185	1303
84"	341	349	358	462	547	605	704	834	924	1009	1094	1186	1304	1436
96"	369	381	387	493	589	656	759	909	1002	1099	1198	1288	1419	1561
108"	392	402	411	530	634	708	834	976	1081	1187	1300	1408	1549	1704
120"	418	429	437	565	682	759	882	1062	1165	1284	1408	1506	1657	1823
132"	440	455	464	599	723	815	953	1133	1246	1376	1506	1619	1781	1959
144"	466	475	489	640	773	868	1011	1206	1330	1464	1596	1718	1890	2079

HEIGHT

GROUP 4

WIDTH

LIGHT FILTERING: • Burton - 110" • Juniper - 110" • Lavish - 110" • Sequoia - 110" • Sheerweave 7250R - 118" • Sheerweave 7750R - 118"														
BLACKOUT: • Arches Blackout - 118" • Chesapeake Blackout - 94" • Linview Blackout - 120" • Sheerweave 7200R - 118" • Sheerweave 7700R - 118"														
GROUP 4	24"	30"	36"	48"	60"	72"	84"	96"	108"	120"	132"	144"	156"	168"
36"	\$245	268	274	297	348	409	476	551	602	656	699	747	822	905
48"	270	276	302	332	387	464	547	630	691	742	809	917	1009	1110
60"	298	307	324	355	409	520	609	711	777	851	916	987	1086	1196
72"	325	331	363	436	522	579	680	787	860	947	1026	1117	1228	1351
84"	349	361	392	482	575	639	746	863	953	1042	1146	1233	1357	1493
96"	369	384	422	516	623	696	807	944	1049	1160	1242	1353	1488	1637
108"	398	416	456	559	673	754	889	1017	1146	1254	1380	1475	1622	1786
120"	421	444	485	596	724	810	956	1100	1233	1340	1475	1594	1753	1928
132"	436	467	515	639	771	869	1030	1177	1324	1452	1586	1716	1886	2076
144"	474	492	541	680	823	929	1094	1257	1401	1541	1704	1841	2025	2228

HEIGHT

GROUP 5

WIDTH

LIGHT FILTERING: • Alpine - 118" • Aqua-Tex - 118" • Bellflower - 113" • Claudio - 110" • Delhi - 105" • Drizzle - 94" • Sheerweave 7450 - 118"														
BLACKOUT: • Claudio Blackout - 110" • Juniper Blackout - 110"														
GROUP 5	24"	30"	36"	48"	60"	72"	84"	96"	108"	120"	132"	144"	156"	168"
36"	\$269	278	286	326	374	423	494	562	615	671	726	773	874	987
48"	298	307	315	345	421	476	564	651	710	780	845	905	1021	1124
60"	324	333	337	384	464	540	635	733	801	885	962	1030	1100	1210
72"	362	370	380	446	540	598	712	818	897	987	1071	1156	1239	1362
84"	369	404	411	489	594	664	784	903	993	1086	1195	1278	1362	1498
96"	380	437	447	535	646	727	858	983	1092	1206	1301	1416	1527	1681
108"	409	468	480	572	699	790	929	1065	1194	1309	1421	1541	1658	1825
120"	436	501	515	615	752	848	1004	1159	1284	1408	1540	1653	1770	1946
132"	466	536	549	664	808	913	1086	1244	1377	1515	1641	1783	1924	2118
144"	493	568	583	706	861	978	1146	1323	1481	1615	1765	1906	2049	2254

HEIGHT

BLISS Automation pricing. [Click here to view.](#)

Somfy Automation pricing. [Click here to view.](#)

PowerWand pricing. [Click here to view.](#)

PRICE GROUPS – FABRIC COLLECTIONS

Fabric Drops

GROUP 6

WIDTH

LIGHT FILTERING: • Adelaide - 118" • Bamboo - 113" • Bonn - 98" • Brilliance - 118" • Heritage - 105" • Lady Amherst - 113" • Pacific - 122" • Queensland - 118" • Urban - 118"														
BLACKOUT: • Alpine Blackout - 118" • Aqua-Tex Blackout - 114" • Bellflower Blackout - 113" • Brilliance Blackout - 118" • Delhi Blackout - 105"														
GROUP 6	24"	30"	36"	48"	60"	72"	84"	96"	108"	120"	132"	144"	156"	168"
HEIGHT														
36"	\$276	289	303	345	381	444	534	615	674	735	798	856	942	1036
48"	307	313	333	383	437	522	617	712	797	863	940	1011	1112	1225
60"	334	343	368	423	490	594	700	822	909	988	1073	1163	1280	1408
72"	353	401	410	489	593	671	787	926	1029	1117	1214	1316	1447	1594
84"	392	409	455	542	660	740	877	1033	1124	1242	1366	1469	1617	1778
96"	424	445	494	589	722	817	963	1123	1254	1386	1496	1622	1786	1964
108"	463	482	524	643	791	888	1047	1225	1371	1506	1635	1764	1940	2134
120"	491	504	559	700	856	976	1133	1334	1486	1635	1786	1920	2113	2326
132"	527	540	599	746	915	1040	1222	1437	1581	1759	1925	2092	2301	2533
144"	558	572	634	804	968	1115	1315	1537	1718	1890	2067	2251	2476	2724

GROUP 7

WIDTH

LIGHT FILTERING: • York - 118"														
ROOM DARKENING: • Urban Room Darkening - 118"														
BLACKOUT: • Adelaide Blackout - 114" • Bamboo Blackout - 113" • Cusco Blackout - 110" • Heritage Blackout - 105" • Lady Amherst Blackout - 113" • Pacific Blackout - 121" • Queensland Blackout - 114" • Sheerweave 7400 - 118"														
GROUP 7	24"	30"	36"	48"	60"	72"	84"	96"	108"	120"	132"	144"	156"	168"
HEIGHT														
36"	\$317	338	359	412	481	567	671	773	850	927	1006	1081	1190	1309
48"	368	380	401	473	547	663	785	901	1002	1091	1189	1282	1410	1551
60"	391	433	457	534	624	761	889	1041	1148	1257	1365	1476	1624	1788
72"	457	468	519	623	758	857	1005	1171	1302	1421	1545	1675	1843	2027
84"	508	520	573	689	841	945	1119	1307	1433	1581	1739	1875	2062	2269
96"	551	567	626	754	926	1045	1231	1427	1595	1764	1904	2069	2275	2503
108"	596	612	673	821	1011	1136	1338	1561	1746	1920	2084	2251	2477	2725
120"	641	655	721	893	1097	1248	1456	1699	1892	2084	2279	2451	2697	2967
132"	687	701	775	960	1175	1330	1567	1830	2019	2243	2460	2669	2936	3230
144"	729	747	822	1027	1248	1430	1683	1960	2192	2412	2639	2875	3162	3479

GROUP 8

WIDTH

LIGHT FILTERING: • Aegean - 78 3/4" • Fuji - 78 3/4"														
ROOM DARKENING: • Opulence Room Darkening - 78 3/4"														
BLACKOUT: • Aries Blackout - 118" • Horizon Blackout - 110" • Sheerweave 7000 - 118" • Zen Blackout - 78 3/4"														
GROUP 8	24"	30"	36"	48"	60"	72"	84"	96"	108"	120"	132"	144"	156"	168"
HEIGHT														
36"	\$377	390	445	541	632	764	911	1058	1160	1263	1366	1468	1616	1777
48"	434	448	515	611	735	891	1062	1224	1363	1477	1611	1737	1911	2102
60"	494	510	585	695	840	1020	1197	1415	1561	1699	1845	1996	2197	2416
72"	580	602	686	838	1017	1155	1356	1590	1764	1919	2092	2261	2488	2737
84"	641	656	758	927	1133	1269	1503	1772	1935	2135	2348	2526	2779	3058
96"	701	718	827	1010	1242	1402	1655	1931	2151	2382	2572	2789	3069	3378
108"	754	774	892	1100	1356	1522	1798	2105	2357	2590	2807	3031	3335	3668
120"	807	823	951	1200	1466	1673	1948	2291	2552	2807	3070	3301	3630	3995
132"	867	887	1022	1284	1568	1782	2099	2467	2719	3025	3314	3595	3955	4351
144"	920	943	1086	1377	1666	1913	2256	2644	2953	3248	3557	3871	4259	4685

BLISS Automation pricing. [Click here to view.](#)
 Somfy Automation pricing. [Click here to view.](#)
 PowerWand pricing. [Click here to view.](#)

PRICE GROUPS – SCREEN COLLECTIONS

Fabric Drops

GROUP 1

WIDTH

SCREEN: • 5% Nordic Screen Plus - 118"														
GROUP 1	24"	30"	36"	48"	60"	72"	84"	96"	108"	120"	132"	144"	156"	168"
HEIGHT 36"	\$209	219	227	242	274	310	362	406	440	480	517	555	611	673
48"	216	227	235	255	293	358	416	468	511	551	590	629	692	762
60"	232	235	238	287	341	409	471	527	568	606	643	681	749	824
72"	249	268	274	329	398	454	517	571	614	663	710	757	834	917
84"	268	296	298	362	436	492	568	614	666	718	767	818	899	989
96"	281	309	327	394	471	524	608	663	718	772	827	883	971	1070
108"	303	332	350	424	501	561	648	710	767	827	888	947	1042	1147
120"	325	356	375	456	532	595	687	754	820	883	946	1009	1110	1222
132"	343	369	391	480	561	629	729	799	869	941	1011	1083	1192	1311
144"	364	394	410	501	592	665	767	845	920	996	1072	1150	1265	1392

GROUP 2

WIDTH

SCREEN: • 3% Nordic Screen Plus - 118"														
GROUP 2	24"	30"	36"	48"	60"	72"	84"	96"	108"	120"	132"	144"	156"	168"
HEIGHT 36"	\$227	235	238	274	310	356	417	491	532	571	617	656	722	795
48"	242	247	250	298	341	396	466	547	599	648	700	741	816	897
60"	264	262	268	317	371	437	511	612	661	718	780	835	920	1011
72"	285	290	294	370	439	480	565	669	734	798	857	927	1020	1122
84"	307	313	321	402	473	522	614	723	799	872	942	1020	1122	1234
96"	326	332	341	434	509	567	664	787	861	943	1016	1104	1215	1338
108"	345	355	362	464	547	606	708	839	924	1024	1107	1189	1307	1439
120"	365	371	382	493	586	644	759	898	998	1097	1186	1283	1412	1553
132"	383	392	402	522	621	686	805	958	1063	1159	1265	1366	1504	1654
144"	406	416	423	550	650	729	850	1011	1127	1235	1349	1442	1587	1747

GROUP 3

WIDTH

SCREEN: • 1% Nordic Screen Plus - 118" • 3% Tweed Screen - 118" • 5% Ecoscape Screen - 118" • 5% EnduroScreen - 98" • 5% Environs Screen - 118" • 5% Spectra Screen - 118" • 5% Willow Screen - 118" • 10% E Screen - 122" • 10% Sheerweave 4100 - 98"														
GROUP 3	24"	30"	36"	48"	60"	72"	84"	96"	108"	120"	132"	144"	156"	168"
HEIGHT 36"	\$236	242	261	302	331	396	461	546	592	645	689	738	811	892
48"	261	268	278	315	367	445	524	617	675	729	792	851	936	1030
60"	276	285	289	346	402	496	580	691	757	830	890	963	1059	1165
72"	325	331	337	422	500	547	645	763	839	913	996	1076	1185	1303
84"	341	349	358	462	547	605	704	834	924	1009	1094	1186	1304	1436
96"	369	381	387	493	589	656	759	909	1002	1099	1198	1288	1419	1561
108"	392	402	411	530	634	708	834	976	1081	1187	1300	1408	1549	1704
120"	418	429	437	565	682	759	882	1062	1165	1284	1408	1506	1657	1823
132"	440	455	464	599	723	815	953	1133	1246	1376	1506	1619	1781	1959
144"	466	475	489	640	773	868	1011	1206	1330	1464	1596	1718	1890	2079

BLISS Automation pricing. [Click here to view.](#)
 Somfy Automation pricing. [Click here to view.](#)
 PowerWand pricing. [Click here to view.](#)

PRICE GROUPS – SCREEN COLLECTIONS

Fabric Drops

GROUP 4

WIDTH

SCREEN: • 1% Enduro Screen - 98" • 1% Environs Screen - 118" • 3% Ecoscape Screen - 118" • 3% EnduroScreen - 98" • 3% Environs Screen - 118"

GROUP 4	24"	30"	36"	48"	60"	72"	84"	96"	108"	120"	132"	144"	156"	168"
36"	\$245	268	274	297	348	409	476	551	602	656	699	747	822	905
48"	270	276	302	332	387	464	547	630	691	742	809	917	1009	1110
60"	298	307	324	355	409	520	609	711	777	851	916	987	1086	1196
72"	325	331	363	436	522	579	680	787	860	947	1026	1117	1228	1351
84"	349	361	392	482	575	639	746	863	953	1042	1146	1233	1357	1493
96"	369	384	422	516	623	696	807	944	1049	1160	1242	1353	1488	1637
108"	398	416	456	559	673	754	889	1017	1146	1254	1380	1475	1622	1786
120"	421	444	485	596	724	810	956	1100	1233	1340	1475	1594	1753	1928
132"	436	467	515	639	771	869	1030	1177	1324	1452	1586	1716	1886	2076
144"	474	492	541	680	823	929	1094	1257	1401	1541	1704	1841	2025	2228

GROUP 5

WIDTH

SCREEN: • 1% E Screen - 122" • 1% Sheerweave 4901 - 98" • 1% Sheerweave 5000 - 98" • 10% Sheerweave 2360 - 126" • 10% Sheerweave 5000 - 98" • 3% Bellflower - 113" • 3% Delhi - 113" • 3% E Screen - 122" • 3% Sheerweave 2410 - 126" • 3% Sheerweave 2703 - 126" • 3% Sheerweave 4400 - 126" • 3% Sheerweave 4600 - 98" • 3% Sheerweave 4903 - 98" • 3% Sheerweave 5000 - 98" • 5% E Screen - 122" • 5% M Screen Deco - 98" • 5% Sheerweave 2000 - 126" • 5% Sheerweave 2390 - 126" • 5% Sheerweave 2705 - 98" • 5% Sheerweave 4000 - 126" • 5% Sheerweave 4500 - 126" • 5% Sheerweave 5000 - 98" • 7% Sheerweave 5000 - 98"

GROUP 5	24"	30"	36"	48"	60"	72"	84"	96"	108"	120"	132"	144"	156"	168"
36"	\$269	278	286	326	374	423	494	562	615	671	726	773	874	987
48"	298	307	315	345	421	476	564	651	710	780	845	905	1021	1124
60"	324	333	337	384	464	540	635	733	801	885	962	1030	1100	1210
72"	362	370	380	446	540	598	712	818	897	987	1071	1156	1239	1362
84"	369	404	411	489	594	664	784	903	993	1086	1195	1278	1362	1498
96"	380	437	447	535	646	727	858	983	1092	1206	1301	1416	1527	1681
108"	409	468	480	572	699	790	929	1065	1194	1309	1421	1541	1658	1825
120"	436	501	515	615	752	848	1004	1159	1284	1408	1540	1653	1770	1946
132"	466	536	549	664	808	913	1086	1244	1377	1515	1641	1783	1924	2118
144"	493	568	583	706	861	978	1146	1323	1481	1615	1765	1906	2049	2254
156"	549	630	646	786	962	1094	1267	1475	1660	1797	1984	2133	2282	2512
168"	633	729	745	910	1115	1269	1459	1707	1936	2081	2313	2477	2643	2907

GROUP 6

WIDTH

SCREEN: • 1% S Screen - 122" • 4% S Screen - 122" • 1% Sheerweave 2500 - 126" • 1% Sheerweave 2701 - 126" • 1% Sheerweave 4001 - 126" • 3% Bamboo - 113" • 3% Lady Amherst - 113" • 3% Sovereign - 113"

GROUP 6	24"	30"	36"	48"	60"	72"	84"	96"	108"	120"	132"	144"	156"	168"
36"	\$276	289	303	345	381	444	534	615	674	735	798	856	942	1036
48"	307	313	333	383	437	522	617	712	797	863	940	1011	1112	1225
60"	334	343	368	423	490	594	700	822	909	988	1073	1163	1280	1408
72"	353	401	410	489	593	671	787	926	1029	1117	1214	1316	1447	1594
84"	392	409	455	542	660	740	877	1033	1124	1242	1366	1469	1617	1778
96"	424	445	494	589	722	817	963	1123	1254	1386	1496	1622	1786	1964
108"	463	482	524	643	791	888	1047	1225	1371	1506	1635	1764	1940	2134
120"	491	504	559	700	856	976	1133	1334	1486	1635	1786	1920	2113	2326
132"	527	540	599	746	915	1040	1222	1437	1581	1759	1925	2092	2301	2533
144"	558	572	634	804	968	1115	1315	1537	1718	1890	2067	2251	2476	2724

BLISS Automation pricing. [Click here to view.](#)
 Somfy Automation pricing. [Click here to view.](#)
 PowerWand pricing. [Click here to view.](#)

SURCHARGE OPTIONS

Fabric Drops

WIDTH			
Medium & Large Curved Cassette, Square Cassette, 3" & 4" Fascias	24" - 48"	48-1/8" - 84"	84-1/8 - 144"
	\$107	160	266

WIDTH			
Fabric Cornice (4", 6", 8")	24" - 48"	48-1/8" - 84"	84-1/8 - 192"
	\$133	186	293

WIDTH			
Tube Size Upgrades	2"	2-1/2"	3-1/4"
	\$95	160	230

ADDITIONAL SURCHARGES		
Continuous Loop Control		\$0
TouchLift		\$0
Cordless Lift		\$120
Fabric Cornice Keystone(s)		\$55
Fabric Cornice Returns		\$50
Spring Assist Clutch		\$149
Privacy Light Block	\$4.50	per ft
Side Channels	\$19	per ft
Bottom Channels	\$19	per ft
Custom Splicing (max 2 seams per shade)		15%
Dual Bracket		\$40
18" to 36" Cordless Extension Pole		\$24

2-on-1 Shades Option: A Two-on-One shade is two individual shades housed under one continuous top treatment. The cost for the 2-on-1 shade is the sum of both shades with top treatment.

BLISS Automation pricing. [Click here to view.](#)
Somfy Automation pricing. [Click here to view.](#)
PowerWand pricing. [Click here to view.](#)

TUBE SIZE UPGRADE

Upgrade to larger size is available for shades without top treatment to best match the overall appearance for side by side shades or varying shade sizes in the same room. Tube size is determined and defaulted by the shade size and properties of the overall shade. Upgrade can only be made to larger tube size available under each operating system. For tube upgrade, first determine the tube size of the largest shade and upgrade to the same tube size to match the side by side shades or the other shades in the same room.

REMINDER: Tube upgrade is only available for shades without top treatment.

Operating System		Tube Size			
		1-1/2"	2"	2-1/2"	3-1/4"
Continuous Loop Control		X	X	X	-
Cordless Lift		X	-	-	-
TouchLift		X	-	-	-
PowerWand 1.0 Li-Ion		X	-	-	-
Powerwand 2.0 Li-Ion		X	X	-	-
Lithium-Ion Motors	Bliss™ 1.1 Li-Ion	X	-	-	-
	Bliss™ 2.0 Li-Ion	X	X	-	-
	Bliss™ 3.0 Li-Ion	-	X	X	X
	Sonesse® 28 WireFree™ RTS Li-Ion Sonesse® 28 WireFree™ Zigbee Li-Ion	X	-	-	-
	Sonesse® ULTRA 30 WireFree™ RTS Li-Ion	X	X	-	-
	Sonesse® 40 WireFree™ RTS Li-Ion	-	X	X	-
DC Motors	Bliss™ 1.1 DC	X	-	-	-
	Bliss™ 2.0 DC	X	X	-	-
	Sonesse® 28 WireFree™ RTS DC Sonesse® 28 WireFree™ Zigbee DC	X	-	-	-
	Sonesse® 30 RTS 24v DC	X	X	-	-
	Sonesse® 50 RTS AC	-	X	X	X
AC Motors	Sonesse® ULTRA 50 AC	-	X	X	X
	Bliss™ 10.0 AC	-	X	X	X

Refer to Surcharge Options for Tube Size Upgrade: Available to upgrade to larger size tube only.

PRODUCT SIZE SPECIFICATIONS – CONTINUOUS LOOP CONTROL & AUTOMATION

Collection Code	Collection Name	Max Width Non-Railroaded ** (inches)	Max Width Railroaded (inches)	Available with Seam
AS010	1% EnduroScreen	98	168	Yes

**To determine the maximum width for continuous Fabric Cornices, subtract 4 inches from the maximum non-railroad width.

- Railroad Fabrics (turned width for length) will have a visible seam when fabricated longer than the maximum roll width less 16".
- Red Box in spec chart indicates shade sizes Heat Sealed Hem Bar is recommended. For Continuous Loop Control, metal chain is also recommended for these sizes.

Top Treatment	Legend			
Medium Cassette				
3" Fascia				
Large Cassette				
Square Cassette				
Fabric Cornice				
4" Fascia				
Open Roll				

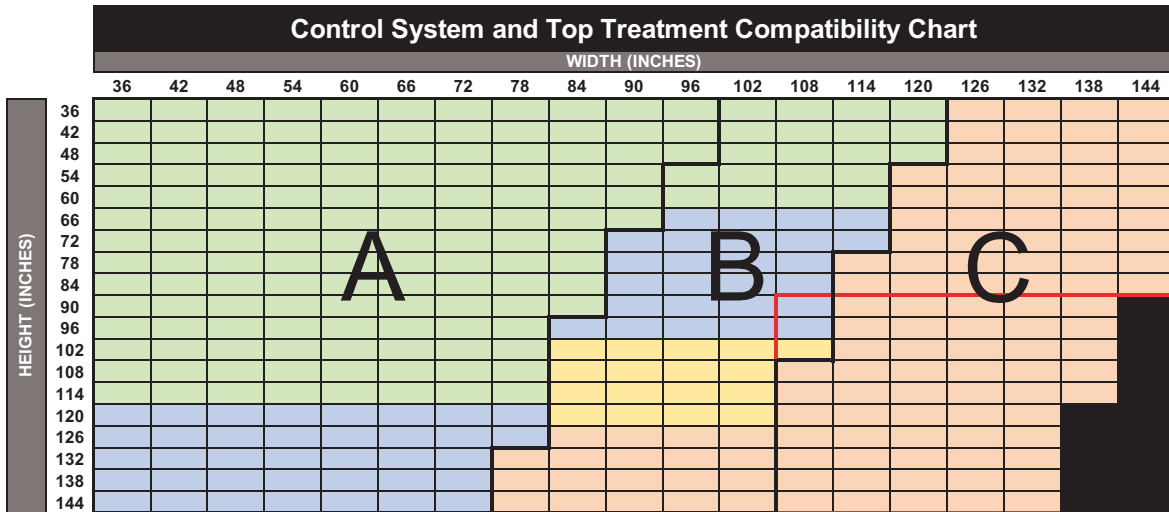

Control Systems (Minimum height for all Control Systems is 12")		Minimum Width (Single Panel)	Overall Minimum Width (2-on-1)	Specification Zone(s)*	Top Treatment
Continuous Loop Control	Continuous Loop Control (Maximum height for 12" width is 60")	12"	24"	A, B & C	All
	**Continuous Loop Control with Spring Assist	60"	NA	A, B & C	Open Roll & 4" Fascia
PowerWand	Powerwand 1.0 Li-Ion	21"	43"	A	All
	Powerwand 2.0 Li-Ion	22"	45"	A & B	(except 3" Fascia)
Lithium-ion Motors	Bliss™ 1.1 Li-Ion	21 1/2"	44"	A	All
	Bliss™ 2.0 Li-Ion	29"	59"	A & B	
	Sonesse® 28 WireFree™ RTS Li-Ion / Sonesse® 28 WireFree™ Zigbee Li-Ion	24 1/2"	50"	A	
	Sonesse® ULTRA 30 WireFree™ RTS Li-Ion	28 1/2"	58"	A & B	
DC Motors	Bliss™ 1.1 DC	16 1/2"	34"	A	All
	Bliss™ 2.0 DC	22 1/2"	46"	A & B	
	Sonesse® 28 WireFree™ RTS DC / Sonesse® 28 WireFree™ Zigbee DC	16 1/2"	34"	A	
	Sonesse® 30 RTS 24v DC	21"	NA	A & B	

**See Spring Assist Section in reference guide for details

*Not all fabrics are available in all zones

Control System and Top Treatment Compatibility Chart - High Torque Motors

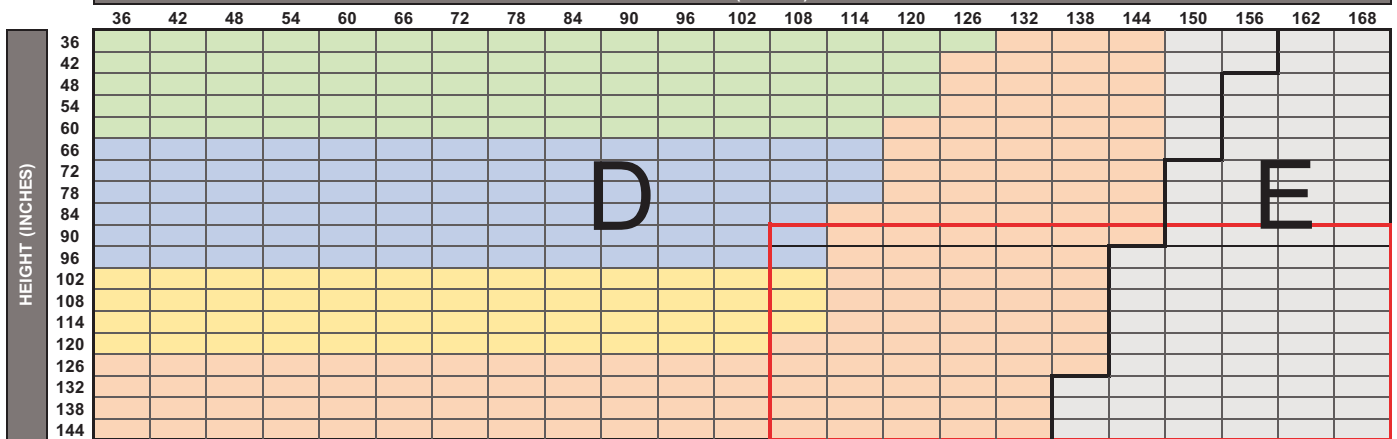

Control Systems (Minimum height for all Control Systems is 12")		Minimum Width (Single Panel)	Overall Minimum Width (2-on-1)	Specification Zone(s)*	Top Treatment
Lithium-ion Motors	Bliss™ 3.0 Li-Ion	32"	65"	D & E	All
	Sonesse® 40 WireFree™ RTS Li-Ion	31"	63"	D	
AC Motors	Bliss™ 10.0 AC	35"	NA	D & E	Open Roll, Fabric Cornice, and 4" Fascia
	Sonesse® 50 RTS AC (120V)	33"	NA	D & E	
	Sonesse® Ultra 50 AC (120V)	39"	NA	D & E	

*Not all fabrics are available in all zones

PRODUCT SIZE SPECIFICATIONS – CONTINUOUS LOOP CONTROL & AUTOMATION

Collection Code	Collection Name	Max Width Non-Railroaded ** (inches)	Max Width Railroaded (inches)	Available with Seam
AS013	1% Environs Screen	118	168	No

**To determine the maximum width for continuous Fabric Cornices, subtract 4 inches from the maximum non-railroad width. Maximum height is 102" when railroaded

- Railroad Fabrics (turned width for length) will have a visible seam when fabricated longer than the maximum roll width less 16".
- The **Red Box** in the spec chart indicates shade sizes metal chain is recommended for Continuous Loop Control.

Top Treatment	Legend			
Medium Cassette				
3" Fascia				
Large Cassette				
Square Cassette				
Fabric Cornice				
4" Fascia				
Open Roll				

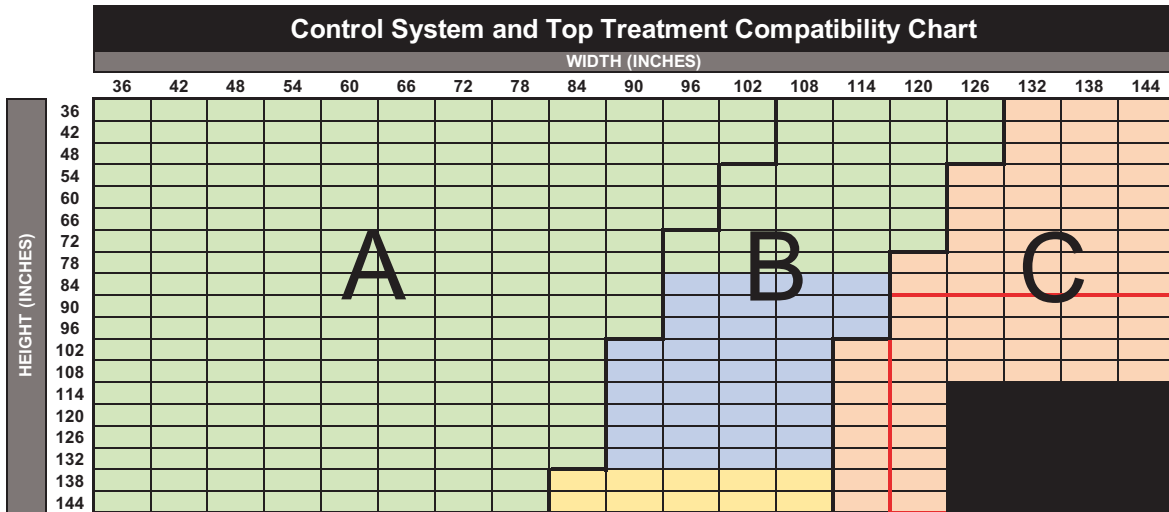

Control Systems (Minimum height for all Control Systems is 12")		Minimum Width (Single Panel)	Overall Minimum Width (2-on-1)	Specification Zone(s)*	Top Treatment
Continuous Loop Control	Continuous Loop Control (Maximum height for 12" width is 60")	12"	24"	A, B & C	All
	**Continuous Loop Control with Spring Assist	60"	NA	A, B & C	Open Roll & 4" Fascia
PowerWand	Powerwand 1.0 Li-Ion	21"	43"	A	All
	Powerwand 2.0 Li-Ion	22"	45"	A & B	(except 3" Fascia)
Lithium-ion Motors	Bliss™ 1.1 Li-Ion	21 1/2"	44"	A	All
	Bliss™ 2.0 Li-Ion	29"	59"	A & B	
	Sonesse® 28 WireFree™ RTS Li-Ion / Sonesse® 28 WireFree™ Zigbee Li-Ion	24 1/2"	50"	A	
	Sonesse® ULTRA 30 WireFree™ RTS Li-Ion	28 1/2"	58"	A & B	
DC Motors	Bliss™ 1.1 DC	16 1/2"	34"	A	All
	Bliss™ 2.0 DC	22 1/2"	46"	A & B	
	Sonesse® 28 WireFree™ RTS DC / Sonesse® 28 WireFree™ Zigbee DC	16 1/2"	34"	A	
	Sonesse® 30 RTS 24v DC	21"	NA	A & B	

**See Spring Assist Section in reference guide for details

*Not all fabrics are available in all zones

Control System and Top Treatment Compatibility Chart - High Torque Motors

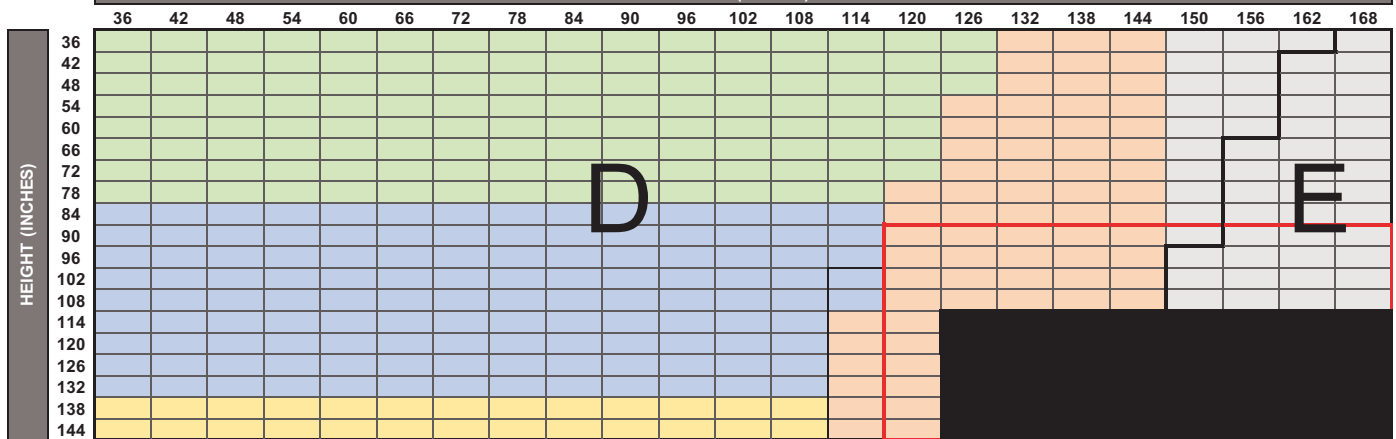

Control Systems (Minimum height for all Control Systems is 12")		Minimum Width (Single Panel)	Overall Minimum Width (2-on-1)	Specification Zone(s)*	Top Treatment
Lithium-ion Motors	Bliss™ 3.0 Li-Ion	32"	65"	D & E	All
	Sonesse® 40 WireFree™ RTS Li-Ion	31"	63"	D	
AC Motors	Bliss™ 10.0 AC	35"	NA	D & E	Open Roll, Fabric Cornice, and 4" Fascia
	Sonesse® 50 RTS AC (120V)	33"	NA	D & E	
	Sonesse® Ultra 50 AC (120V)	39"	NA	D & E	

*Not all fabrics are available in all zones

PRODUCT SIZE SPECIFICATIONS – CONTINUOUS LOOP CONTROL & AUTOMATION

Collection Code	Collection Name	Max Width Non-Railroaded ** (inches)	Max Width Railroaded (inches)	Available with Seam
RS23	1% Nordic Screen Plus	118	168	Yes

**To determine the maximum width for continuous Fabric Cornices, subtract 4 inches from the maximum non-railroad width.

- Railroad Fabrics (turned width for length) will have a visible seam when fabricated longer than the maximum roll width less 16".
- Red Box in spec chart indicates shade sizes Heat Sealed Hem Bar is recommended. For Continuous Loop Control, metal chain is also recommended for these sizes.

Top Treatment	Legend			
Medium Cassette				
3" Fascia				
Large Cassette				
Square Cassette				
Fabric Cornice				
4" Fascia				
Open Roll				

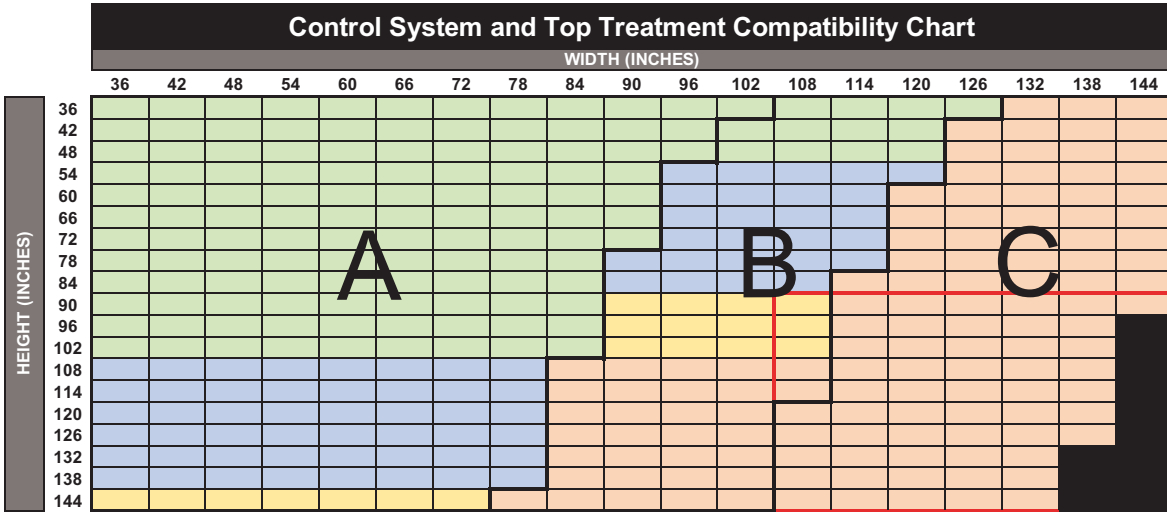

Control Systems (Minimum height for all Control Systems is 12")		Minimum Width (Single Panel)	Overall Minimum Width (2-on-1)	Specification Zone(s)*	Top Treatment
Continuous Loop Control	Continuous Loop Control (Maximum height for 12" width is 60")	12"	24"	A, B & C	All
	**Continuous Loop Control with Spring Assist	60"	NA	A, B & C	Open Roll & 4" Fascia
PowerWand	Powerwand 1.0 Li-Ion	21"	43"	A	All
	Powerwand 2.0 Li-Ion	22"	45"	A & B	(except 3" Fascia)
Lithium-ion Motors	Bliss™ 1.1 Li-Ion	21 1/2"	44"	A	All
	Bliss™ 2.0 Li-Ion	29"	59"	A & B	
	Sonesse® 28 WireFree™ RTS Li-Ion / Sonesse® 28 WireFree™ Zigbee Li-Ion	24 1/2"	50"	A	
	Sonesse® ULTRA 30 WireFree™ RTS Li-Ion	28 1/2"	58"	A & B	
DC Motors	Bliss™ 1.1 DC	16 1/2"	34"	A	All
	Bliss™ 2.0 DC	22 1/2"	46"	A & B	
	Sonesse® 28 WireFree™ RTS DC / Sonesse® 28 WireFree™ Zigbee DC	16 1/2"	34"	A	
	Sonesse® 30 RTS 24v DC	21"	NA	A & B	

**See Spring Assist Section in reference guide for details

*Not all fabrics are available in all zones

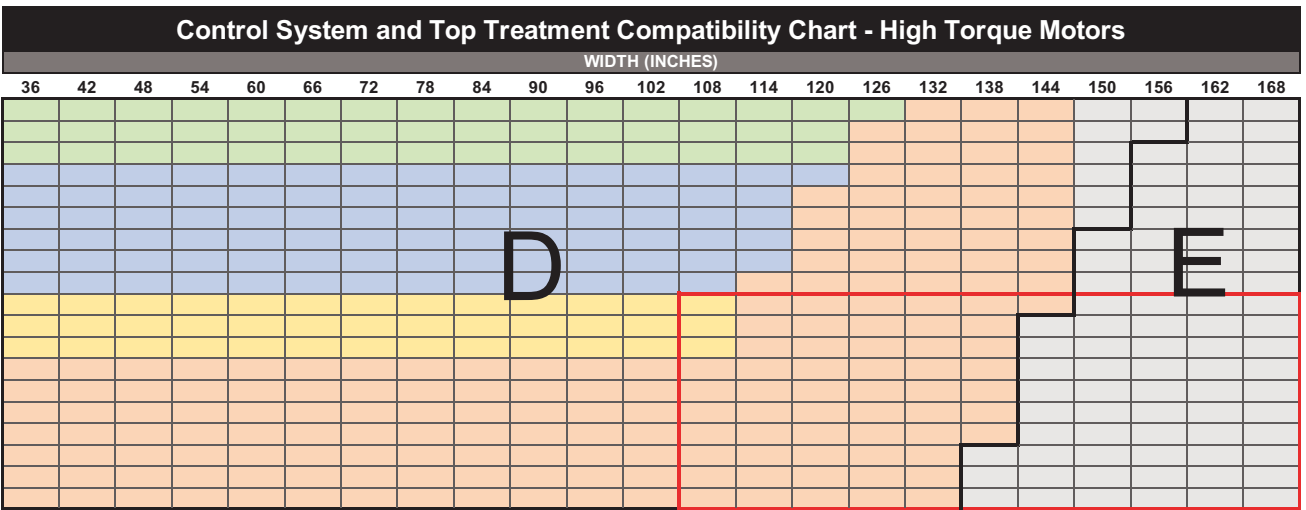

Control Systems (Minimum height for all Control Systems is 12")		Minimum Width (Single Panel)	Overall Minimum Width (2-on-1)	Specification Zone(s)*	Top Treatment
Lithium-ion Motors	Bliss™ 3.0 Li-Ion	32"	65"	D & E	All
	Sonesse® 40 WireFree™ RTS Li-Ion	31"	63"	D	
AC Motors	Bliss™ 10.0 AC	35"	NA	D & E	Open Roll, Fabric Cornice, and 4" Fascia
	Sonesse® 50 RTS AC (120V)	33"	NA	D & E	
	Sonesse® Ultra 50 AC (120V)	39"	NA	D & E	

*Not all fabrics are available in all zones

PRODUCT SIZE SPECIFICATIONS – CONTINUOUS LOOP CONTROL & AUTOMATION

Collection Code	Collection Name	Max Width Non-Railroaded ** (inches)	Max Width Railroaded (inches)	Available with Seam
R80	1% E Screen	122	168	Yes

**To determine the maximum width for continuous Fabric Cornices, subtract 4 inches from the maximum non-railroad width.

Top Treatment	Legend			
Medium Cassette				
3" Fascia				
Large Cassette				
Square Cassette				
Fabric Cornice				
4" Fascia				
Open Roll				

- Railroad Fabrics (turned width for length) will have a visible seam when fabricated longer than the maximum roll width less 16".
- Red Box in spec chart indicates shade sizes Heat Sealed Hem Bar is recommended. For Continuous Loop Control, metal chain is also recommended for these sizes.

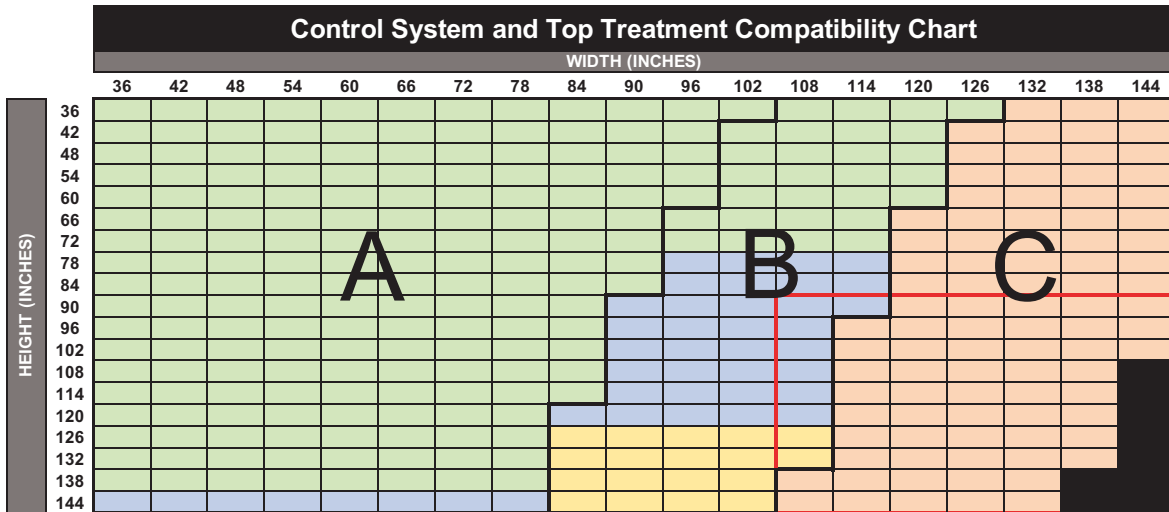

Control Systems (Minimum height for all Control Systems is 12")		Minimum Width (Single Panel)	Overall Minimum Width (2-on-1)	Specification Zone(s)*	Top Treatment
Continuous Loop Control	Continuous Loop Control (Maximum height for 12" width is 60")	12"	24"	A, B & C	All
	**Continuous Loop Control with Spring Assist	60"	NA	A, B & C	Open Roll & 4" Fascia
PowerWand	Powerwand 1.0 Li-Ion	21"	43"	A	All
	Powerwand 2.0 Li-Ion	22"	45"	A & B	(except 3" Fascia)
Lithium-ion Motors	Bliss™ 1.1 Li-Ion	21 1/2"	44"	A	All
	Bliss™ 2.0 Li-Ion	29"	59"	A & B	
	Sonessé® 28 WireFree™ RTS Li-Ion / Sonessé® 28 WireFree™ Zigbee Li-Ion	24 1/2"	50"	A	
	Sonessé® ULTRA 30 WireFree™ RTS Li-Ion	28 1/2"	58"	A & B	
DC Motors	Bliss™ 1.1 DC	16 1/2"	34"	A	All
	Bliss™ 2.0 DC	22 1/2"	46"	A & B	
	Sonessé® 28 WireFree™ RTS DC / Sonessé® 28 WireFree™ Zigbee DC	16 1/2"	34"	A	
	Sonessé® 30 RTS 24v DC	21"	NA	A & B	

**See Spring Assist Section in reference guide for details

*Not all fabrics are available in all zones

Control System and Top Treatment Compatibility Chart - High Torque Motors

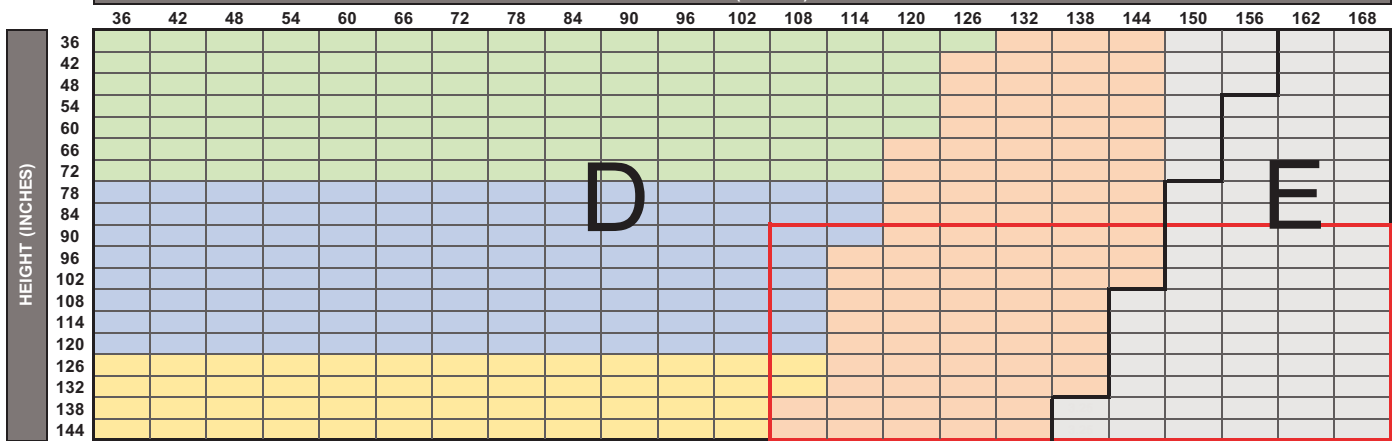

Control Systems (Minimum height for all Control Systems is 12")		Minimum Width (Single Panel)	Overall Minimum Width (2-on-1)	Specification Zone(s)*	Top Treatment
Lithium-ion Motors	Bliss™ 3.0 Li-Ion	32"	65"	D & E	All
	Sonessé® 40 WireFree™ RTS Li-Ion	31"	63"	D	
AC Motors	Bliss™ 10.0 AC	35"	NA	D & E	Open Roll, Fabric Cornice, and 4" Fascia
	Sonessé® 50 RTS AC (120V)	33"	NA	D & E	
	Sonessé® Ultra 50 AC (120V)	39"	NA	D & E	

*Not all fabrics are available in all zones

PRODUCT SIZE SPECIFICATIONS – CONTINUOUS LOOP CONTROL & AUTOMATION

Collection Code	Collection Name	Max Width Non-Railroaded ** (inches)	Max Width Railroaded (inches)	Available with Seam
RS7	1% S Screen	122	NA	No

**To determine the maximum width for continuous Fabric Cornices, subtract 4 inches from the maximum non-railroad width. Maximum height with Spring Assist on 4" Fascia is 126"

· Railroad Fabrics (turned width for length) will have a visible seam when fabricated longer than the maximum roll width less 16".
 · Red Box in spec chart indicates shade sizes Heat Sealed Hem Bar is recommended. For Continuous Loop Control, metal chain is also recommended for these sizes.

Top Treatment	Legend			
Medium Cassette				
3" Fascia				
Large Cassette				
Square Cassette				
Fabric Cornice				
4" Fascia				
Open Roll				

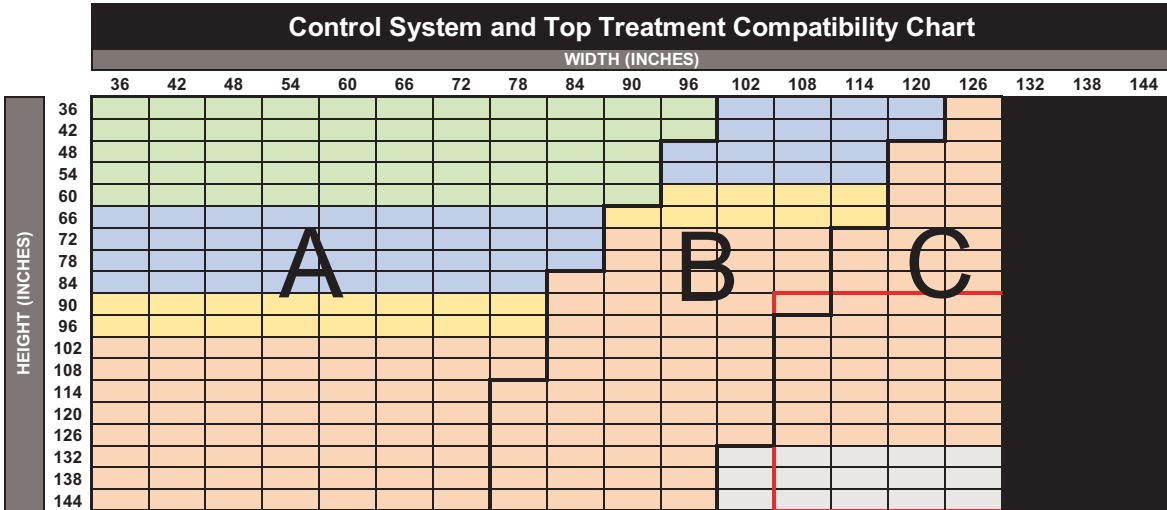

Control Systems (Minimum height for all Control Systems is 12")		Minimum Width (Single Panel)	Overall Minimum Width (2-on-1)	Specification Zone(s)*	Top Treatment
Continuous Loop Control	Continuous Loop Control (Maximum height for 12" width is 60")	12"	24"	A, B & C	All
	**Continuous Loop Control with Spring Assist	60"	NA	A, B & C	Open Roll & 4" Fascia
PowerWand	Powerwand 1.0 Li-Ion	21"	43"	A	All
	Powerwand 2.0 Li-Ion	22"	45"	A & B	(except 3" Fascia)
Lithium-ion Motors	Bliss™ 1.1 Li-Ion	21 1/2"	44"	A	All
	Bliss™ 2.0 Li-Ion	29"	59"	A & B	
	Sonessé® 28 WireFree™ RTS Li-Ion / Sonessé® 28 WireFree™ Zigbee Li-Ion	24 1/2"	50"	A	
	Sonessé® ULTRA 30 WireFree™ RTS Li-Ion	28 1/2"	58"	A & B	
DC Motors	Bliss™ 1.1 DC	16 1/2"	34"	A	All
	Bliss™ 2.0 DC	22 1/2"	46"	A & B	
	Sonessé® 28 WireFree™ RTS DC / Sonessé® 28 WireFree™ Zigbee DC	16 1/2"	34"	A	
	Sonessé® 30 RTS 24v DC	21"	NA	A & B	

**See Spring Assist Section in reference guide for details

*Not all fabrics are available in all zones

Control System and Top Treatment Compatibility Chart - High Torque Motors

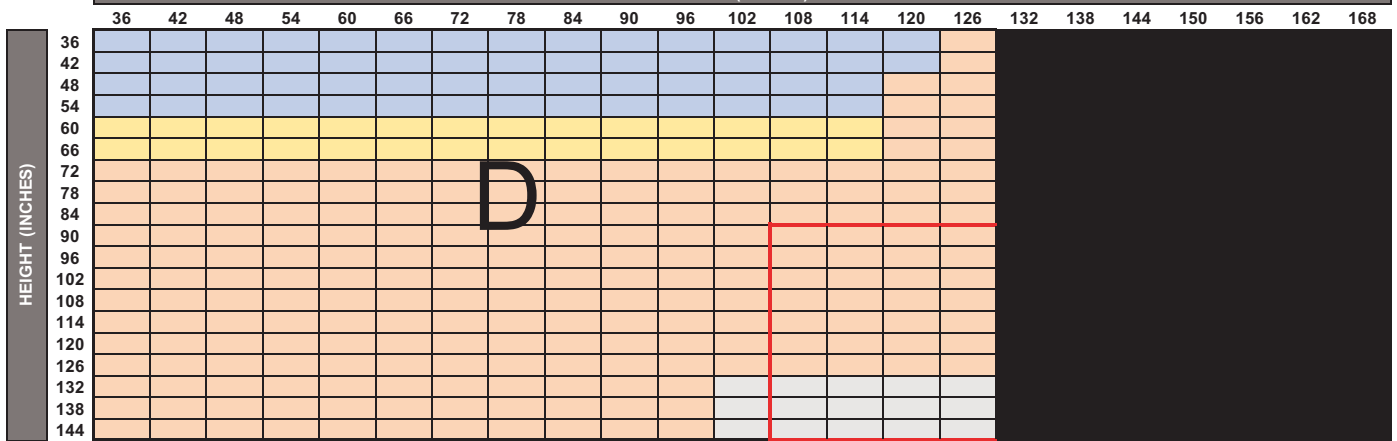

Control Systems (Minimum height for all Control Systems is 12")		Minimum Width (Single Panel)	Overall Minimum Width (2-on-1)	Specification Zone(s)*	Top Treatment
Lithium-ion Motors	Bliss™ 3.0 Li-Ion	32"	65"	D & E	All
	Sonessé® 40 WireFree™ RTS Li-Ion	31"	63"	D	
AC Motors	Bliss™ 10.0 AC	35"	NA	D & E	Open Roll, Fabric Cornice, and 4" Fascia
	Sonessé® 50 RTS AC (120V)	33"	NA	D & E	
	Sonessé® Ultra 50 AC (120V)	39"	NA	D & E	

*Not all fabrics are available in all zones

PRODUCT SIZE SPECIFICATIONS – CONTINUOUS LOOP CONTROL & AUTOMATION

Collection Code	Collection Name	Max Width Non-Railroaded ** (inches)	Max Width Railroaded (inches)	Available with Seam
R01	1% Sheerweave 2500	126	168	Yes

**To determine the maximum width for continuous Fabric Cornices, subtract 4 inches from the maximum non-railroad width.

- Railroad Fabrics (turned width for length) will have a visible seam when fabricated longer than the maximum roll width less 16".
- Red Box in spec chart indicates shade sizes Heat Sealed Hem Bar is recommended. For Continuous Loop Control, metal chain is also recommended for these sizes.

Top Treatment	Legend			
Medium Cassette	Green	Blue	Yellow	Orange
3" Fascia	Green	Blue	Yellow	Orange
Large Cassette	Green	Blue	Yellow	Orange
Square Cassette	Green	Blue	Yellow	Orange
Fabric Cornice	Green	Blue	Yellow	Orange
4" Fascia	Green	Blue	Yellow	Orange
Open Roll	Green	Blue	Yellow	Orange

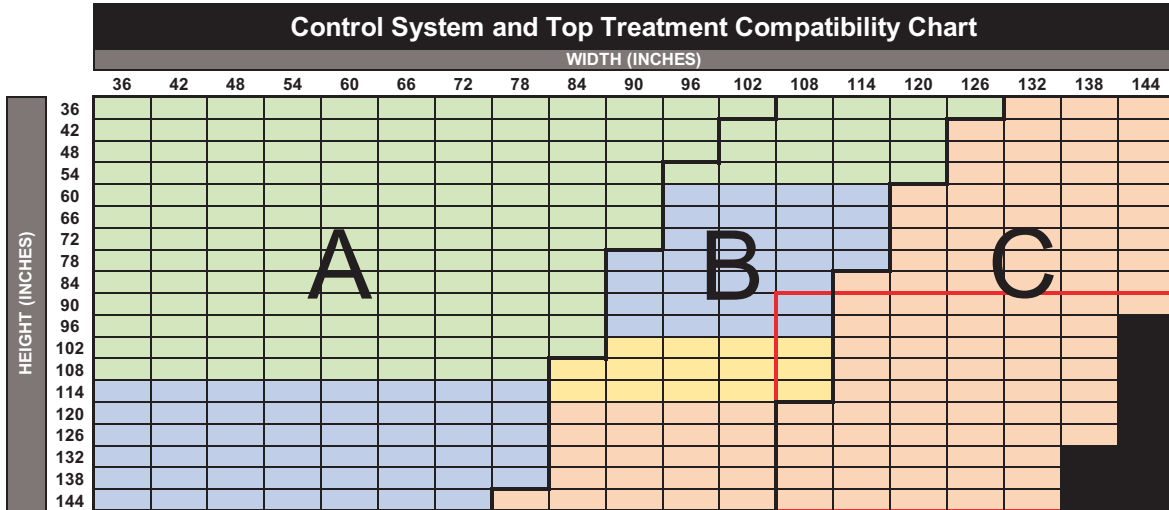

Control Systems (Minimum height for all Control Systems is 12")		Minimum Width (Single Panel)	Overall Minimum Width (2-on-1)	Specification Zone(s)*	Top Treatment
Continuous Loop Control	Continuous Loop Control (Maximum height for 12" width is 60")	12"	24"	A, B & C	All
	**Continuous Loop Control with Spring Assist	60"	NA	A, B & C	Open Roll & 4" Fascia
PowerWand	Powerwand 1.0 Li-Ion	21"	43"	A	All
	Powerwand 2.0 Li-Ion	22"	45"	A & B	(except 3" Fascia)
Lithium-ion Motors	Bliss™ 1.1 Li-Ion	21 1/2"	44"	A	All
	Bliss™ 2.0 Li-Ion	29"	59"	A & B	
	Sonessé® 28 WireFree™ RTS Li-Ion / Sonessé® 28 WireFree™ Zigbee Li-Ion	24 1/2"	50"	A	
	Sonessé® ULTRA 30 WireFree™ RTS Li-Ion	28 1/2"	58"	A & B	
DC Motors	Bliss™ 1.1 DC	16 1/2"	34"	A	All
	Bliss™ 2.0 DC	22 1/2"	46"	A & B	
	Sonessé® 28 WireFree™ RTS DC / Sonessé® 28 WireFree™ Zigbee DC	16 1/2"	34"	A	
	Sonessé® 30 RTS 24v DC	21"	NA	A & B	

**See Spring Assist Section in reference guide for details

*Not all fabrics are available in all zones

Control System and Top Treatment Compatibility Chart - High Torque Motors

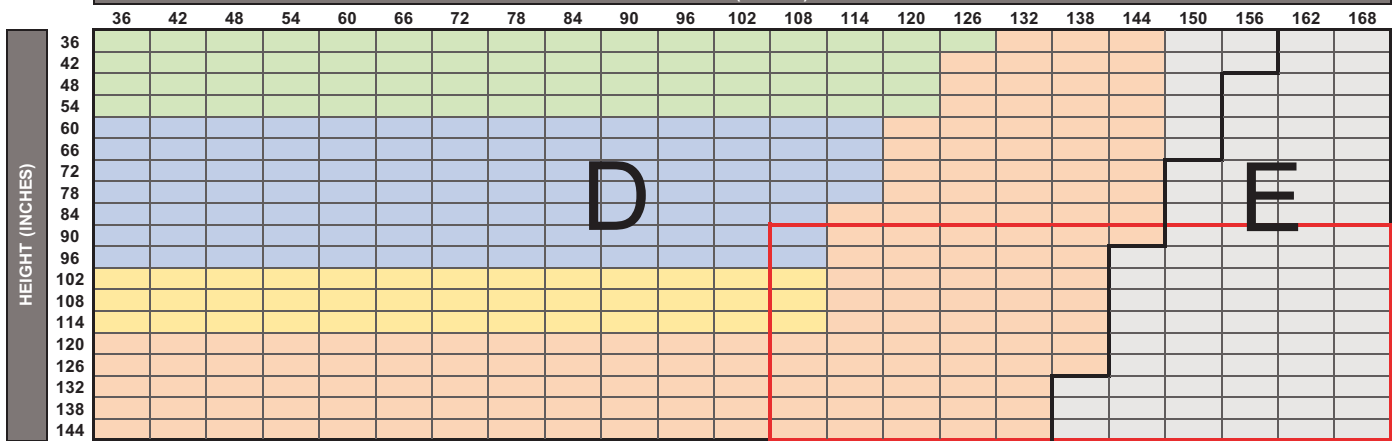

Control Systems (Minimum height for all Control Systems is 12")		Minimum Width (Single Panel)	Overall Minimum Width (2-on-1)	Specification Zone(s)*	Top Treatment
Lithium-ion Motors	Bliss™ 3.0 Li-Ion	32"	65"	D & E	All
	Sonessé® 40 WireFree™ RTS Li-Ion	31"	63"	D	
AC Motors	Bliss™ 10.0 AC	35"	NA	D & E	Open Roll, Fabric Cornice, and 4" Fascia
	Sonessé® 50 RTS AC (120V)	33"	NA	D & E	
	Sonessé® Ultra 50 AC (120V)	39"	NA	D & E	

*Not all fabrics are available in all zones

PRODUCT SIZE SPECIFICATIONS – CONTINUOUS LOOP CONTROL & AUTOMATION

Collection Code	Collection Name	Max Width Non-Railroaded ** (inches)	Max Width Railroaded (inches)	Available with Seam
RS21	1% Sheerweave 2701	126	168	Yes

**To determine the maximum width for continuous Fabric Cornices, subtract 4 inches from the maximum non-railroad width.

- Railroad Fabrics (turned width for length) will have a visible seam when fabricated longer than the maximum roll width less 16".
- Red Box in spec chart indicates shade sizes Heat Sealed Hem Bar is recommended. For Continuous Loop Control, metal chain is also recommended for these sizes.

Top Treatment	Legend			
Medium Cassette				
3" Fascia				
Large Cassette				
Square Cassette				
Fabric Cornice				
4" Fascia				
Open Roll				

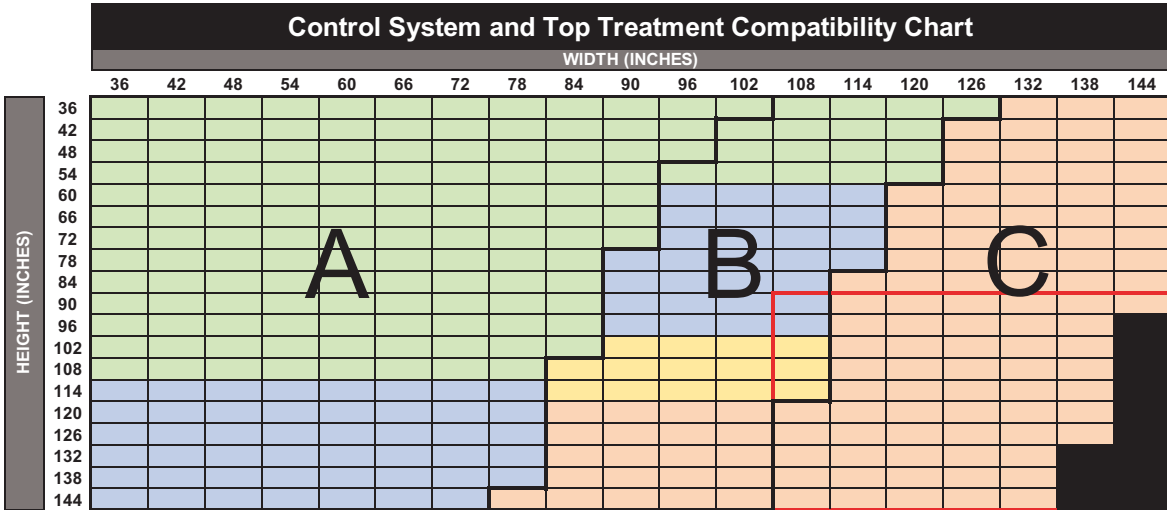

Control Systems (Minimum height for all Control Systems is 12")		Minimum Width (Single Panel)	Overall Minimum Width (2-on-1)	Specification Zone(s)*	Top Treatment
Continuous Loop Control	Continuous Loop Control (Maximum height for 12" width is 60")	12"	24"	A, B & C	All
	**Continuous Loop Control with Spring Assist	60"	NA	A, B & C	Open Roll & 4" Fascia
PowerWand	Powerwand 1.0 Li-Ion	21"	43"	A	All
	Powerwand 2.0 Li-Ion	22"	45"	A & B	(except 3" Fascia)
Lithium-ion Motors	Bliss™ 1.1 Li-Ion	21 1/2"	44"	A	All
	Bliss™ 2.0 Li-Ion	29"	59"	A & B	
	Sonessé® 28 WireFree™ RTS Li-Ion / Sonessé® 28 WireFree™ Zigbee Li-Ion	24 1/2"	50"	A	
	Sonessé® ULTRA 30 WireFree™ RTS Li-Ion	28 1/2"	58"	A & B	
DC Motors	Bliss™ 1.1 DC	16 1/2"	34"	A	All
	Bliss™ 2.0 DC	22 1/2"	46"	A & B	
	Sonessé® 28 WireFree™ RTS DC / Sonessé® 28 WireFree™ Zigbee DC	16 1/2"	34"	A	
	Sonessé® 30 RTS 24v DC	21"	NA	A & B	

**See Spring Assist Section in reference guide for details

*Not all fabrics are available in all zones

Control System and Top Treatment Compatibility Chart - High Torque Motors

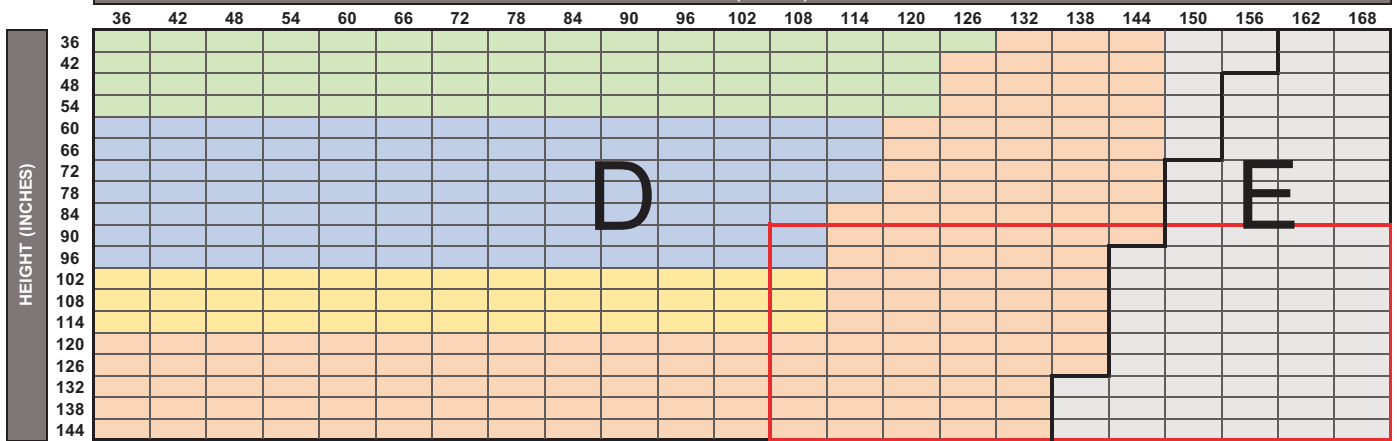

Control Systems (Minimum height for all Control Systems is 12")		Minimum Width (Single Panel)	Overall Minimum Width (2-on-1)	Specification Zone(s)*	Top Treatment
Lithium-ion Motors	Bliss™ 3.0 Li-Ion	32"	65"	D & E	All
	Sonessé® 40 WireFree™ RTS Li-Ion	31"	63"	D	
AC Motors	Bliss™ 10.0 AC	35"	NA	D & E	Open Roll, Fabric Cornice, and 4" Fascia
	Sonessé® 50 RTS AC (120V)	33"	NA	D & E	
	Sonessé® Ultra 50 AC (120V)	39"	NA	D & E	

*Not all fabrics are available in all zones

PRODUCT SIZE SPECIFICATIONS – CONTINUOUS LOOP CONTROL & AUTOMATION

Collection Code	Collection Name	Max Width Non-Railroaded ** (inches)	Max Width Railroaded (inches)	Available with Seam
P4001	1% Sheerweave 4001	126	168	Yes

**To determine the maximum width for continuous Fabric Cornices, subtract 4 inches from the maximum non-railroad width.

- Railroad Fabrics (turned width for length) will have a visible seam when fabricated longer than the maximum roll width less 16".
- Red Box in spec chart indicates shade sizes Heat Sealed Hem Bar is recommended. For Continuous Loop Control, metal chain is also recommended for these sizes.

Top Treatment	Legend			
Medium Cassette	Green	Blue	Yellow	Orange
3" Fascia	Green	Blue	Yellow	Orange
Large Cassette	Green	Blue	Yellow	Orange
Square Cassette	Green	Blue	Yellow	Orange
Fabric Cornice	Green	Blue	Yellow	Orange
4" Fascia	Green	Blue	Yellow	Orange
Open Roll	Green	Blue	Yellow	Orange

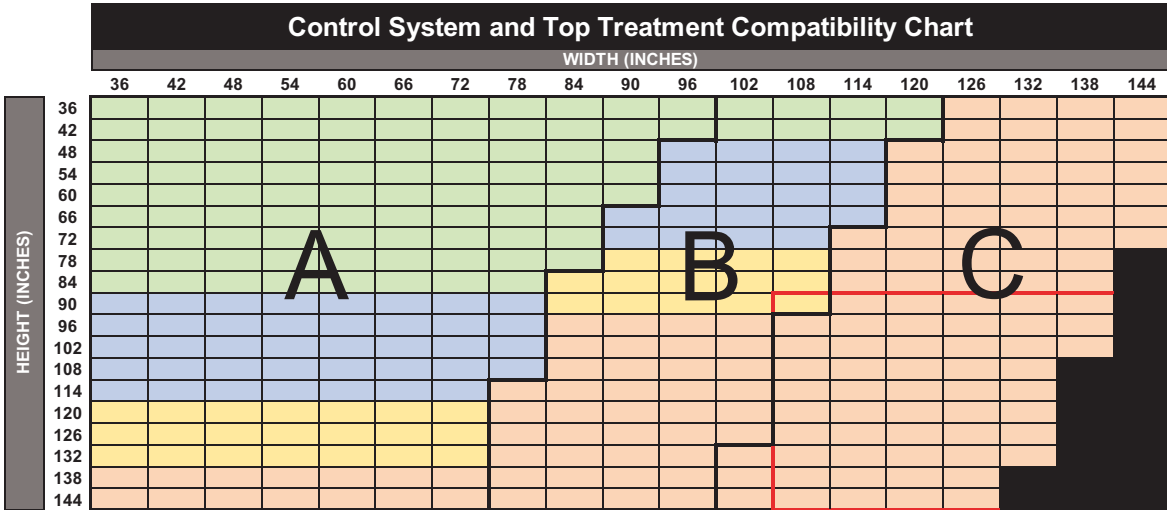

Control Systems (Minimum height for all Control Systems is 12")		Minimum Width (Single Panel)	Overall Minimum Width (2-on-1)	Specification Zone(s)*	Top Treatment
Continuous Loop Control	Continuous Loop Control (Maximum height for 12" width is 60")	12"	24"	A, B & C	All
	**Continuous Loop Control with Spring Assist	60"	NA	A, B & C	Open Roll & 4" Fascia
PowerWand	Powerwand 1.0 Li-Ion	21"	43"	A	All
	Powerwand 2.0 Li-Ion	22"	45"	A & B	(except 3" Fascia)
Lithium-ion Motors	Bliss™ 1.1 Li-Ion	21 1/2"	44"	A	All
	Bliss™ 2.0 Li-Ion	29"	59"	A & B	
	Sonesse® 28 WireFree™ RTS Li-Ion / Sonesse® 28 WireFree™ Zigbee Li-Ion	24 1/2"	50"	A	
	Sonesse® ULTRA 30 WireFree™ RTS Li-Ion	28 1/2"	58"	A & B	
DC Motors	Bliss™ 1.1 DC	16 1/2"	34"	A	All
	Bliss™ 2.0 DC	22 1/2"	46"	A & B	
	Sonesse® 28 WireFree™ RTS DC / Sonesse® 28 WireFree™ Zigbee DC	16 1/2"	34"	A	
	Sonesse® 30 RTS 24v DC	21"	NA	A & B	

**See Spring Assist Section in reference guide for details

*Not all fabrics are available in all zones

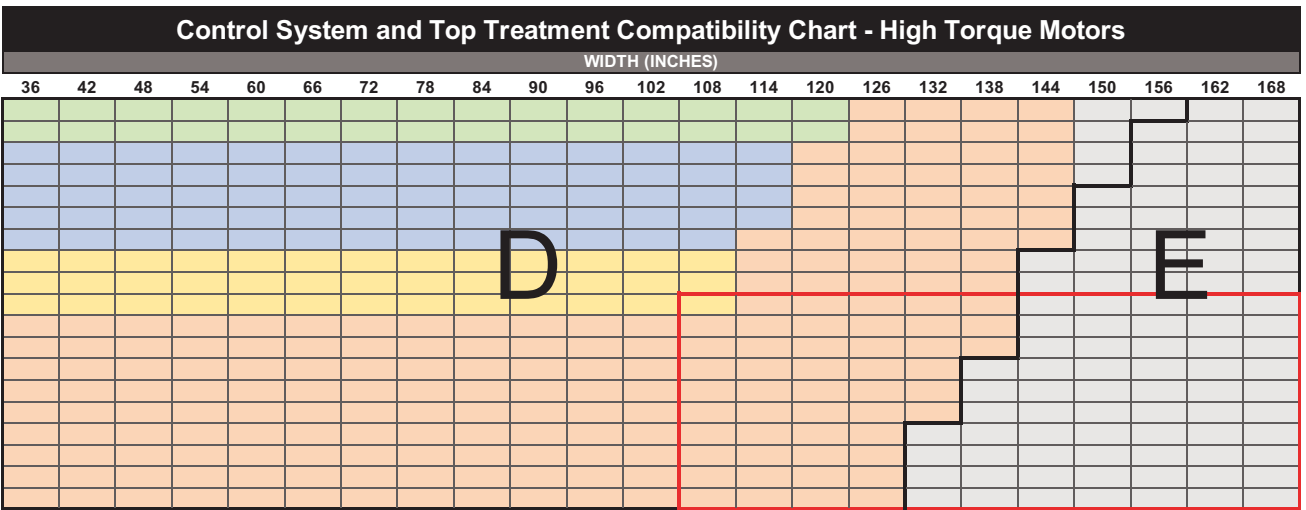

Control Systems (Minimum height for all Control Systems is 12")		Minimum Width (Single Panel)	Overall Minimum Width (2-on-1)	Specification Zone(s)*	Top Treatment
Lithium-ion Motors	Bliss™ 3.0 Li-Ion	32"	65"	D & E	All
	Sonesse® 40 WireFree™ RTS Li-Ion	31"	63"	D	
AC Motors	Bliss™ 10.0 AC	35"	NA	D & E	Open Roll, Fabric Cornice, and 4" Fascia
	Sonesse® 50 RTS AC (120V)	33"	NA	D & E	
	Sonesse® Ultra 50 AC (120V)	39"	NA	D & E	

*Not all fabrics are available in all zones

PRODUCT SIZE SPECIFICATIONS – CONTINUOUS LOOP CONTROL & AUTOMATION

Collection Code	Collection Name	Max Width Non-Railroaded ** (inches)	Max Width Railroaded (inches)	Available with Seam
P4901	1% Sheerweave 4901	98	168	Yes

**To determine the maximum width for continuous Fabric Cornices, subtract 4 inches from the maximum non-railroad width.

- Railroad Fabrics (turned width for length) will have a visible seam when fabricated longer than the maximum roll width less 16".
- Red Box in spec chart indicates shade sizes Heat Sealed Hem Bar is recommended. For Continuous Loop Control, metal chain is also recommended for these sizes.

Top Treatment	Legend			
Medium Cassette				
3" Fascia				
Large Cassette				
Square Cassette				
Fabric Cornice				
4" Fascia				
Open Roll				

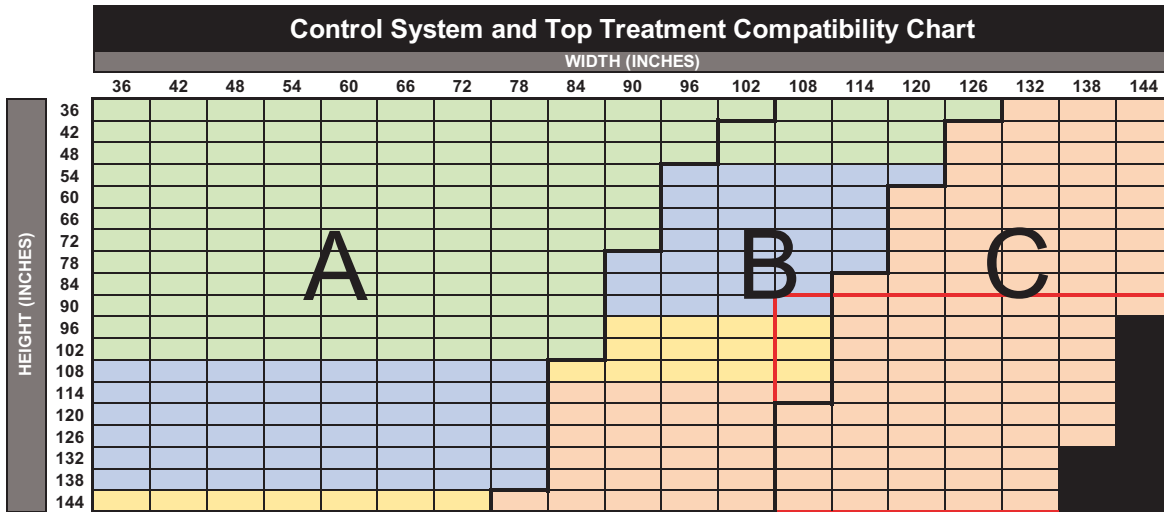

Control Systems (Minimum height for all Control Systems is 12")		Minimum Width (Single Panel)	Overall Minimum Width (2-on-1)	Specification Zone(s)*	Top Treatment
Continuous Loop Control	Continuous Loop Control (Maximum height for 12" width is 60")	12"	24"	A, B & C	All
	**Continuous Loop Control with Spring Assist	60"	NA	A, B & C	Open Roll & 4" Fascia
PowerWand	Powerwand 1.0 Li-Ion	21"	43"	A	All
	Powerwand 2.0 Li-Ion	22"	45"	A & B	(except 3" Fascia)
Lithium-ion Motors	Bliss™ 1.1 Li-Ion	21 1/2"	44"	A	All
	Bliss™ 2.0 Li-Ion	29"	59"	A & B	
	Sonesse® 28 WireFree™ RTS Li-Ion / Sonesse® 28 WireFree™ Zigbee Li-Ion	24 1/2"	50"	A	
	Sonesse® ULTRA 30 WireFree™ RTS Li-Ion	28 1/2"	58"	A & B	
DC Motors	Bliss™ 1.1 DC	16 1/2"	34"	A	All
	Bliss™ 2.0 DC	22 1/2"	46"	A & B	
	Sonesse® 28 WireFree™ RTS DC / Sonesse® 28 WireFree™ Zigbee DC	16 1/2"	34"	A	
	Sonesse® 30 RTS 24v DC	21"	NA	A & B	

**See Spring Assist Section in reference guide for details

*Not all fabrics are available in all zones

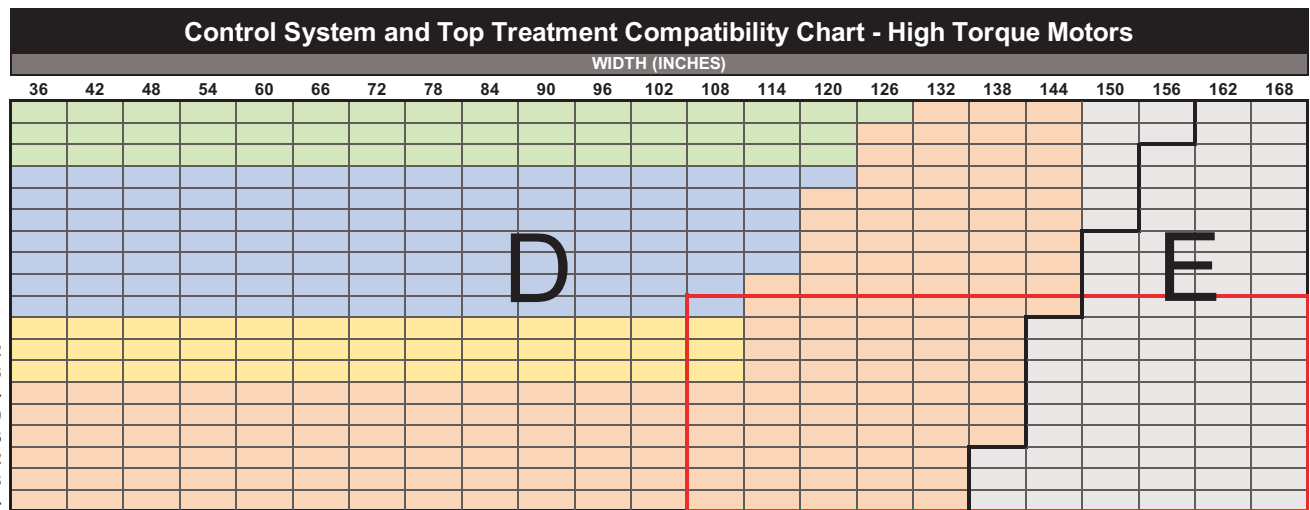

Control Systems (Minimum height for all Control Systems is 12")		Minimum Width (Single Panel)	Overall Minimum Width (2-on-1)	Specification Zone(s)*	Top Treatment
Lithium-ion Motors	Bliss™ 3.0 Li-Ion	32"	65"	D & E	All
	Sonesse® 40 WireFree™ RTS Li-Ion	31"	63"	D	
AC Motors	Bliss™ 10.0 AC	35"	NA	D & E	Open Roll, Fabric Cornice, and 4" Fascia
	Sonesse® 50 RTS AC (120V)	33"	NA	D & E	
	Sonesse® Ultra 50 AC (120V)	39"	NA	D & E	

*Not all fabrics are available in all zones

PRODUCT SIZE SPECIFICATIONS – CONTINUOUS LOOP CONTROL & AUTOMATION

Collection Code	Collection Name	Max Width Non-Railroaded ** (inches)	Max Width Railroaded (inches)	Available with Seam
P5001	1% Sheerweave 5000	98	168	Yes

**To determine the maximum width for continuous Fabric Cornices, subtract 4 inches from the maximum non-railroad width. Maximum height of Spring Assist with 4" Fascia is 108"

· Railroad Fabrics (turned width for length) will have a visible seam when fabricated longer than the maximum roll width less 16".

· Red Box in spec chart indicates shade sizes Heat Sealed Hem Bar is recommended. For Continuous Loop Control, metal chain is also recommended for these sizes.

Top Treatment	Legend			
Medium Cassette	Green	Blue	Yellow	Orange
3" Fascia	Green	Blue	Yellow	Orange
Large Cassette	Green	Blue	Yellow	Orange
Square Cassette	Green	Blue	Yellow	Orange
Fabric Cornice	Green	Blue	Yellow	Orange
4" Fascia	Green	Blue	Yellow	Orange
Open Roll	Green	Blue	Yellow	Orange

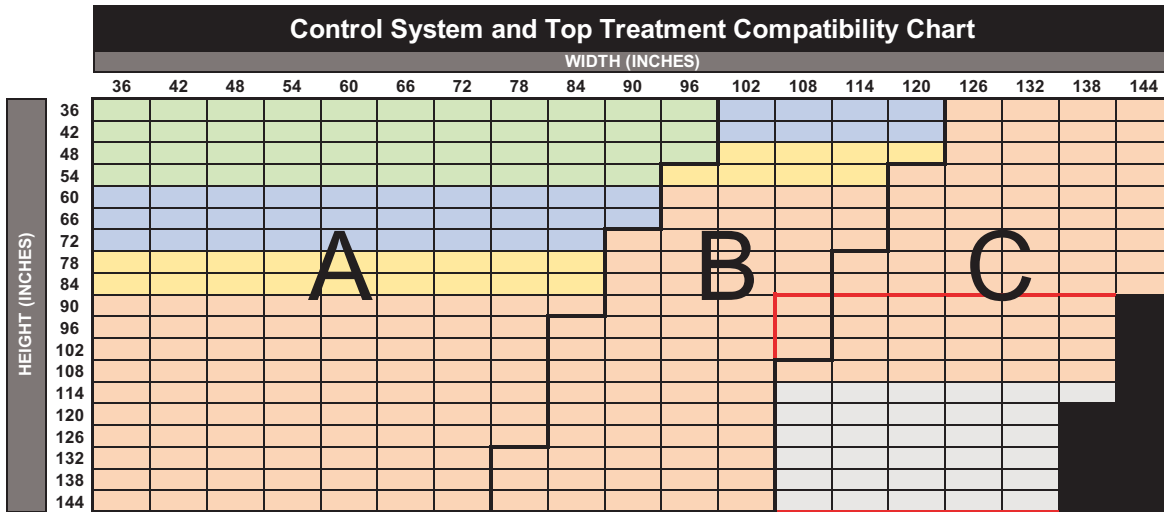

Control Systems (Minimum height for all Control Systems is 12")		Minimum Width (Single Panel)	Overall Minimum Width (2-on-1)	Specification Zone(s)*	Top Treatment
Continuous Loop Control	Continuous Loop Control (Maximum height for 12" width is 60")	12"	24"	A, B & C	All
	**Continuous Loop Control with Spring Assist	60"	NA	A, B & C	Open Roll & 4" Fascia
PowerWand	Powerwand 1.0 Li-Ion	21"	43"	A	All (except 3" Fascia)
	Powerwand 2.0 Li-Ion	22"	45"	A & B	
Lithium-ion Motors	Bliss™ 1.1 Li-Ion	21 1/2"	44"	A	All
	Bliss™ 2.0 Li-Ion	29"	59"	A & B	
	Sonesse® 28 WireFree™ RTS Li-Ion / Sonesse® 28 WireFree™ Zigbee Li-Ion	24 1/2"	50"	A	
	Sonesse® ULTRA 30 WireFree™ RTS Li-Ion	28 1/2"	58"	A & B	
DC Motors	Bliss™ 1.1 DC	16 1/2"	34"	A	All
	Bliss™ 2.0 DC	22 1/2"	46"	A & B	
	Sonesse® 28 WireFree™ RTS DC / Sonesse® 28 WireFree™ Zigbee DC	16 1/2"	34"	A	
	Sonesse® 30 RTS 24v DC	21"	NA	A & B	

**See Spring Assist Section in reference guide for details

*Not all fabrics are available in all zones

Control System and Top Treatment Compatibility Chart - High Torque Motors

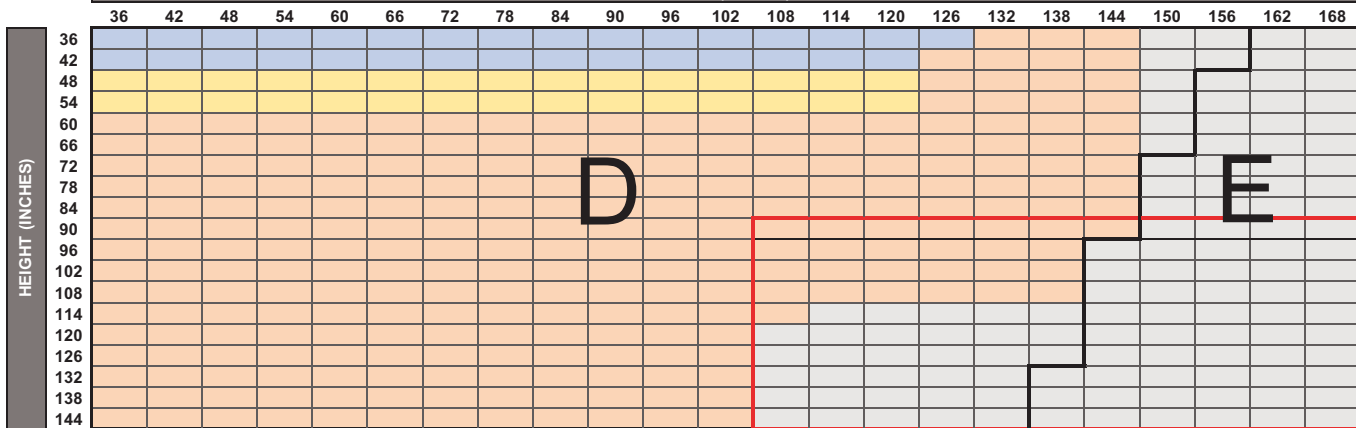

Control Systems (Minimum height for all Control Systems is 12")		Minimum Width (Single Panel)	Overall Minimum Width (2-on-1)	Specification Zone(s)*	Top Treatment
Lithium-ion Motors	Bliss™ 3.0 Li-Ion	32"	65"	D & E	All
	Sonesse® 40 WireFree™ RTS Li-Ion	31"	63"	D	
AC Motors	Bliss™ 10.0 AC	35"	NA	D & E	Open Roll, Fabric Cornice, and 4" Fascia
	Sonesse® 50 RTS AC (120V)	33"	NA	D & E	
	Sonesse® Ultra 50 AC (120V)	39"	NA	D & E	

*Not all fabrics are available in all zones

PRODUCT SIZE SPECIFICATIONS – CONTINUOUS LOOP CONTROL & AUTOMATION

Collection Code	Collection Name	Max Width Non-Railroaded ** (inches)	Max Width Railroaded (inches)	Available with Seam
R81	3% E Screen	122	168	Yes

**To determine the maximum width for continuous Fabric Cornices, subtract 4 inches from the maximum non-railroad width.

- Railroad Fabrics (turned width for length) will have a visible seam when fabricated longer than the maximum roll width less 16".
- Red Box in spec chart indicates shade sizes Heat Sealed Hem Bar is recommended. For Continuous Loop Control, metal chain is also recommended for these sizes.

Top Treatment	Legend			
Medium Cassette				
3" Fascia				
Large Cassette				
Square Cassette				
Fabric Cornice				
4" Fascia				
Open Roll				

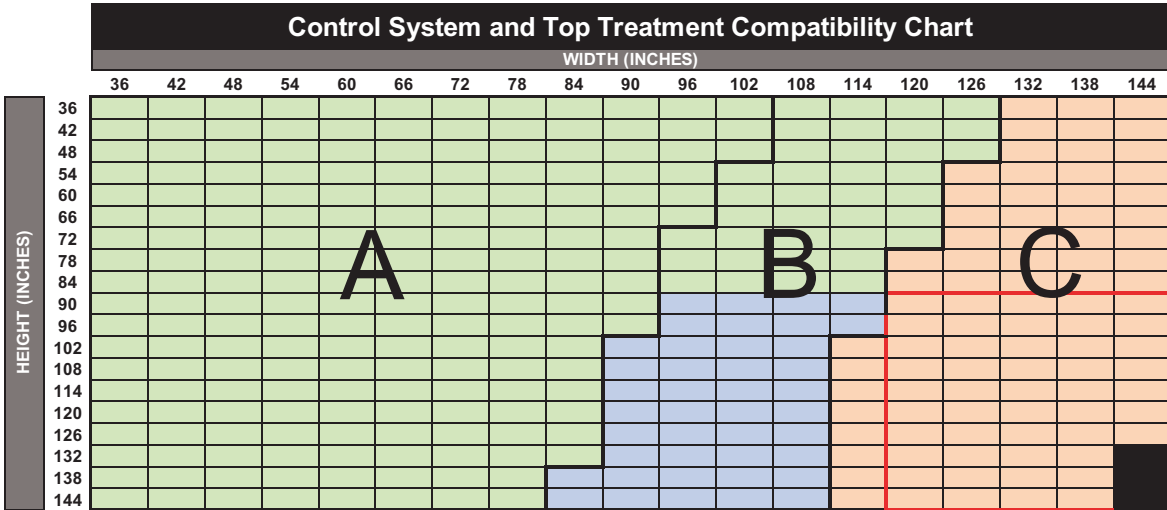

Control Systems (Minimum height for all Control Systems is 12")		Minimum Width (Single Panel)	Overall Minimum Width (2-on-1)	Specification Zone(s)*	Top Treatment
Continuous Loop Control	Continuous Loop Control (Maximum height for 12" width is 60")	12"	24"	A, B & C	All
	**Continuous Loop Control with Spring Assist	60"	NA	A, B & C	Open Roll & 4" Fascia
PowerWand	Powerwand 1.0 Li-Ion	21"	43"	A	All
	Powerwand 2.0 Li-Ion	22"	45"	A & B	(except 3" Fascia)
Lithium-ion Motors	Bliss™ 1.1 Li-Ion	21 1/2"	44"	A	All
	Bliss™ 2.0 Li-Ion	29"	59"	A & B	
	Sonessé® 28 WireFree™ RTS Li-Ion / Sonessé® 28 WireFree™ Zigbee Li-Ion	24 1/2"	50"	A	
	Sonessé® ULTRA 30 WireFree™ RTS Li-Ion	28 1/2"	58"	A & B	
DC Motors	Bliss™ 1.1 DC	16 1/2"	34"	A	All
	Bliss™ 2.0 DC	22 1/2"	46"	A & B	
	Sonessé® 28 WireFree™ RTS DC / Sonessé® 28 WireFree™ Zigbee DC	16 1/2"	34"	A	
	Sonessé® 30 RTS 24v DC	21"	NA	A & B	

**See Spring Assist Section in reference guide for details

*Not all fabrics are available in all zones

Control System and Top Treatment Compatibility Chart - High Torque Motors

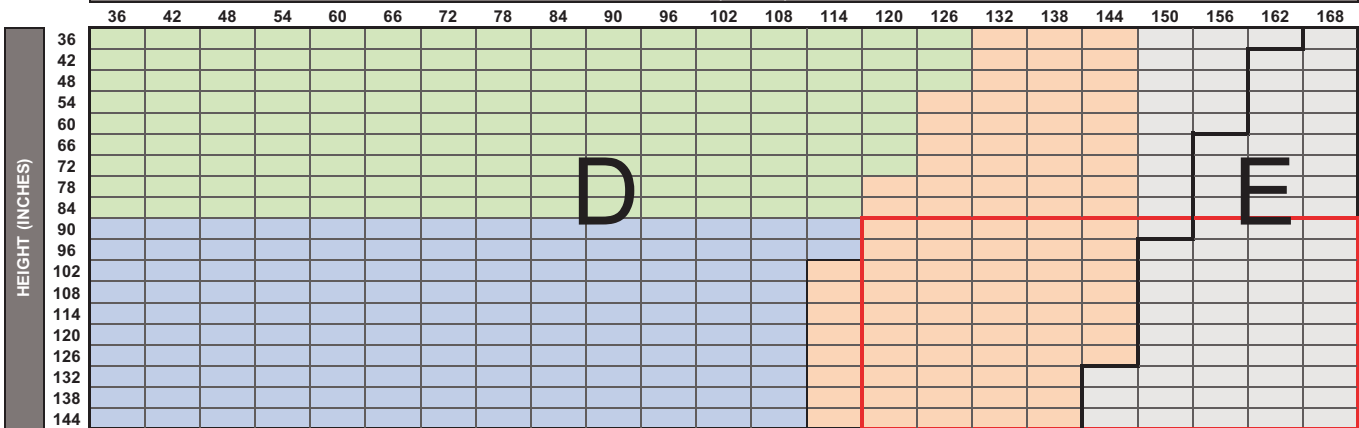

Control Systems (Minimum height for all Control Systems is 12")		Minimum Width (Single Panel)	Overall Minimum Width (2-on-1)	Specification Zone(s)*	Top Treatment
Lithium-ion Motors	Bliss™ 3.0 Li-Ion	32"	65"	D & E	All
	Sonessé® 40 WireFree™ RTS Li-Ion	31"	63"	D	
AC Motors	Bliss™ 10.0 AC	35"	NA	D & E	Open Roll, Fabric Cornice, and 4" Fascia
	Sonessé® 50 RTS AC (120V)	33"	NA	D & E	
	Sonessé® Ultra 50 AC (120V)	39"	NA	D & E	

*Not all fabrics are available in all zones

PRODUCT SIZE SPECIFICATIONS – CONTINUOUS LOOP CONTROL & AUTOMATION

Collection Code	Collection Name	Max Width Non-Railroaded ** (inches)	Max Width Railroaded (inches)	Available with Seam
AS008	3% Ecoscape Screen	118	NA	No

**To determine the maximum width for continuous Fabric Cornices, subtract 4 inches from the maximum non-railroad width.

- Railroad Fabrics (turned width for length) will have a visible seam when fabricated longer than the maximum roll width less 16".
- Red Box in spec chart indicates shade sizes Heat Sealed Hem Bar is recommended. For Continuous Loop Control, metal chain is also recommended for these sizes.

Top Treatment	Legend			
Medium Cassette				
3" Fascia				
Large Cassette				
Square Cassette				
Fabric Cornice				
4" Fascia				
Open Roll				

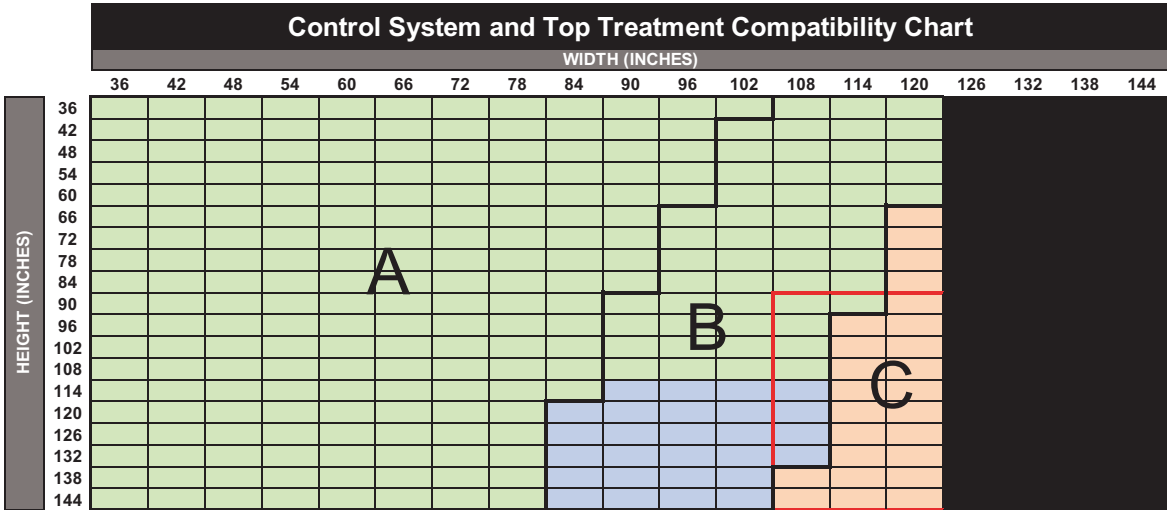

Control Systems (Minimum height for all Control Systems is 12")		Minimum Width (Single Panel)	Overall Minimum Width (2-on-1)	Specification Zone(s)*	Top Treatment
Continuous Loop Control	Continuous Loop Control (Maximum height for 12" width is 60")	12"	24"	A, B & C	All
	**Continuous Loop Control with Spring Assist	60"	NA	A, B & C	Open Roll & 4" Fascia
PowerWand	Powerwand 1.0 Li-Ion	21"	43"	A	All
	Powerwand 2.0 Li-Ion	22"	45"	A & B	(except 3" Fascia)
Lithium-ion Motors	Bliss™ 1.1 Li-Ion	21 1/2"	44"	A	All
	Bliss™ 2.0 Li-Ion	29"	59"	A & B	
	Sonesse® 28 WireFree™ RTS Li-Ion / Sonesse® 28 WireFree™ Zigbee Li-Ion	24 1/2"	50"	A	
	Sonesse® ULTRA 30 WireFree™ RTS Li-Ion	28 1/2"	58"	A & B	
DC Motors	Bliss™ 1.1 DC	16 1/2"	34"	A	All
	Bliss™ 2.0 DC	22 1/2"	46"	A & B	
	Sonesse® 28 WireFree™ RTS DC / Sonesse® 28 WireFree™ Zigbee DC	16 1/2"	34"	A	
	Sonesse® 30 RTS 24v DC	21"	NA	A & B	

**See Spring Assist Section in reference guide for details

*Not all fabrics are available in all zones

Control System and Top Treatment Compatibility Chart - High Torque Motors

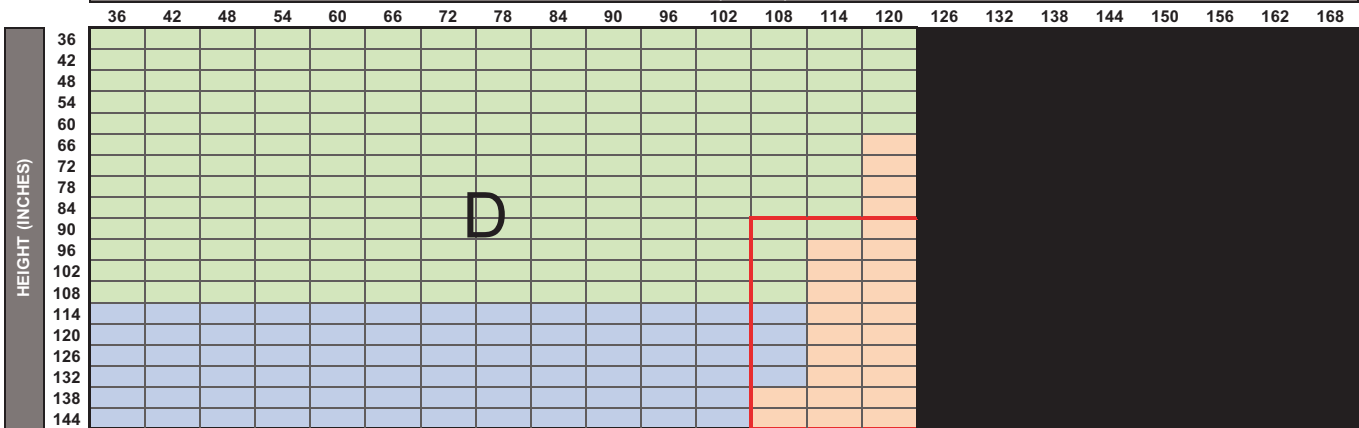

Control Systems (Minimum height for all Control Systems is 12")		Minimum Width (Single Panel)	Overall Minimum Width (2-on-1)	Specification Zone(s)*	Top Treatment
Lithium-ion Motors	Bliss™ 3.0 Li-Ion	32"	65"	D & E	All
	Sonesse® 40 WireFree™ RTS Li-Ion	31"	63"	D	
AC Motors	Bliss™ 10.0 AC	35"	NA	D & E	Open Roll, Fabric Cornice, and 4" Fascia
	Sonesse® 50 RTS AC (120V)	33"	NA	D & E	
	Sonesse® Ultra 50 AC (120V)	39"	NA	D & E	

*Not all fabrics are available in all zones

PRODUCT SIZE SPECIFICATIONS – CONTINUOUS LOOP CONTROL & AUTOMATION

Collection Code	Collection Name	Max Width Non-Railroaded ** (inches)	Max Width Railroaded (inches)	Available with Seam
AS011	3% EnduroScreen	98	168	Yes

**To determine the maximum width for continuous Fabric Cornices, subtract 4 inches from the maximum non-railroad width.

· Railroad Fabrics (turned width for length) will have a visible seam when fabricated longer than the maximum roll width less 16".
 · Red Box in spec chart indicates shade sizes Heat Sealed Hem Bar is recommended. For Continuous Loop Control, metal chain is also recommended for these sizes.

Top Treatment	Legend			
Medium Cassette	Green	Blue	Yellow	Orange
3" Fascia	Green	Blue	Yellow	Orange
Large Cassette	Green	Blue	Yellow	Orange
Square Cassette	Green	Blue	Yellow	Orange
Fabric Cornice	Green	Blue	Yellow	Orange
4" Fascia	Green	Blue	Yellow	Orange
Open Roll	Green	Blue	Yellow	Orange

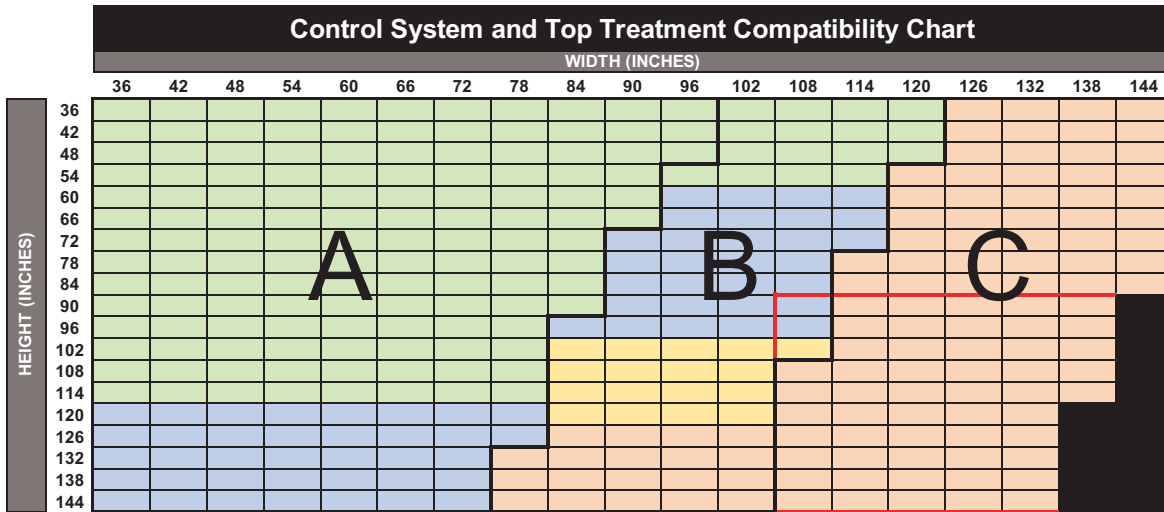

Control Systems (Minimum height for all Control Systems is 12")		Minimum Width (Single Panel)	Overall Minimum Width (2-on-1)	Specification Zone(s)*	Top Treatment
Continuous Loop Control	Continuous Loop Control (Maximum height for 12" width is 60")	12"	24"	A, B & C	All
	**Continuous Loop Control with Spring Assist	60"	NA	A, B & C	Open Roll & 4" Fascia
PowerWand	Powerwand 1.0 Li-Ion	21"	43"	A	All
	Powerwand 2.0 Li-Ion	22"	45"	A & B	(except 3" Fascia)
Lithium-ion Motors	Bliss™ 1.1 Li-Ion	21 1/2"	44"	A	All
	Bliss™ 2.0 Li-Ion	29"	59"	A & B	
	Sonesse® 28 WireFree™ RTS Li-Ion / Sonesse® 28 WireFree™ Zigbee Li-Ion	24 1/2"	50"	A	
	Sonesse® ULTRA 30 WireFree™ RTS Li-Ion	28 1/2"	58"	A & B	
DC Motors	Bliss™ 1.1 DC	16 1/2"	34"	A	All
	Bliss™ 2.0 DC	22 1/2"	46"	A & B	
	Sonesse® 28 WireFree™ RTS DC / Sonesse® 28 WireFree™ Zigbee DC	16 1/2"	34"	A	
	Sonesse® 30 RTS 24v DC	21"	NA	A & B	

**See Spring Assist Section in reference guide for details

*Not all fabrics are available in all zones

Control System and Top Treatment Compatibility Chart - High Torque Motors

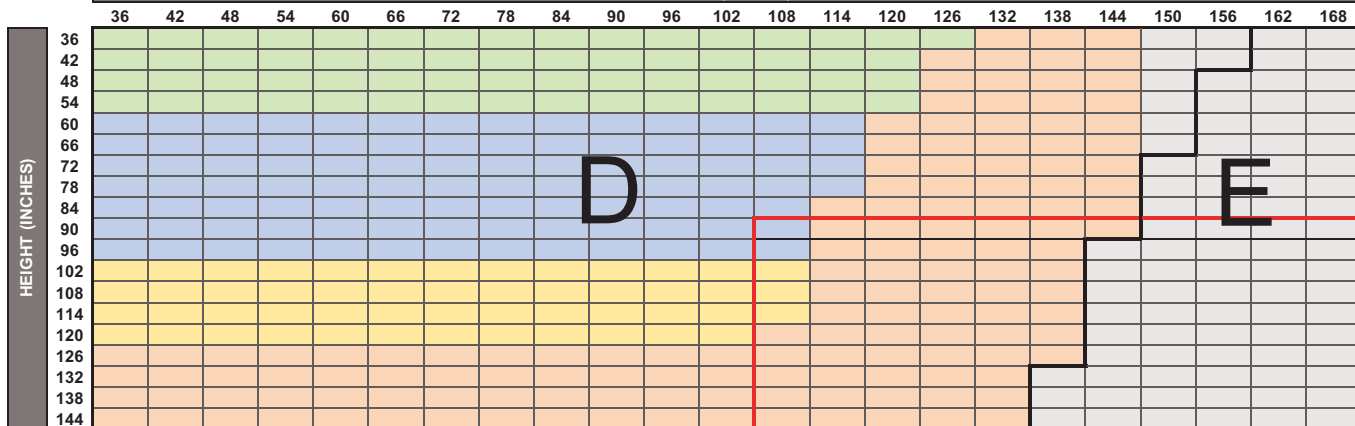

Control Systems (Minimum height for all Control Systems is 12")		Minimum Width (Single Panel)	Overall Minimum Width (2-on-1)	Specification Zone(s)*	Top Treatment
Lithium-ion Motors	Bliss™ 3.0 Li-Ion	32"	65"	D & E	All
	Sonesse® 40 WireFree™ RTS Li-Ion	31"	63"	D	
AC Motors	Bliss™ 10.0 AC	35"	NA	D & E	Open Roll, Fabric Cornice, and 4" Fascia
	Sonesse® 50 RTS AC (120V)	33"	NA	D & E	
	Sonesse® Ultra 50 AC (120V)	39"	NA	D & E	

*Not all fabrics are available in all zones

PRODUCT SIZE SPECIFICATIONS – CONTINUOUS LOOP CONTROL & AUTOMATION

Collection Code	Collection Name	Max Width Non-Railroaded ** (inches)	Max Width Railroaded (inches)	Available with Seam
AS014	3% Environs Screen	118	168	No

Top Treatment	Legend			
Medium Cassette				
3" Fascia				
Large Cassette				
Square Cassette				
Fabric Cornice				
4" Fascia				
Open Roll				

**To determine the maximum width for continuous Fabric Cornices, subtract 4 inches from the maximum non-railroad width. Maximum height is 102" when railroaded

· Railroad Fabrics (turned width for length) will have a visible seam when fabricated longer than the maximum roll width less 16".
 · The **Red Box** in the spec chart indicates shade sizes metal chain is recommended for Continuous Loop Control.

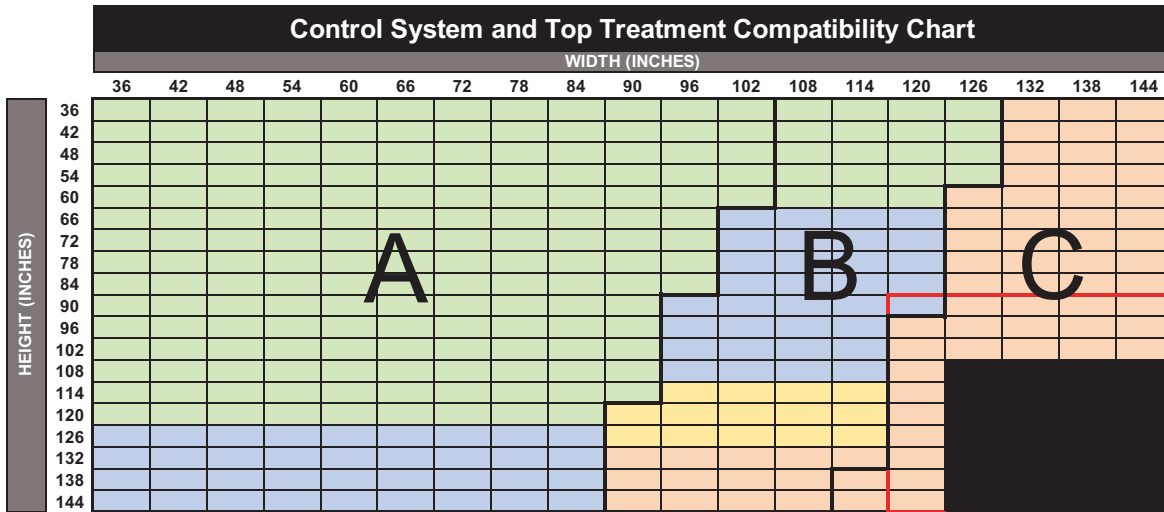

Control Systems (Minimum height for all Control Systems is 12")		Minimum Width (Single Panel)	Overall Minimum Width (2-on-1)	Specification Zone(s)*	Top Treatment
Continuous Loop Control	Continuous Loop Control (Maximum height for 12" width is 60")	12"	24"	A, B & C	All
	**Continuous Loop Control with Spring Assist	60"	NA	A, B & C	Open Roll & 4" Fascia
PowerWand	Powerwand 1.0 Li-Ion	21"	43"	A	All
	Powerwand 2.0 Li-Ion	22"	45"	A & B	(except 3" Fascia)
Lithium-ion Motors	Bliss™ 1.1 Li-Ion	21 1/2"	44"	A	All
	Bliss™ 2.0 Li-Ion	29"	59"	A & B	
	Sonessé® 28 WireFree™ RTS Li-Ion / Sonessé® 28 WireFree™ Zigbee Li-Ion	24 1/2"	50"	A	
	Sonessé® ULTRA 30 WireFree™ RTS Li-Ion	28 1/2"	58"	A & B	
DC Motors	Bliss™ 1.1 DC	16 1/2"	34"	A	All
	Bliss™ 2.0 DC	22 1/2"	46"	A & B	
	Sonessé® 28 WireFree™ RTS DC / Sonessé® 28 WireFree™ Zigbee DC	16 1/2"	34"	A	
	Sonessé® 30 RTS 24v DC	21"	NA	A & B	

**See Spring Assist Section in reference guide for details

*Not all fabrics are available in all zones

Control System and Top Treatment Compatibility Chart - High Torque Motors

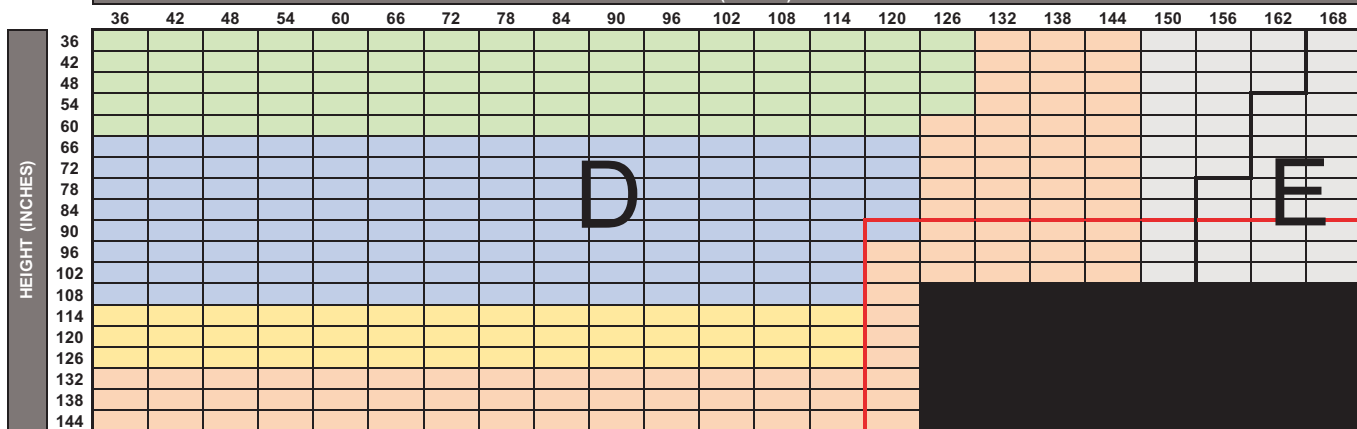

Control Systems (Minimum height for all Control Systems is 12")		Minimum Width (Single Panel)	Overall Minimum Width (2-on-1)	Specification Zone(s)*	Top Treatment
Lithium-ion Motors	Bliss™ 3.0 Li-Ion	32"	65"	D & E	All
	Sonessé® 40 WireFree™ RTS Li-Ion	31"	63"	D	
AC Motors	Bliss™ 10.0 AC	35"	NA	D & E	Open Roll, Fabric Cornice, and 4" Fascia
	Sonessé® 50 RTS AC (120V)	33"	NA	D & E	
	Sonessé® Ultra 50 AC (120V)	39"	NA	D & E	

*Not all fabrics are available in all zones

PRODUCT SIZE SPECIFICATIONS – CONTINUOUS LOOP CONTROL & AUTOMATION

Collection Code	Collection Name	Max Width Non-Railroaded ** (inches)	Max Width Railroaded (inches)	Available with Seam
RS24	3% Nordic Screen Plus	118	168	Yes
AS028	3% Bamboo	113	NA	No
AS024	3% Bellflower	113	NA	No
AS026	3% Delhi	113	NA	No
AS027	3% Lady Amherst	113	NA	No
AS029	3% Sovereign	113	NA	No

Top Treatment	Legend				
Medium Cassette	Green	Blue	Yellow	Orange	Grey
3" Fascia	Green	Blue	Yellow	Orange	Grey
Large Cassette	Green	Blue	Yellow	Orange	Grey
Square Cassette	Green	Blue	Yellow	Orange	Grey
Fabric Cornice	Green	Blue	Yellow	Orange	Grey
4" Fascia	Green	Blue	Yellow	Orange	Grey
Open Roll	Green	Blue	Yellow	Orange	Grey

**To determine the maximum width for continuous Fabric Cornices, subtract 4 inches from the maximum non-railroad width.

· Railroad Fabrics (turned width for length) will have a visible seam when fabricated longer than the maximum roll width less 16".

· Red Box in spec chart indicates shade sizes Heat Sealed Hem Bar is recommended. For Continuous Loop Control, metal chain is also recommended for these sizes.

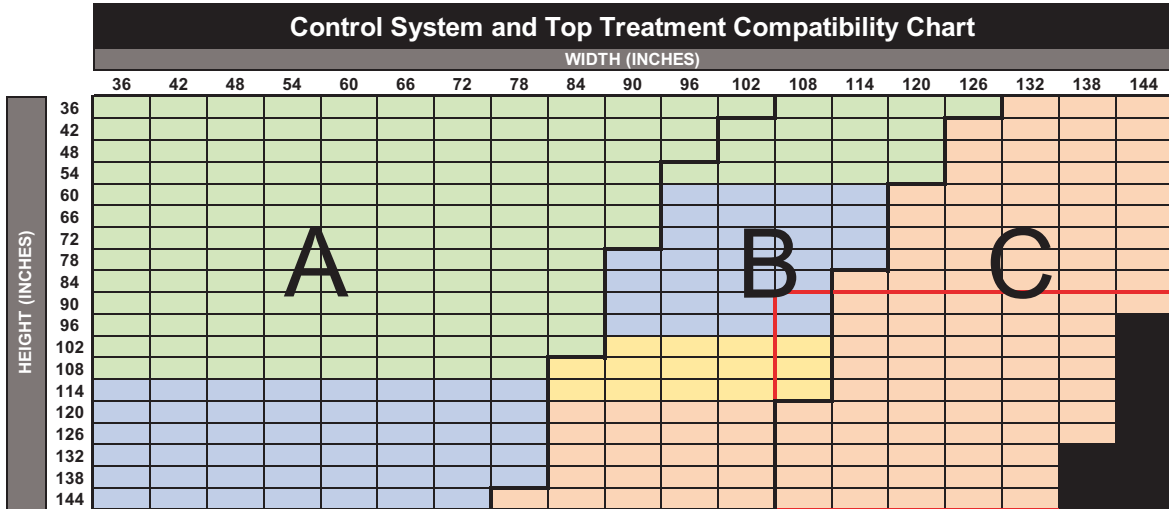

Control Systems (Minimum height for all Control Systems is 12")		Minimum Width (Single Panel)	Overall Minimum Width (2-on-1)	Specification Zone(s)*	Top Treatment
Continuous Loop Control	Continuous Loop Control (Maximum height for 12" width is 60")	12"	24"	A, B & C	All
	**Continuous Loop Control with Spring Assist	60"	NA	A, B & C	Open Roll & 4" Fascia
PowerWand	Powerwand 1.0 Li-Ion	21"	43"	A	All
	Powerwand 2.0 Li-Ion	22"	45"	A & B	(except 3" Fascia)
Lithium-ion Motors	Bliss™ 1.1 Li-Ion	21 1/2"	44"	A	All
	Bliss™ 2.0 Li-Ion	29"	59"	A & B	
	Sonesse® 28 WireFree™ RTS Li-Ion / Sonesse® 28 WireFree™ Zigbee Li-Ion	24 1/2"	50"	A	
	Sonesse® ULTRA 30 WireFree™ RTS Li-Ion	28 1/2"	58"	A & B	
DC Motors	Bliss™ 1.1 DC	16 1/2"	34"	A	All
	Bliss™ 2.0 DC	22 1/2"	46"	A & B	
	Sonesse® 28 WireFree™ RTS DC / Sonesse® 28 WireFree™ Zigbee DC	16 1/2"	34"	A	
	Sonesse® 30 RTS 24v DC	21"	NA	A & B	

**See Spring Assist Section in reference guide for details

*Not all fabrics are available in all zones

Control System and Top Treatment Compatibility Chart - High Torque Motors

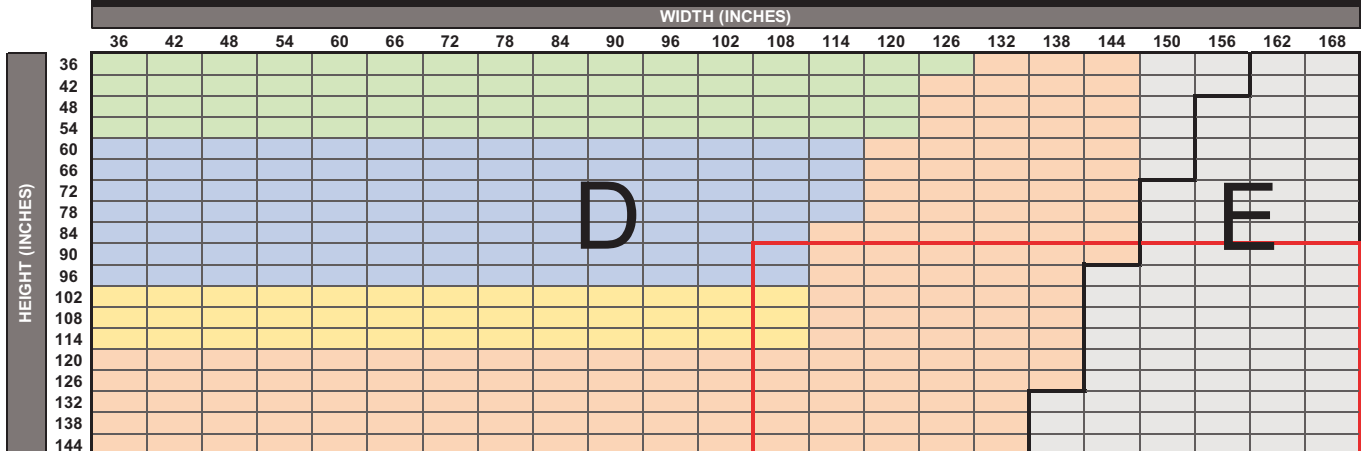

Control Systems (Minimum height for all Control Systems is 12")		Minimum Width (Single Panel)	Overall Minimum Width (2-on-1)	Specification Zone(s)*	Top Treatment
Lithium-ion Motors	Bliss™ 3.0 Li-Ion	32"	65"	D & E	All
	Sonesse® 40 WireFree™ RTS Li-Ion	31"	63"	D	
AC Motors	Bliss™ 10.0 AC	35"	NA	D & E	Open Roll, Fabric Cornice, and 4" Fascia
	Sonesse® 50 RTS AC (120V)	33"	NA	D & E	
	Sonesse® Ultra 50 AC (120V)	39"	NA	D & E	

*Not all fabrics are available in all zones

PRODUCT SIZE SPECIFICATIONS – CONTINUOUS LOOP CONTROL & AUTOMATION

Collection Code	Collection Name	Max Width Non-Railroaded ** (inches)	Max Width Railroaded (inches)	Available with Seam
R06	3% Sheerweave 2410	126	168	Yes

**To determine the maximum width for continuous Fabric Cornices, subtract 4 inches from the maximum non-railroad width.

- Railroad Fabrics (turned width for length) will have a visible seam when fabricated longer than the maximum roll width less 16".
- Red Box in spec chart indicates shade sizes Heat Sealed Hem Bar is recommended. For Continuous Loop Control, metal chain is also recommended for these sizes.

Top Treatment	Legend			
Medium Cassette				
3" Fascia				
Large Cassette				
Square Cassette				
Fabric Cornice				
4" Fascia				
Open Roll				

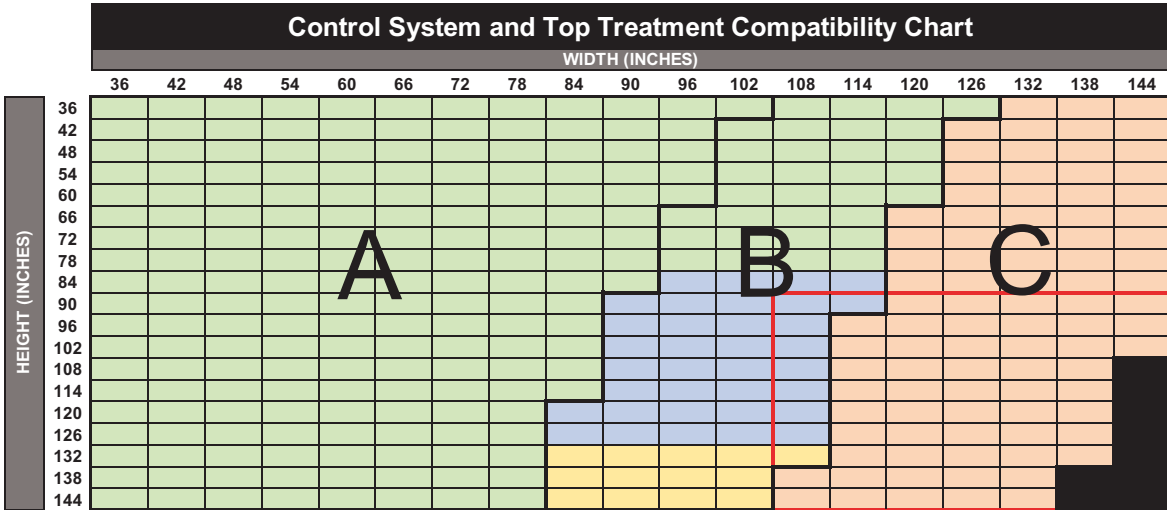

Control Systems (Minimum height for all Control Systems is 12")		Minimum Width (Single Panel)	Overall Minimum Width (2-on-1)	Specification Zone(s)*	Top Treatment
Continuous Loop Control	Continuous Loop Control (Maximum height for 12" width is 60")	12"	24"	A, B & C	All
	**Continuous Loop Control with Spring Assist	60"	NA	A, B & C	Open Roll & 4" Fascia
PowerWand	Powerwand 1.0 Li-Ion	21"	43"	A	All
	Powerwand 2.0 Li-Ion	22"	45"	A & B	(except 3" Fascia)
Lithium-ion Motors	Bliss™ 1.1 Li-Ion	21 1/2"	44"	A	All
	Bliss™ 2.0 Li-Ion	29"	59"	A & B	
	Sonesse® 28 WireFree™ RTS Li-Ion / Sonesse® 28 WireFree™ Zigbee Li-Ion	24 1/2"	50"	A	
	Sonesse® ULTRA 30 WireFree™ RTS Li-Ion	28 1/2"	58"	A & B	
DC Motors	Bliss™ 1.1 DC	16 1/2"	34"	A	All
	Bliss™ 2.0 DC	22 1/2"	46"	A & B	
	Sonesse® 28 WireFree™ RTS DC / Sonesse® 28 WireFree™ Zigbee DC	16 1/2"	34"	A	
	Sonesse® 30 RTS 24v DC	21"	NA	A & B	

**See Spring Assist Section in reference guide for details

*Not all fabrics are available in all zones

Control System and Top Treatment Compatibility Chart - High Torque Motors

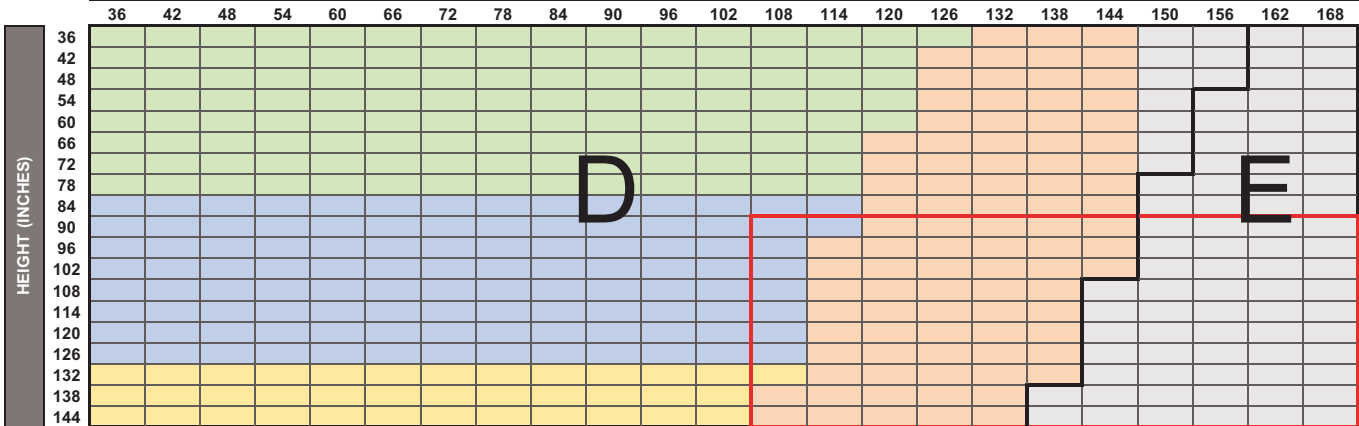

Control Systems (Minimum height for all Control Systems is 12")		Minimum Width (Single Panel)	Overall Minimum Width (2-on-1)	Specification Zone(s)*	Top Treatment
Lithium-ion Motors	Bliss™ 3.0 Li-Ion	32"	65"	D & E	All
	Sonesse® 40 WireFree™ RTS Li-Ion	31"	63"	D	
AC Motors	Bliss™ 10.0 AC	35"	NA	D & E	Open Roll, Fabric Cornice, and 4" Fascia
	Sonesse® 50 RTS AC (120V)	33"	NA	D & E	
	Sonesse® Ultra 50 AC (120V)	39"	NA	D & E	

*Not all fabrics are available in all zones

PRODUCT SIZE SPECIFICATIONS – CONTINUOUS LOOP CONTROL & AUTOMATION

Collection Code	Collection Name	Max Width Non-Railroaded ** (inches)	Max Width Railroaded (inches)	Available with Seam
P2703	3% Sheerweave 2703	126	168	Yes

**To determine the maximum width for continuous Fabric Cornices, subtract 4 inches from the maximum non-railroad width. Maximum height is 168" (only for Open Roll on 3 1/4" tube)

- Railroad Fabrics (turned width for length) will have a visible seam when fabricated longer than the maximum roll width less 16".
- Red Box in spec chart indicates shade sizes Heat Sealed Hem Bar is recommended. For Continuous Loop Control, metal chain is also recommended for these sizes.

Top Treatment	Legend			
Medium Cassette				
3" Fascia				
Large Cassette				
Square Cassette				
Fabric Cornice				
4" Fascia				
Open Roll				

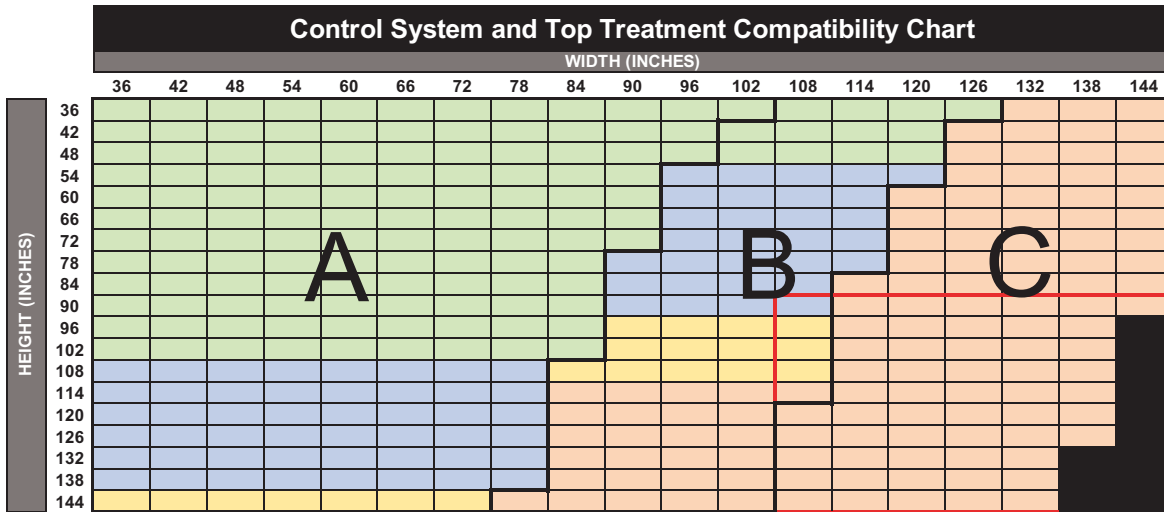

Control Systems (Minimum height for all Control Systems is 12")		Minimum Width (Single Panel)	Overall Minimum Width (2-on-1)	Specification Zone(s)*	Top Treatment
Continuous Loop Control	Continuous Loop Control (Maximum height for 12" width is 60")	12"	24"	A, B & C	All
	**Continuous Loop Control with Spring Assist	60"	NA	A, B & C	Open Roll & 4" Fascia
PowerWand	Powerwand 1.0 Li-Ion	21"	43"	A	All
	Powerwand 2.0 Li-Ion	22"	45"	A & B	(except 3" Fascia)
Lithium-ion Motors	Bliss™ 1.1 Li-Ion	21 1/2"	44"	A	All
	Bliss™ 2.0 Li-Ion	29"	59"	A & B	
	Sonesse® 28 WireFree™ RTS Li-Ion / Sonesse® 28 WireFree™ Zigbee Li-Ion	24 1/2"	50"	A	
	Sonesse® ULTRA 30 WireFree™ RTS Li-Ion	28 1/2"	58"	A & B	
DC Motors	Bliss™ 1.1 DC	16 1/2"	34"	A	All
	Bliss™ 2.0 DC	22 1/2"	46"	A & B	
	Sonesse® 28 WireFree™ RTS DC / Sonesse® 28 WireFree™ Zigbee DC	16 1/2"	34"	A	
	Sonesse® 30 RTS 24v DC	21"	NA	A & B	

**See Spring Assist Section in reference guide for details

*Not all fabrics are available in all zones

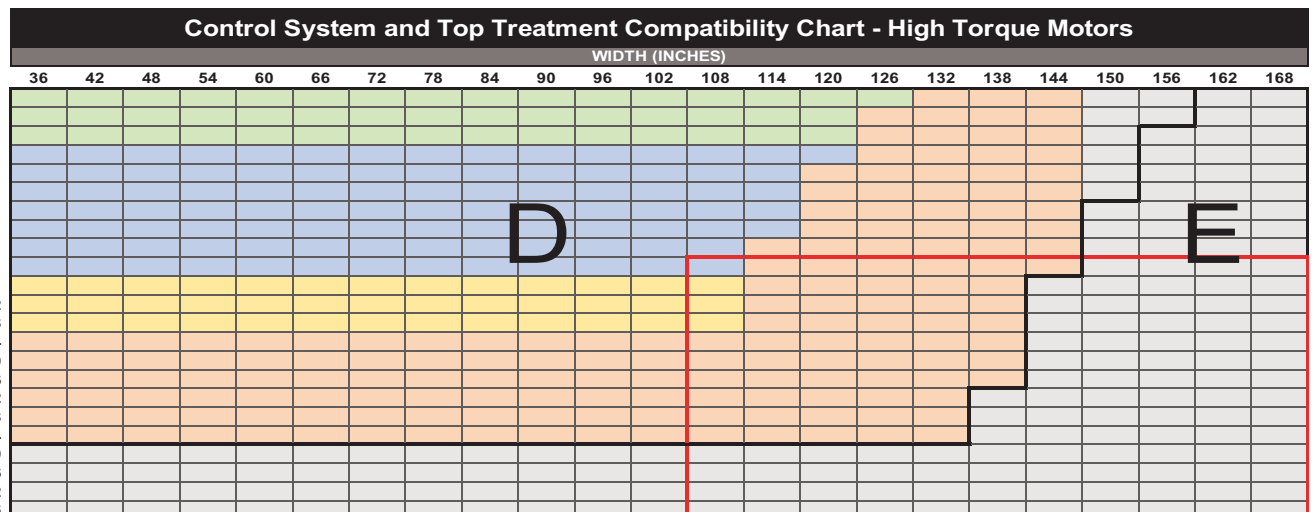

Control Systems (Minimum height for all Control Systems is 12")		Minimum Width (Single Panel)	Overall Minimum Width (2-on-1)	Specification Zone(s)*	Top Treatment
Lithium-ion Motors	Bliss™ 3.0 Li-Ion	32"	65"	D & E	All
	Sonesse® 40 WireFree™ RTS Li-Ion	31"	63"	D	
AC Motors	Bliss™ 10.0 AC	35"	NA	D & E	Open Roll, Fabric Cornice, and 4" Fascia
	Sonesse® 50 RTS AC (120V)	33"	NA	D & E	
	Sonesse® Ultra 50 AC (120V)	39"	NA	D & E	

*Not all fabrics are available in all zones

PRODUCT SIZE SPECIFICATIONS – CONTINUOUS LOOP CONTROL & AUTOMATION

Collection Code	Collection Name	Max Width Non-Railroaded ** (inches)	Max Width Railroaded (inches)	Available with Seam
RS2	3% Sheerweave 4400	126	168***	Yes

**To determine the maximum width for continuous Fabric Cornices, subtract 4 inches from the maximum non-railroad width. Maximum height is 168" (only for Open Roll on 3 1/4" tube)

· Railroad Fabrics (turned width for length) will have a visible seam when fabricated longer than the maximum roll width less 16".
 · Red Box in spec chart indicates shade sizes Heat Sealed Hem Bar is recommended. For Continuous Loop Control, metal chain is also recommended for these sizes.

Top Treatment	Legend			
Medium Cassette	Green	Blue	Yellow	Orange
3" Fascia	Green	Blue	Yellow	Orange
Large Cassette	Green	Blue	Yellow	Orange
Square Cassette	Green	Blue	Yellow	Orange
Fabric Cornice	Green	Blue	Yellow	Orange
4" Fascia	Green	Blue	Yellow	Orange
Open Roll	Green	Blue	Yellow	Orange

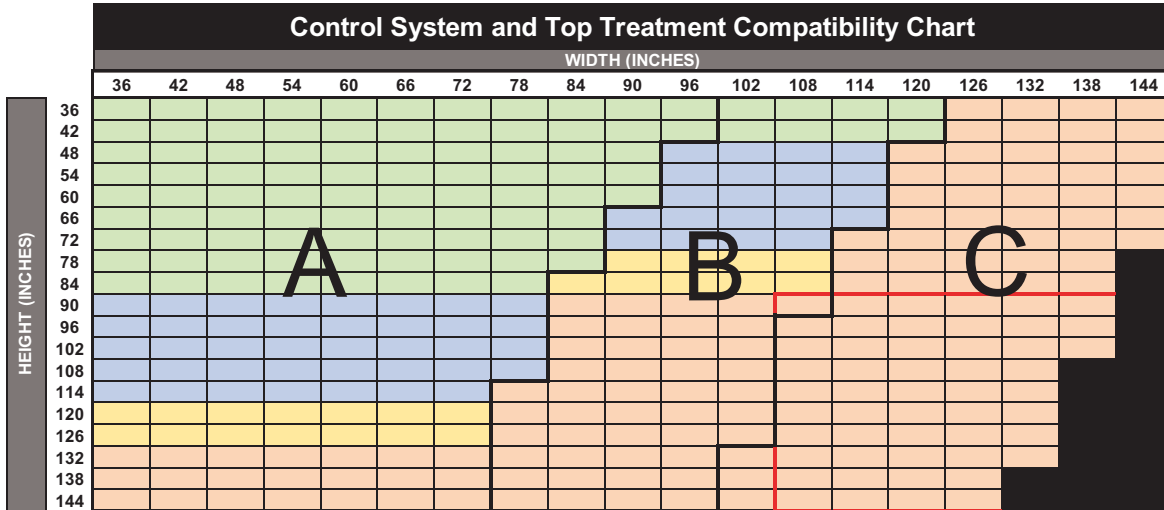

Control Systems (Minimum height for all Control Systems is 12")		Minimum Width (Single Panel)	Overall Minimum Width (2-on-1)	Specification Zone(s)*	Top Treatment
Continuous Loop Control	Continuous Loop Control (Maximum height for 12" width is 60")	12"	24"	A, B & C	All
	**Continuous Loop Control with Spring Assist	60"	NA	A, B & C	Open Roll & 4" Fascia
PowerWand	Powerwand 1.0 Li-Ion	21"	43"	A	All
	Powerwand 2.0 Li-Ion	22"	45"	A & B	(except 3" Fascia)
Lithium-ion Motors	Bliss™ 1.1 Li-Ion	21 1/2"	44"	A	All
	Bliss™ 2.0 Li-Ion	29"	59"	A & B	
	Sonesse® 28 WireFree™ RTS Li-Ion / Sonesse® 28 WireFree™ Zigbee Li-Ion	24 1/2"	50"	A	
	Sonesse® ULTRA 30 WireFree™ RTS Li-Ion	28 1/2"	58"	A & B	
DC Motors	Bliss™ 1.1 DC	16 1/2"	34"	A	All
	Bliss™ 2.0 DC	22 1/2"	46"	A & B	
	Sonesse® 28 WireFree™ RTS DC / Sonesse® 28 WireFree™ Zigbee DC	16 1/2"	34"	A	
	Sonesse® 30 RTS 24v DC	21"	NA	A & B	

**See Spring Assist Section in reference guide for details

*Not all fabrics are available in all zones

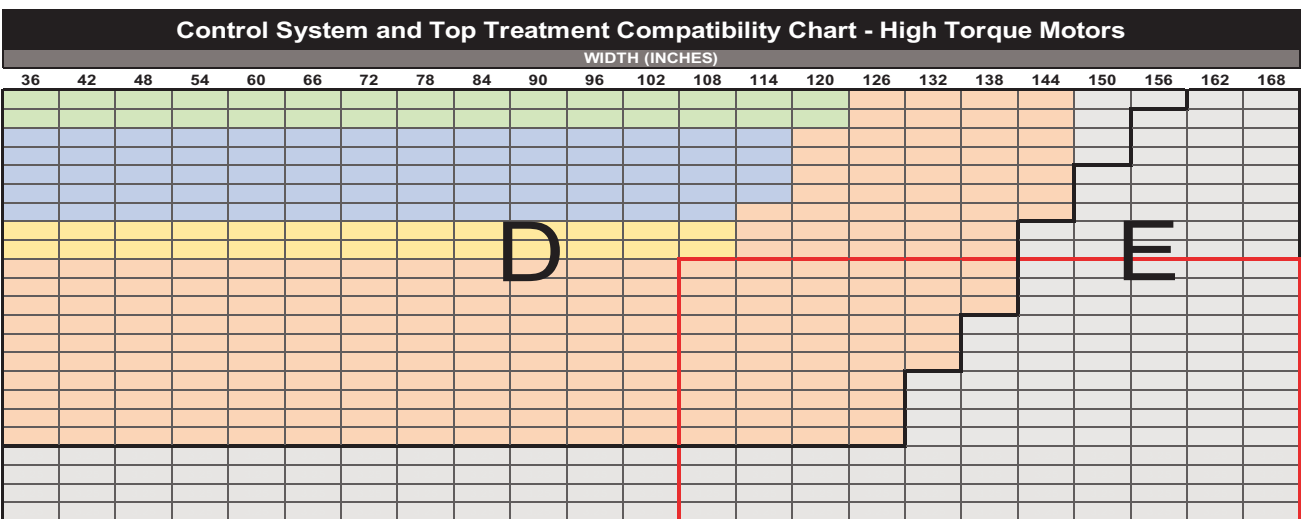

Control Systems (Minimum height for all Control Systems is 12")		Minimum Width (Single Panel)	Overall Minimum Width (2-on-1)	Specification Zone(s)*	Top Treatment
Lithium-ion Motors	Bliss™ 3.0 Li-Ion	32"	65"	D & E	All
	Sonesse® 40 WireFree™ RTS Li-Ion	31"	63"	D	
AC Motors	Bliss™ 10.0 AC	35"	NA	D & E	Open Roll, Fabric Cornice, and 4" Fascia
	Sonesse® 50 RTS AC (120V)	33"	NA	D & E	
	Sonesse® Ultra 50 AC (120V)	39"	NA	D & E	

*Not all fabrics are available in all zones

PRODUCT SIZE SPECIFICATIONS – CONTINUOUS LOOP CONTROL & AUTOMATION

Collection Code	Collection Name	Max Width Non-Railroaded ** (inches)	Max Width Railroaded (inches)	Available with Seam
P4600	3% Sheerweave 4600	98	168	Yes

**To determine the maximum width for continuous Fabric Cornices, subtract 4 inches from the maximum non-railroad width.

· Railroad Fabrics (turned width for length) will have a visible seam when fabricated longer than the maximum roll width less 16".
 · Red Box in spec chart indicates shade sizes Heat Sealed Hem Bar is recommended. For Continuous Loop Control, metal chain is also recommended for these sizes.

Top Treatment	Legend			
Medium Cassette	Green	Blue	Yellow	Orange
3" Fascia	Green	Blue	Yellow	Orange
Large Cassette	Green	Blue	Yellow	Orange
Square Cassette	Green	Blue	Yellow	Orange
Fabric Cornice	Green	Blue	Yellow	Orange
4" Fascia	Green	Blue	Yellow	Orange
Open Roll	Green	Blue	Yellow	Orange

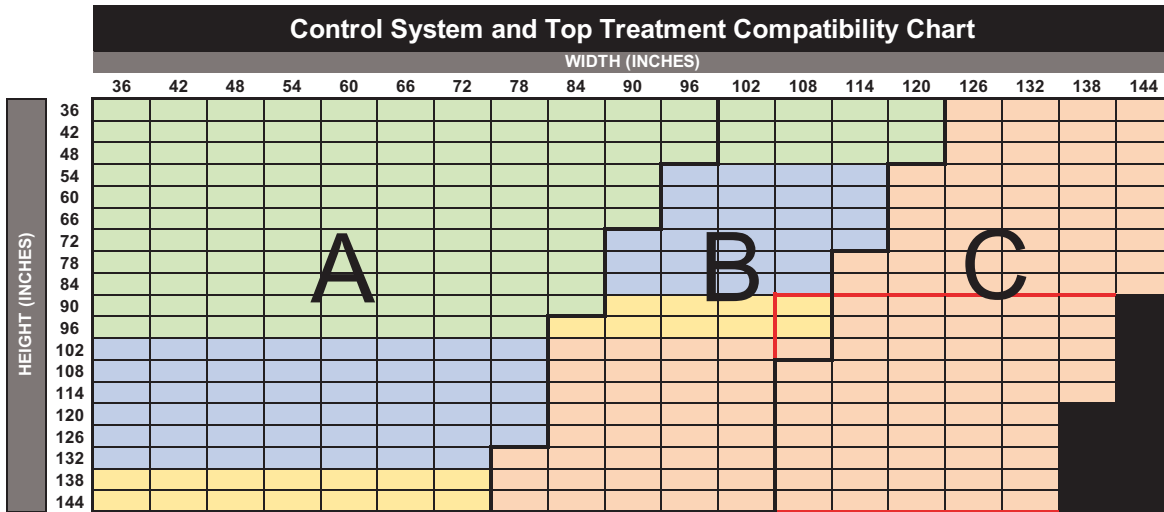

Control Systems (Minimum height for all Control Systems is 12")		Minimum Width (Single Panel)	Overall Minimum Width (2-on-1)	Specification Zone(s)*	Top Treatment
Continuous Loop Control	Continuous Loop Control (Maximum height for 12" width is 60")	12"	24"	A, B & C	All
	**Continuous Loop Control with Spring Assist	60"	NA	A, B & C	Open Roll & 4" Fascia
PowerWand	Powerwand 1.0 Li-Ion	21"	43"	A	All
	Powerwand 2.0 Li-Ion	22"	45"	A & B	(except 3" Fascia)
Lithium-ion Motors	Bliss™ 1.1 Li-Ion	21 1/2"	44"	A	All
	Bliss™ 2.0 Li-Ion	29"	59"	A & B	
	Sonesse® 28 WireFree™ RTS Li-Ion / Sonesse® 28 WireFree™ Zigbee Li-Ion	24 1/2"	50"	A	
	Sonesse® ULTRA 30 WireFree™ RTS Li-Ion	28 1/2"	58"	A & B	
DC Motors	Bliss™ 1.1 DC	16 1/2"	34"	A	All
	Bliss™ 2.0 DC	22 1/2"	46"	A & B	
	Sonesse® 28 WireFree™ RTS DC / Sonesse® 28 WireFree™ Zigbee DC	16 1/2"	34"	A	
	Sonesse® 30 RTS 24v DC	21"	NA	A & B	

**See Spring Assist Section in reference guide for details

*Not all fabrics are available in all zones

Control System and Top Treatment Compatibility Chart - High Torque Motors

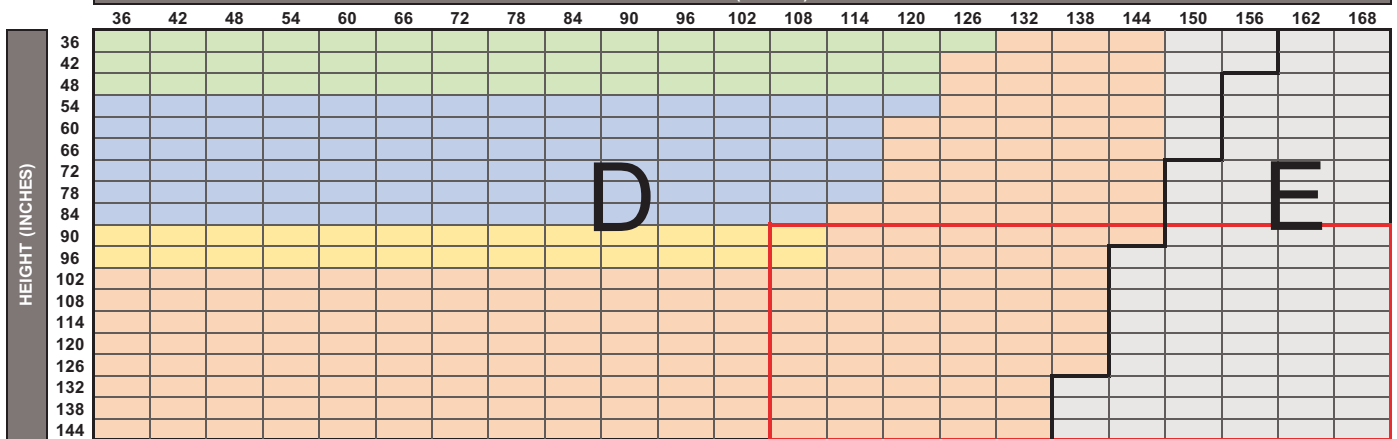

Control Systems (Minimum height for all Control Systems is 12")		Minimum Width (Single Panel)	Overall Minimum Width (2-on-1)	Specification Zone(s)*	Top Treatment
Lithium-ion Motors	Bliss™ 3.0 Li-Ion	32"	65"	D & E	All
	Sonesse® 40 WireFree™ RTS Li-Ion	31"	63"	D	
AC Motors	Bliss™ 10.0 AC	35"	NA	D & E	Open Roll, Fabric Cornice, and 4" Fascia
	Sonesse® 50 RTS AC (120V)	33"	NA	D & E	
	Sonesse® Ultra 50 AC (120V)	39"	NA	D & E	

*Not all fabrics are available in all zones

PRODUCT SIZE SPECIFICATIONS – CONTINUOUS LOOP CONTROL & AUTOMATION

Collection Code	Collection Name	Max Width Non-Railroaded ** (inches)	Max Width Railroaded (inches)	Available with Seam
P4903	3% Sheerweave 4903	98	168	Yes

**To determine the maximum width for continuous Fabric Cornices, subtract 4 inches from the maximum non-railroad width.

- Railroad Fabrics (turned width for length) will have a visible seam when fabricated longer than the maximum roll width less 16".
- Red Box in spec chart indicates shade sizes Heat Sealed Hem Bar is recommended. For Continuous Loop Control, metal chain is also recommended for these sizes.

Top Treatment	Legend			
Medium Cassette				
3" Fascia				
Large Cassette				
Square Cassette				
Fabric Cornice				
4" Fascia				
Open Roll				

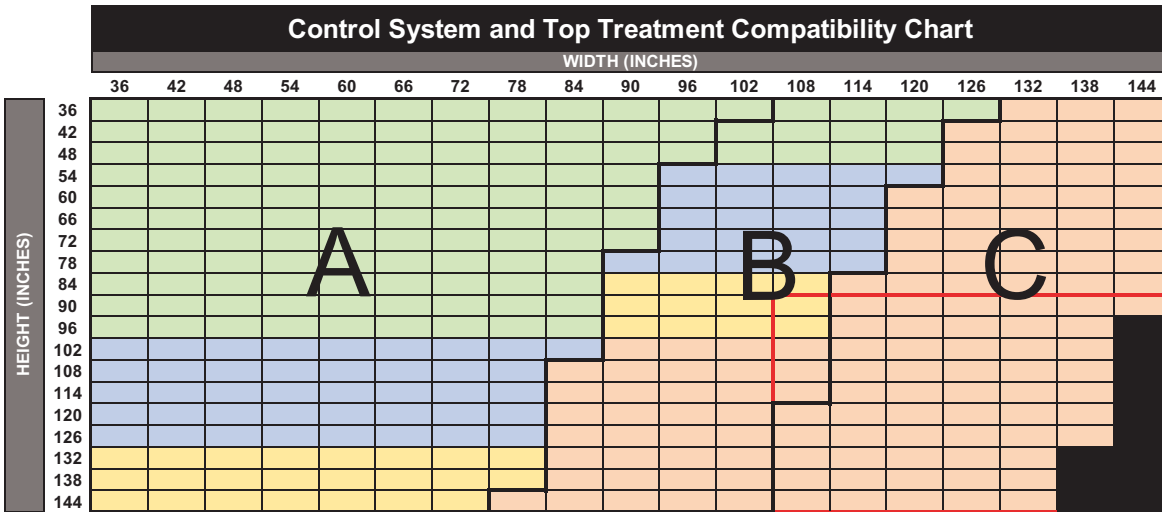

Control Systems (Minimum height for all Control Systems is 12")		Minimum Width (Single Panel)	Overall Minimum Width (2-on-1)	Specification Zone(s)*	Top Treatment
Continuous Loop Control	Continuous Loop Control (Maximum height for 12" width is 60")	12"	24"	A, B & C	All
	**Continuous Loop Control with Spring Assist	60"	NA	A, B & C	Open Roll & 4" Fascia
PowerWand	Powerwand 1.0 Li-Ion	21"	43"	A	All
	Powerwand 2.0 Li-Ion	22"	45"	A & B	(except 3" Fascia)
Lithium-ion Motors	Bliss™ 1.1 Li-Ion	21 1/2"	44"	A	All
	Bliss™ 2.0 Li-Ion	29"	59"	A & B	
	Sonesse® 28 WireFree™ RTS Li-Ion / Sonesse® 28 WireFree™ Zigbee Li-Ion	24 1/2"	50"	A	
	Sonesse® ULTRA 30 WireFree™ RTS Li-Ion	28 1/2"	58"	A & B	
DC Motors	Bliss™ 1.1 DC	16 1/2"	34"	A	All
	Bliss™ 2.0 DC	22 1/2"	46"	A & B	
	Sonesse® 28 WireFree™ RTS DC / Sonesse® 28 WireFree™ Zigbee DC	16 1/2"	34"	A	
	Sonesse® 30 RTS 24v DC	21"	NA	A & B	

**See Spring Assist Section in reference guide for details

*Not all fabrics are available in all zones

Control System and Top Treatment Compatibility Chart - High Torque Motors

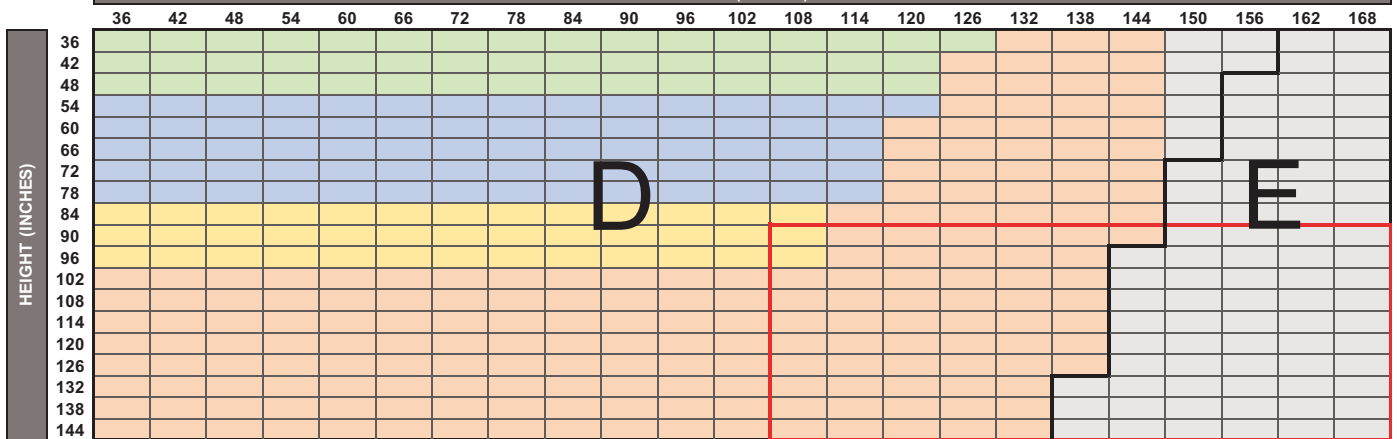

Control Systems (Minimum height for all Control Systems is 12")		Minimum Width (Single Panel)	Overall Minimum Width (2-on-1)	Specification Zone(s)*	Top Treatment
Lithium-ion Motors	Bliss™ 3.0 Li-Ion	32"	65"	D & E	All
	Sonesse® 40 WireFree™ RTS Li-Ion	31"	63"	D	
AC Motors	Bliss™ 10.0 AC	35"	NA	D & E	Open Roll, Fabric Cornice, and 4" Fascia
	Sonesse® 50 RTS AC (120V)	33"	NA	D & E	
	Sonesse® Ultra 50 AC (120V)	39"	NA	D & E	

*Not all fabrics are available in all zones

PRODUCT SIZE SPECIFICATIONS – CONTINUOUS LOOP CONTROL & AUTOMATION

Collection Code	Collection Name	Max Width Non-Railroaded ** (inches)	Max Width Railroaded (inches)	Available with Seam
R07	3% Sheerweave 5000 (R89)	98	168	Yes

Top Treatment	Legend			
Medium Cassette				
3" Fascia				
Large Cassette				
Square Cassette				
Fabric Cornice				
4" Fascia				
Open Roll				

**To determine the maximum width for continuous Fabric Cornices, subtract 4 inches from the maximum non-railroad width.

Maximum height with Spring Assist on 4" Fascia is 102"

Not available with fabric-wrapped Square Cassette

· Railroad Fabrics (turned width for length) will have a visible seam when fabricated longer than the maximum roll width less 16".

· Red Box in spec chart indicates shade sizes Heat Sealed Hem Bar is recommended. For Continuous Loop Control, metal chain is also recommended for these sizes.

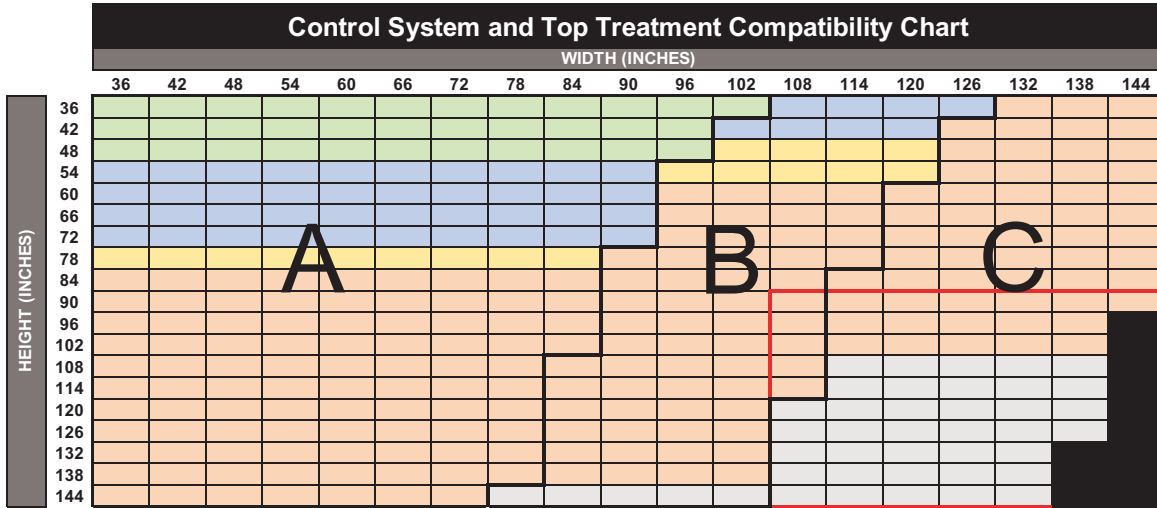

Control Systems (Minimum height for all Control Systems is 12")		Minimum Width (Single Panel)	Overall Minimum Width (2-on-1)	Specification Zone(s)*	Top Treatment
Continuous Loop Control	Continuous Loop Control (Maximum height for 12" width is 60")	12"	24"	A, B & C	All
	**Continuous Loop Control with Spring Assist	60"	NA	A, B & C	Open Roll & 4" Fascia
PowerWand	Powerwand 1.0 Li-Ion	21"	43"	A	All
	Powerwand 2.0 Li-Ion	22"	45"	A & B	(except 3" Fascia)
Lithium-ion Motors	Bliss™ 1.1 Li-Ion	21 1/2"	44"	A	All
	Bliss™ 2.0 Li-Ion	29"	59"	A & B	
	Sonessé® 28 WireFree™ RTS Li-Ion / Sonessé® 28 WireFree™ Zigbee Li-Ion	24 1/2"	50"	A	
	Sonessé® ULTRA 30 WireFree™ RTS Li-Ion	28 1/2"	58"	A & B	
DC Motors	Bliss™ 1.1 DC	16 1/2"	34"	A	All
	Bliss™ 2.0 DC	22 1/2"	46"	A & B	
	Sonessé® 28 WireFree™ RTS DC / Sonessé® 28 WireFree™ Zigbee DC	16 1/2"	34"	A	
	Sonessé® 30 RTS 24v DC	21"	NA	A & B	

**See Spring Assist Section in reference guide for details

*Not all fabrics are available in all zones

Control System and Top Treatment Compatibility Chart - High Torque Motors

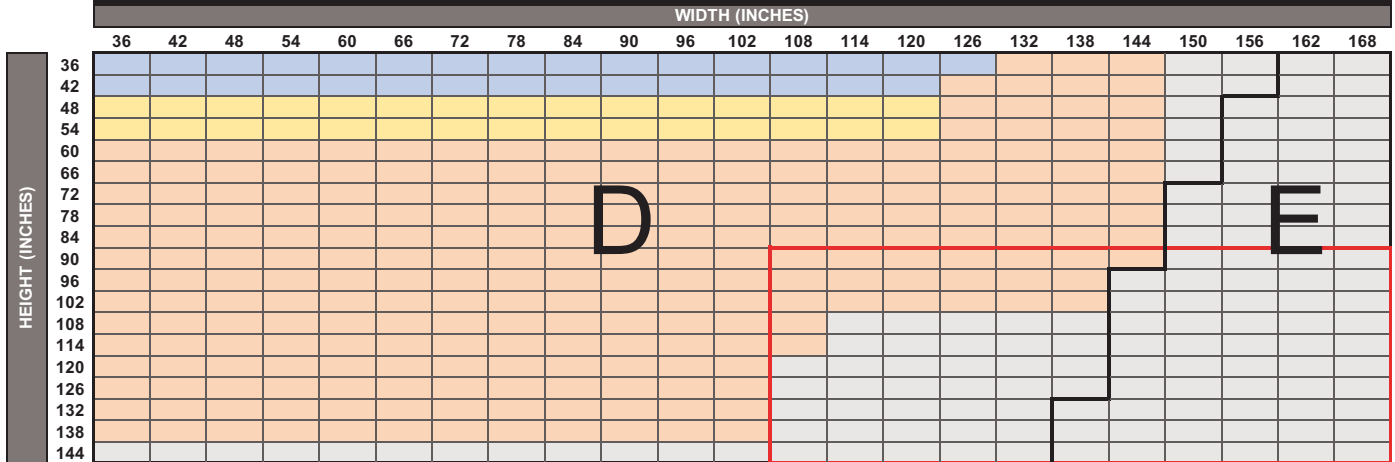

Control Systems (Minimum height for all Control Systems is 12")		Minimum Width (Single Panel)	Overall Minimum Width (2-on-1)	Specification Zone(s)*	Top Treatment
Lithium-ion Motors	Bliss™ 3.0 Li-Ion	32"	65"	D & E	All
	Sonessé® 40 WireFree™ RTS Li-Ion	31"	63"	D	
AC Motors	Bliss™ 10.0 AC	35"	NA	D & E	Open Roll, Fabric Cornice, and 4" Fascia
	Sonessé® 50 RTS AC (120V)	33"	NA	D & E	
	Sonessé® Ultra 50 AC (120V)	39"	NA	D & E	

*Not all fabrics are available in all zones

PRODUCT SIZE SPECIFICATIONS – CONTINUOUS LOOP CONTROL & AUTOMATION

Collection Code	Collection Name	Max Width Non-Railroaded ** (inches)	Max Width Railroaded (inches)	Available with Seam
R07	3% Sheerweave 5000 (02, 04, 05, 07, 10)	98	168	Yes

**To determine the maximum width for continuous Fabric Cornices, subtract 4 inches from the maximum non-railroad width.
Maximum height with Spring Assist on 4" Fascia is 90"
Not available with fabric-wrapped Square Cassette

· Railroad Fabrics (turned width for length) will have a visible seam when fabricated longer than the maximum roll width less 16".

· Red Box in spec chart indicates shade sizes Heat Sealed Hem Bar is recommended. For Continuous Loop Control, metal chain is also recommended for these sizes.

Top Treatment	Legend			
Medium Cassette				
3" Fascia				
Large Cassette				
Square Cassette				
Fabric Cornice				
4" Fascia				
Open Roll				

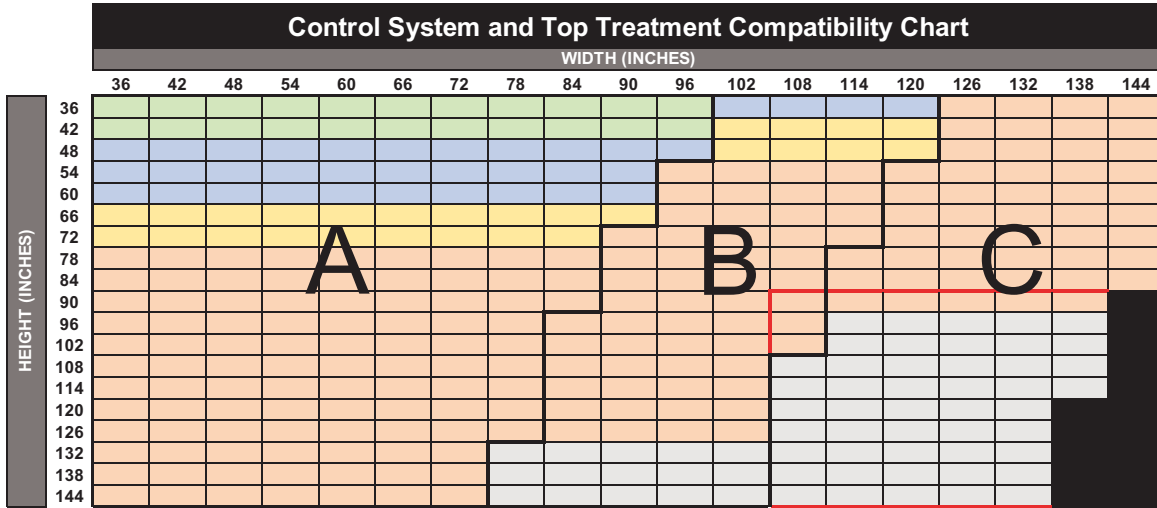

Control Systems (Minimum height for all Control Systems is 12")		Minimum Width (Single Panel)	Overall Minimum Width (2-on-1)	Specification Zone(s)*	Top Treatment
Continuous Loop Control	Continuous Loop Control (Maximum height for 12" width is 60")	12"	24"	A, B & C	All
	**Continuous Loop Control with Spring Assist	60"	NA	A, B & C	Open Roll & 4" Fascia
PowerWand	Powerwand 1.0 Li-Ion	21"	43"	A	All
	Powerwand 2.0 Li-Ion	22"	45"	A & B	(except 3" Fascia)
Lithium-ion Motors	Bliss™ 1.1 Li-Ion	21 1/2"	44"	A	All
	Bliss™ 2.0 Li-Ion	29"	59"	A & B	
	Sonesse® 28 WireFree™ RTS Li-Ion / Sonesse® 28 WireFree™ Zigbee Li-Ion	24 1/2"	50"	A	
	Sonesse® ULTRA 30 WireFree™ RTS Li-Ion	28 1/2"	58"	A & B	
DC Motors	Bliss™ 1.1 DC	16 1/2"	34"	A	All
	Bliss™ 2.0 DC	22 1/2"	46"	A & B	
	Sonesse® 28 WireFree™ RTS DC / Sonesse® 28 WireFree™ Zigbee DC	16 1/2"	34"	A	
	Sonesse® 30 RTS 24v DC	21"	NA	A & B	

**See Spring Assist Section in reference guide for details

*Not all fabrics are available in all zones

Control System and Top Treatment Compatibility Chart - High Torque Motors

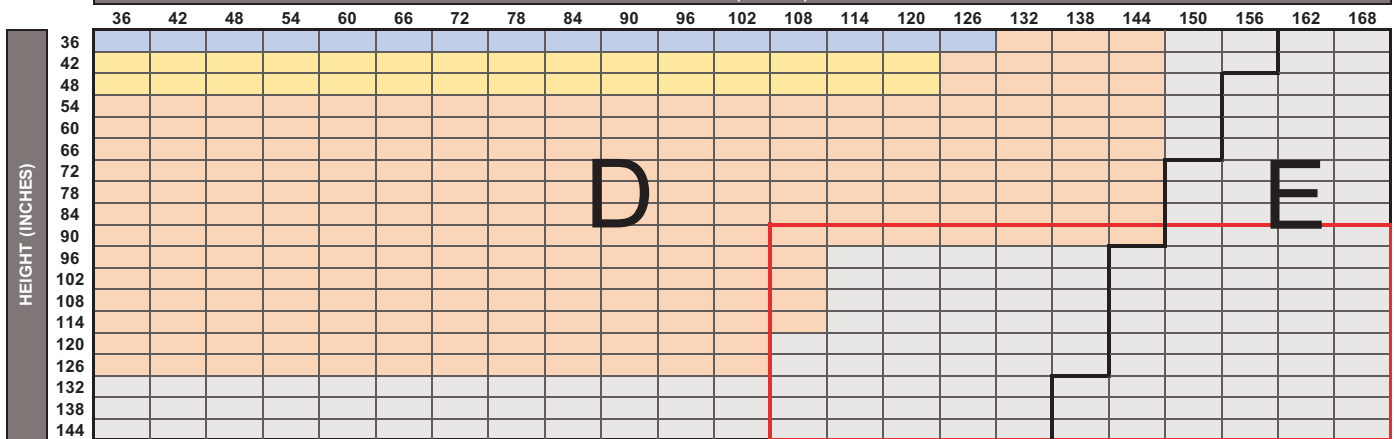

Control Systems (Minimum height for all Control Systems is 12")		Minimum Width (Single Panel)	Overall Minimum Width (2-on-1)	Specification Zone(s)*	Top Treatment
Lithium-ion Motors	Bliss™ 3.0 Li-Ion	32"	65"	D & E	All
	Sonesse® 40 WireFree™ RTS Li-Ion	31"	63"	D	
AC Motors	Bliss™ 10.0 AC	35"	NA	D & E	Open Roll, Fabric Cornice, and 4" Fascia
	Sonesse® 50 RTS AC (120V)	33"	NA	D & E	
	Sonesse® Ultra 50 AC (120V)	39"	NA	D & E	

*Not all fabrics are available in all zones

PRODUCT SIZE SPECIFICATIONS – CONTINUOUS LOOP CONTROL & AUTOMATION

Collection Code	Collection Name	Max Width Non-Railroaded ** (inches)	Max Width Railroaded (inches)	Available with Seam
AS006	3% Tweed Screen	118	168	Yes

**To determine the maximum width for continuous Fabric Cornices, subtract 4 inches from the maximum non-railroad width.

- Railroad Fabrics (turned width for length) will have a visible seam when fabricated longer than the maximum roll width less 16".
- Red Box in spec chart indicates shade sizes Heat Sealed Hem Bar is recommended. For Continuous Loop Control, metal chain is also recommended for these sizes.

Top Treatment	Legend			
Medium Cassette				
3" Fascia				
Large Cassette				
Square Cassette				
Fabric Cornice				
4" Fascia				
Open Roll				

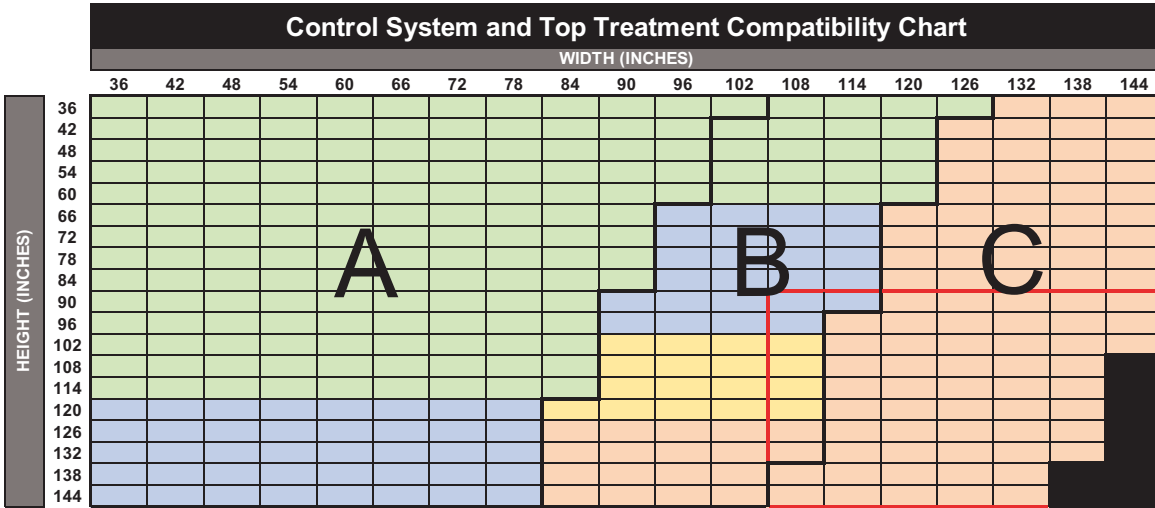

Control Systems (Minimum height for all Control Systems is 12")		Minimum Width (Single Panel)	Overall Minimum Width (2-on-1)	Specification Zone(s)*	Top Treatment
Continuous Loop Control	Continuous Loop Control (Maximum height for 12" width is 60")	12"	24"	A, B & C	All
	**Continuous Loop Control with Spring Assist	60"	NA	A, B & C	Open Roll & 4" Fascia
PowerWand	Powerwand 1.0 Li-Ion	21"	43"	A	All
	Powerwand 2.0 Li-Ion	22"	45"	A & B	(except 3" Fascia)
Lithium-ion Motors	Bliss™ 1.1 Li-Ion	21 1/2"	44"	A	All
	Bliss™ 2.0 Li-Ion	29"	59"	A & B	
	Sonesse® 28 WireFree™ RTS Li-Ion / Sonesse® 28 WireFree™ Zigbee Li-Ion	24 1/2"	50"	A	
	Sonesse® ULTRA 30 WireFree™ RTS Li-Ion	28 1/2"	58"	A & B	
DC Motors	Bliss™ 1.1 DC	16 1/2"	34"	A	All
	Bliss™ 2.0 DC	22 1/2"	46"	A & B	
	Sonesse® 28 WireFree™ RTS DC / Sonesse® 28 WireFree™ Zigbee DC	16 1/2"	34"	A	
	Sonesse® 30 RTS 24v DC	21"	NA	A & B	

**See Spring Assist Section in reference guide for details

*Not all fabrics are available in all zones

Control System and Top Treatment Compatibility Chart - High Torque Motors

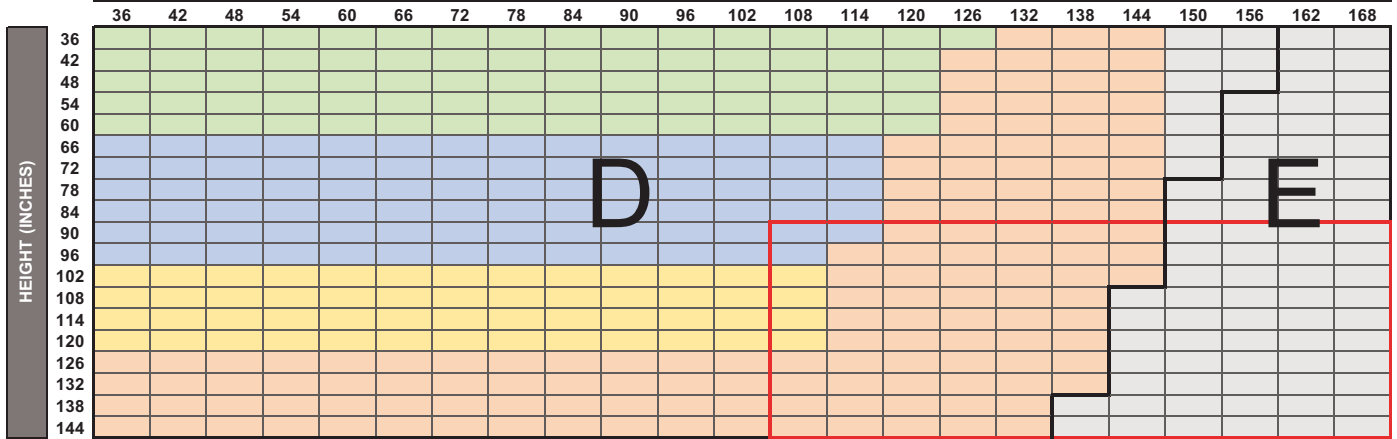

Control Systems (Minimum height for all Control Systems is 12")		Minimum Width (Single Panel)	Overall Minimum Width (2-on-1)	Specification Zone(s)*	Top Treatment
Lithium-ion Motors	Bliss™ 3.0 Li-Ion	32"	65"	D & E	All
	Sonesse® 40 WireFree™ RTS Li-Ion	31"	63"	D	
AC Motors	Bliss™ 10.0 AC	35"	NA	D & E	Open Roll, Fabric Cornice, and 4" Fascia
	Sonesse® 50 RTS AC (120V)	33"	NA	D & E	
	Sonesse® Ultra 50 AC (120V)	39"	NA	D & E	

*Not all fabrics are available in all zones

PRODUCT SIZE SPECIFICATIONS – CONTINUOUS LOOP CONTROL & AUTOMATION

Collection Code	Collection Name	Max Width Non-Railroaded ** (inches)	Max Width Railroaded (inches)	Available with Seam
RS15	4% S Screen	122	NA	No

**To determine the maximum width for continuous Fabric Cornices, subtract 4 inches from the maximum non-railroad width.

- Railroad Fabrics (turned width for length) will have a visible seam when fabricated longer than the maximum roll width less 16".
- Red Box in spec chart indicates shade sizes Heat Sealed Hem Bar is recommended. For Continuous Loop Control, metal chain is also recommended for these sizes.

Top Treatment	Legend			
Medium Cassette				
3" Fascia				
Large Cassette				
Square Cassette				
Fabric Cornice				
4" Fascia				
Open Roll				

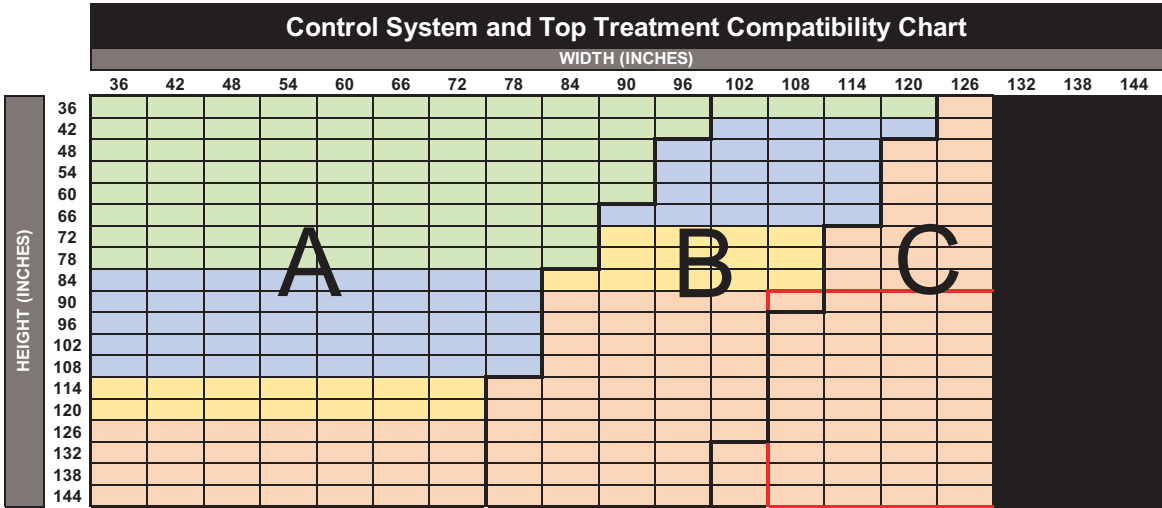

Control Systems (Minimum height for all Control Systems is 12")		Minimum Width (Single Panel)	Overall Minimum Width (2-on-1)	Specification Zone(s)*	Top Treatment
Continuous Loop Control	Continuous Loop Control (Maximum height for 12" width is 60")	12"	24"	A, B & C	All
	**Continuous Loop Control with Spring Assist	60"	NA	A, B & C	Open Roll & 4" Fascia
PowerWand	Powerwand 1.0 Li-Ion	21"	43"	A	All
	Powerwand 2.0 Li-Ion	22"	45"	A & B	(except 3" Fascia)
Lithium-ion Motors	Bliss™ 1.1 Li-Ion	21 1/2"	44"	A	All
	Bliss™ 2.0 Li-Ion	29"	59"	A & B	
	Sonesse® 28 WireFree™ RTS Li-Ion / Sonesse® 28 WireFree™ Zigbee Li-Ion	24 1/2"	50"	A	
	Sonesse® ULTRA 30 WireFree™ RTS Li-Ion	28 1/2"	58"	A & B	
DC Motors	Bliss™ 1.1 DC	16 1/2"	34"	A	All
	Bliss™ 2.0 DC	22 1/2"	46"	A & B	
	Sonesse® 28 WireFree™ RTS DC / Sonesse® 28 WireFree™ Zigbee DC	16 1/2"	34"	A	
	Sonesse® 30 RTS 24v DC	21"	NA	A & B	

**See Spring Assist Section in reference guide for details

*Not all fabrics are available in all zones

Control System and Top Treatment Compatibility Chart - High Torque Motors

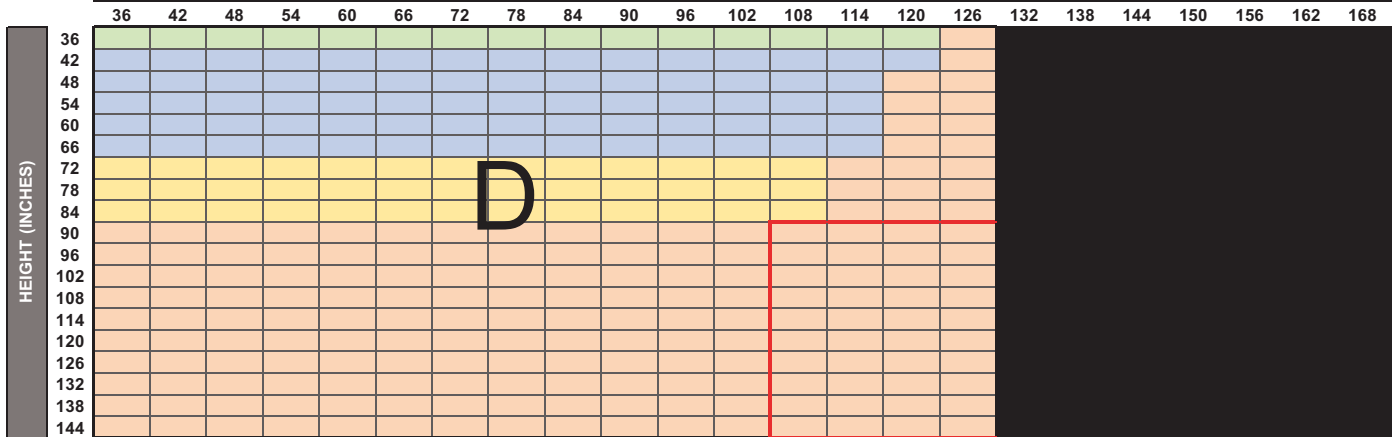

Control Systems (Minimum height for all Control Systems is 12")		Minimum Width (Single Panel)	Overall Minimum Width (2-on-1)	Specification Zone(s)*	Top Treatment
Lithium-ion Motors	Bliss™ 3.0 Li-Ion	32"	65"	D & E	All
	Sonesse® 40 WireFree™ RTS Li-Ion	31"	63"	D	
AC Motors	Bliss™ 10.0 AC	35"	NA	D & E	Open Roll, Fabric Cornice, and 4" Fascia
	Sonesse® 50 RTS AC (120V)	33"	NA	D & E	
	Sonesse® Ultra 50 AC (120V)	39"	NA	D & E	

*Not all fabrics are available in all zones

PRODUCT SIZE SPECIFICATIONS – CONTINUOUS LOOP CONTROL & AUTOMATION

Collection Code	Collection Name	Max Width Non-Railroaded ** (inches)	Max Width Railroaded (inches)	Available with Seam
R51	5% E Screen	122	168	Yes

**To determine the maximum width for continuous Fabric Cornices, subtract 4 inches from the maximum non-railroad width.

- Railroad Fabrics (turned width for length) will have a visible seam when fabricated longer than the maximum roll width less 16".
- Red Box in spec chart indicates shade sizes Heat Sealed Hem Bar is recommended. For Continuous Loop Control, metal chain is also recommended for these sizes.

Top Treatment	Legend			
Medium Cassette				
3" Fascia				
Large Cassette				
Square Cassette				
Fabric Cornice				
4" Fascia				
Open Roll				

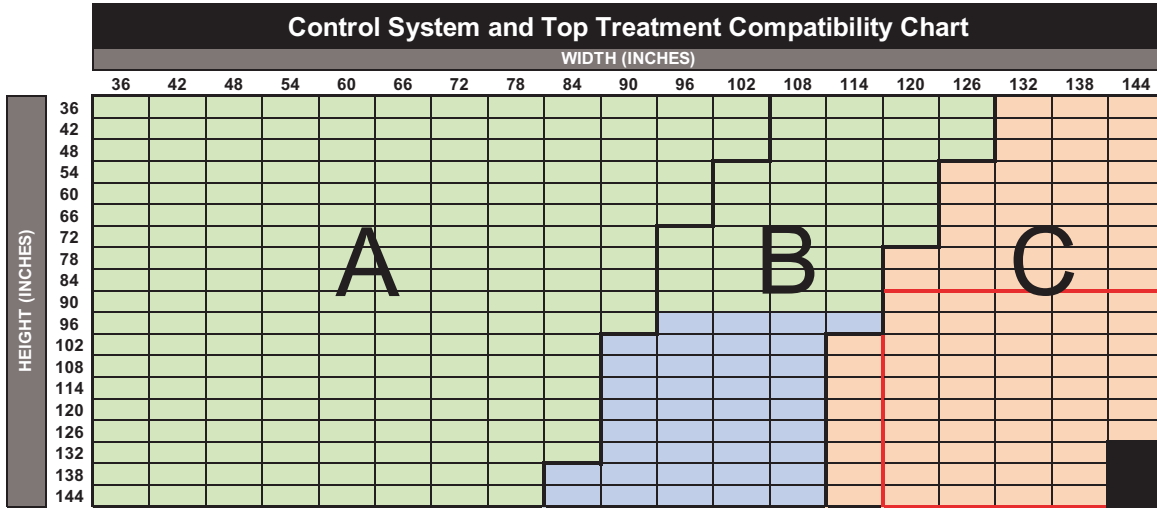

Control Systems (Minimum height for all Control Systems is 12")		Minimum Width (Single Panel)	Overall Minimum Width (2-on-1)	Specification Zone(s)*	Top Treatment
Continuous Loop Control	Continuous Loop Control (Maximum height for 12" width is 60")	12"	24"	A, B & C	All
	**Continuous Loop Control with Spring Assist	60"	NA	A, B & C	Open Roll & 4" Fascia
PowerWand	Powerwand 1.0 Li-Ion	21"	43"	A	All
	Powerwand 2.0 Li-Ion	22"	45"	A & B	(except 3" Fascia)
Lithium-ion Motors	Bliss™ 1.1 Li-Ion	21 1/2"	44"	A	All
	Bliss™ 2.0 Li-Ion	29"	59"	A & B	
	Sonessé® 28 WireFree™ RTS Li-Ion / Sonessé® 28 WireFree™ Zigbee Li-Ion	24 1/2"	50"	A	
	Sonessé® ULTRA 30 WireFree™ RTS Li-Ion	28 1/2"	58"	A & B	
DC Motors	Bliss™ 1.1 DC	16 1/2"	34"	A	All
	Bliss™ 2.0 DC	22 1/2"	46"	A & B	
	Sonessé® 28 WireFree™ RTS DC / Sonessé® 28 WireFree™ Zigbee DC	16 1/2"	34"	A	
	Sonessé® 30 RTS 24v DC	21"	NA	A & B	

**See Spring Assist Section in reference guide for details

*Not all fabrics are available in all zones

Control System and Top Treatment Compatibility Chart - High Torque Motors

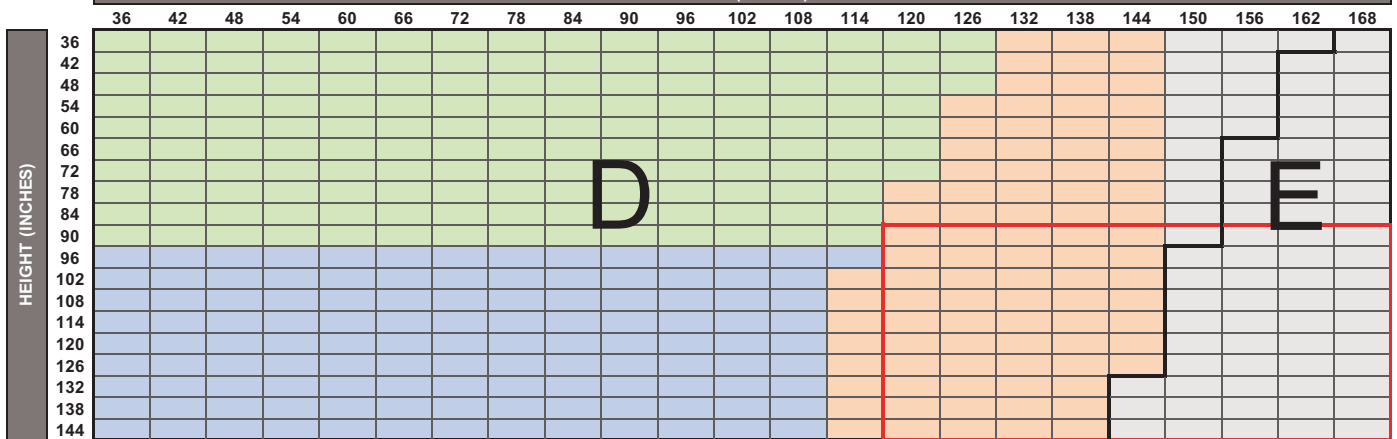

Control Systems (Minimum height for all Control Systems is 12")		Minimum Width (Single Panel)	Overall Minimum Width (2-on-1)	Specification Zone(s)*	Top Treatment
Lithium-ion Motors	Bliss™ 3.0 Li-Ion	32"	65"	D & E	All
	Sonessé® 40 WireFree™ RTS Li-Ion	31"	63"	D	
AC Motors	Bliss™ 10.0 AC	35"	NA	D & E	Open Roll, Fabric Cornice, and 4" Fascia
	Sonessé® 50 RTS AC (120V)	33"	NA	D & E	
	Sonessé® Ultra 50 AC (120V)	39"	NA	D & E	

*Not all fabrics are available in all zones

PRODUCT SIZE SPECIFICATIONS – CONTINUOUS LOOP CONTROL & AUTOMATION

Collection Code	Collection Name	Max Width Non-Railroaded ** (inches)	Max Width Railroaded (inches)	Available with Seam
AS009	5% Ecoscape Screen	118	NA	No

**To determine the maximum width for continuous Fabric Cornices, subtract 4 inches from the maximum non-railroad width.

- Railroad Fabrics (turned width for length) will have a visible seam when fabricated longer than the maximum roll width less 16".
- Red Box in spec chart indicates shade sizes Heat Sealed Hem Bar is recommended. For Continuous Loop Control, metal chain is also recommended for these sizes.

Top Treatment	Legend			
Medium Cassette				
3" Fascia				
Large Cassette				
Square Cassette				
Fabric Cornice				
4" Fascia				
Open Roll				

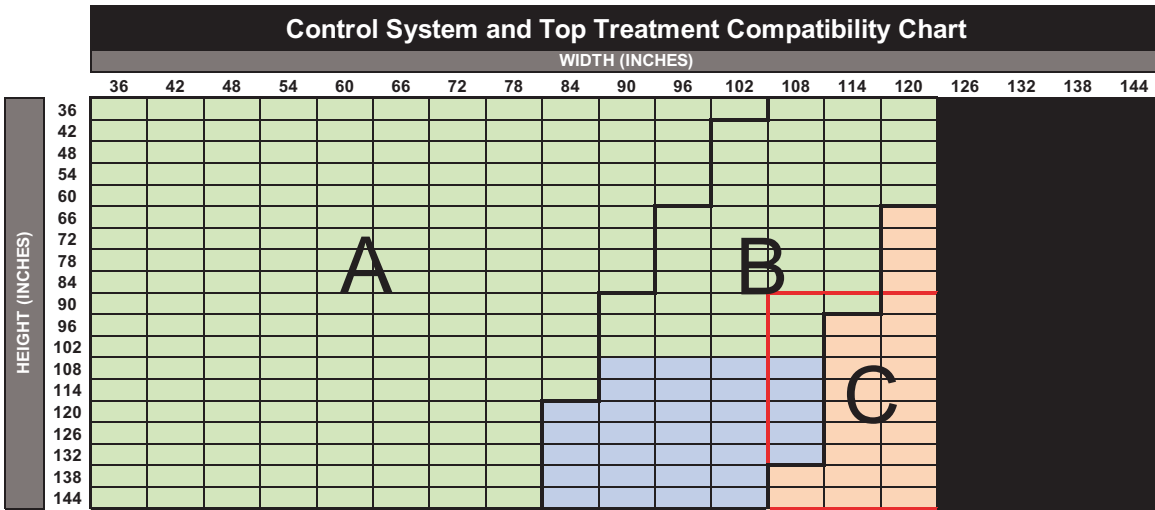

Control Systems (Minimum height for all Control Systems is 12")		Minimum Width (Single Panel)	Overall Minimum Width (2-on-1)	Specification Zone(s)*	Top Treatment
Continuous Loop Control	Continuous Loop Control (Maximum height for 12" width is 60")	12"	24"	A, B & C	All
	**Continuous Loop Control with Spring Assist	60"	NA	A, B & C	Open Roll & 4" Fascia
PowerWand	Powerwand 1.0 Li-Ion	21"	43"	A	All
	Powerwand 2.0 Li-Ion	22"	45"	A & B	(except 3" Fascia)
Lithium-ion Motors	Bliss™ 1.1 Li-Ion	21 1/2"	44"	A	All
	Bliss™ 2.0 Li-Ion	29"	59"	A & B	
	Sonessé® 28 WireFree™ RTS Li-Ion / Sonessé® 28 WireFree™ Zigbee Li-Ion	24 1/2"	50"	A	
	Sonessé® ULTRA 30 WireFree™ RTS Li-Ion	28 1/2"	58"	A & B	
DC Motors	Bliss™ 1.1 DC	16 1/2"	34"	A	All
	Bliss™ 2.0 DC	22 1/2"	46"	A & B	
	Sonessé® 28 WireFree™ RTS DC / Sonessé® 28 WireFree™ Zigbee DC	16 1/2"	34"	A	
	Sonessé® 30 RTS 24v DC	21"	NA	A & B	

**See Spring Assist Section in reference guide for details

*Not all fabrics are available in all zones

Control System and Top Treatment Compatibility Chart - High Torque Motors

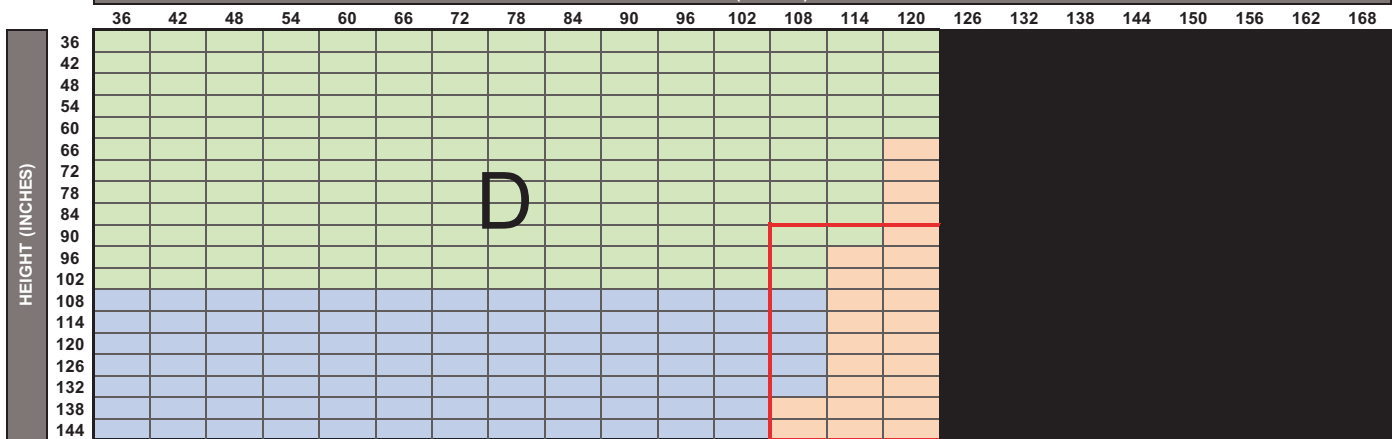

Control Systems (Minimum height for all Control Systems is 12")		Minimum Width (Single Panel)	Overall Minimum Width (2-on-1)	Specification Zone(s)*	Top Treatment
Lithium-ion Motors	Bliss™ 3.0 Li-Ion	32"	65"	D & E	All
	Sonessé® 40 WireFree™ RTS Li-Ion	31"	63"	D	
AC Motors	Bliss™ 10.0 AC	35"	NA	D & E	Open Roll, Fabric Cornice, and 4" Fascia
	Sonessé® 50 RTS AC (120V)	33"	NA	D & E	
	Sonessé® Ultra 50 AC (120V)	39"	NA	D & E	

*Not all fabrics are available in all zones

PRODUCT SIZE SPECIFICATIONS – CONTINUOUS LOOP CONTROL & AUTOMATION

Collection Code	Collection Name	Max Width Non-Railroaded ** (inches)	Max Width Railroaded (inches)	Available with Seam
AS012	5% EnduroScreen	98	168	Yes

**To determine the maximum width for continuous Fabric Cornices, subtract 4 inches from the maximum non-railroad width.

- Railroad Fabrics (turned width for length) will have a visible seam when fabricated longer than the maximum roll width less 16".
- Red Box in spec chart indicates shade sizes Heat Sealed Hem Bar is recommended. For Continuous Loop Control, metal chain is also recommended for these sizes.

Top Treatment	Legend			
Medium Cassette				
3" Fascia				
Large Cassette				
Square Cassette				
Fabric Cornice				
4" Fascia				
Open Roll				

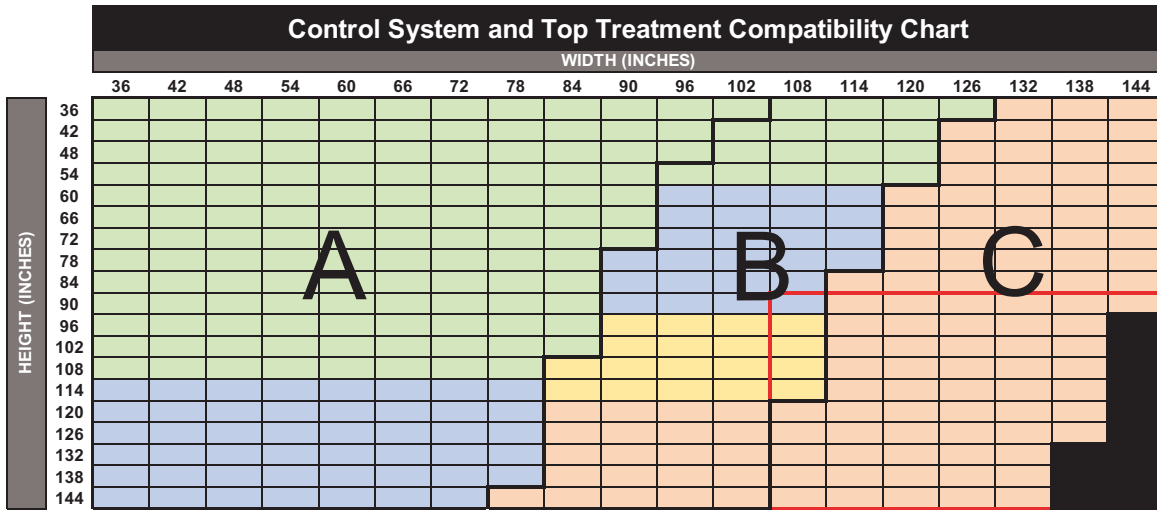

Control Systems (Minimum height for all Control Systems is 12")		Minimum Width (Single Panel)	Overall Minimum Width (2-on-1)	Specification Zone(s)*	Top Treatment
Continuous Loop Control	Continuous Loop Control (Maximum height for 12" width is 60")	12"	24"	A, B & C	All
	**Continuous Loop Control with Spring Assist	60"	NA	A, B & C	Open Roll & 4" Fascia
PowerWand	Powerwand 1.0 Li-Ion	21"	43"	A	All
	Powerwand 2.0 Li-Ion	22"	45"	A & B	(except 3" Fascia)
Lithium-ion Motors	Bliss™ 1.1 Li-Ion	21 1/2"	44"	A	All
	Bliss™ 2.0 Li-Ion	29"	59"	A & B	
	Sonessé® 28 WireFree™ RTS Li-Ion / Sonessé® 28 WireFree™ Zigbee Li-Ion	24 1/2"	50"	A	
	Sonessé® ULTRA 30 WireFree™ RTS Li-Ion	28 1/2"	58"	A & B	
DC Motors	Bliss™ 1.1 DC	16 1/2"	34"	A	All
	Bliss™ 2.0 DC	22 1/2"	46"	A & B	
	Sonessé® 28 WireFree™ RTS DC / Sonessé® 28 WireFree™ Zigbee DC	16 1/2"	34"	A	
	Sonessé® 30 RTS 24v DC	21"	NA	A & B	

**See Spring Assist Section in reference guide for details

*Not all fabrics are available in all zones

Control System and Top Treatment Compatibility Chart - High Torque Motors

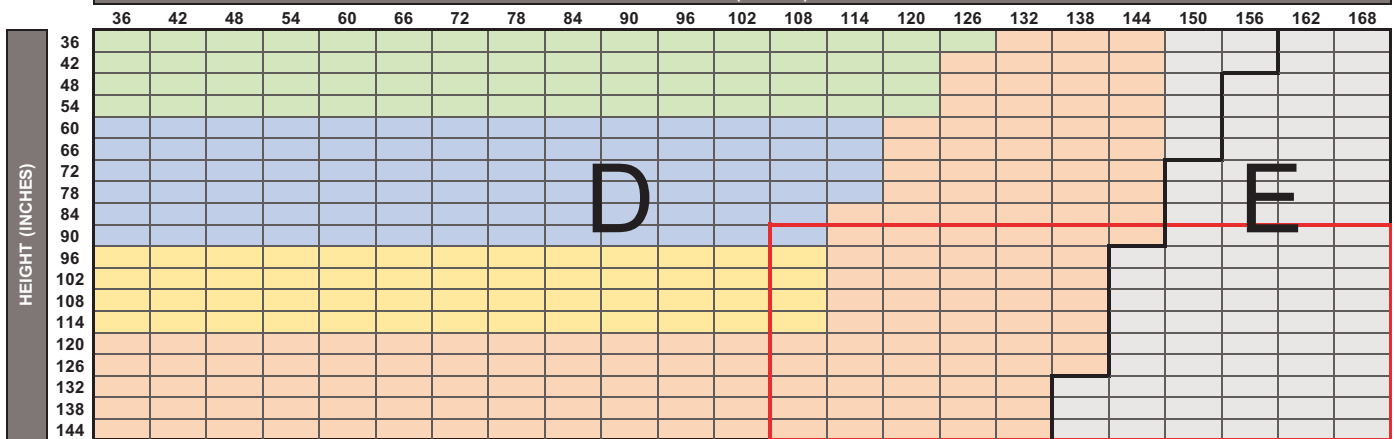

Control Systems (Minimum height for all Control Systems is 12")		Minimum Width (Single Panel)	Overall Minimum Width (2-on-1)	Specification Zone(s)*	Top Treatment
Lithium-ion Motors	Bliss™ 3.0 Li-Ion	32"	65"	D & E	All
	Sonessé® 40 WireFree™ RTS Li-Ion	31"	63"	D	
AC Motors	Bliss™ 10.0 AC	35"	NA	D & E	Open Roll, Fabric Cornice, and 4" Fascia
	Sonessé® 50 RTS AC (120V)	33"	NA	D & E	
	Sonessé® Ultra 50 AC (120V)	39"	NA	D & E	

*Not all fabrics are available in all zones

PRODUCT SIZE SPECIFICATIONS – CONTINUOUS LOOP CONTROL & AUTOMATION

Collection Code	Collection Name	Max Width Non-Railroaded ** (inches)	Max Width Railroaded (inches)	Available with Seam
AS015	5% Environs Screen	118	168	No

**To determine the maximum width for continuous Fabric Cornices, subtract 4 inches from the maximum non-railroad width. Maximum height is 102" when railroaded

- Railroad Fabrics (turned width for length) will have a visible seam when fabricated longer than the maximum roll width less 16".
- The **Red Box** in the spec chart indicates shade sizes metal chain is recommended for Continuous Loop Control.

Top Treatment	Legend			
Medium Cassette				
3" Fascia				
Large Cassette				
Square Cassette				
Fabric Cornice				
4" Fascia				
Open Roll				

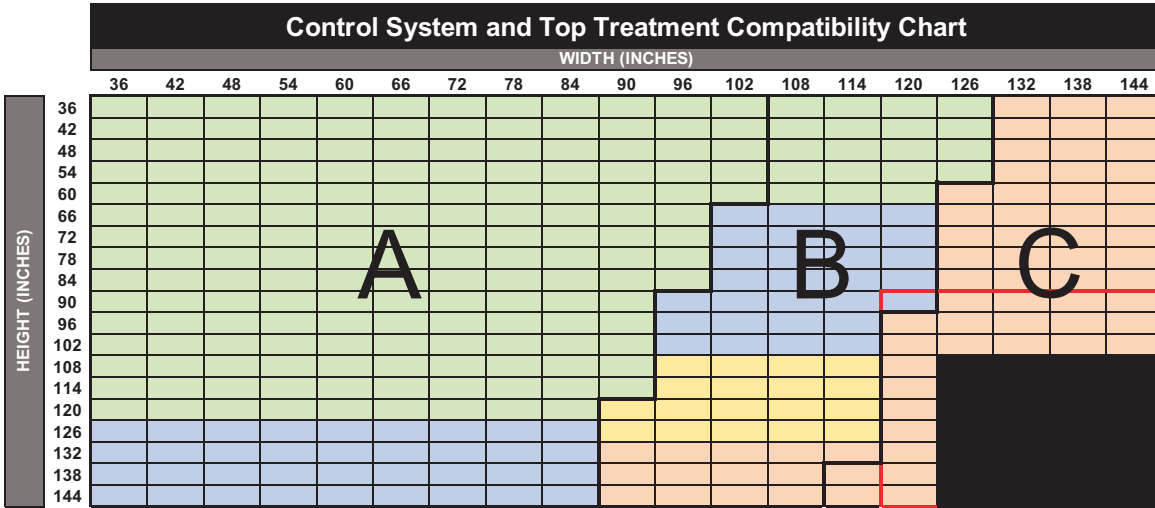

Control Systems (Minimum height for all Control Systems is 12")		Minimum Width (Single Panel)	Overall Minimum Width (2-on-1)	Specification Zone(s)*	Top Treatment
Continuous Loop Control	Continuous Loop Control (Maximum height for 12" width is 60")	12"	24"	A, B & C	All
	**Continuous Loop Control with Spring Assist	60"	NA	A, B & C	Open Roll & 4" Fascia
PowerWand	Powerwand 1.0 Li-Ion	21"	43"	A	All
	Powerwand 2.0 Li-Ion	22"	45"	A & B	(except 3" Fascia)
Lithium-ion Motors	Bliss™ 1.1 Li-Ion	21 1/2"	44"	A	All
	Bliss™ 2.0 Li-Ion	29"	59"	A & B	
	Sonessé® 28 WireFree™ RTS Li-Ion / Sonessé® 28 WireFree™ Zigbee Li-Ion	24 1/2"	50"	A	
	Sonessé® ULTRA 30 WireFree™ RTS Li-Ion	28 1/2"	58"	A & B	
DC Motors	Bliss™ 1.1 DC	16 1/2"	34"	A	All
	Bliss™ 2.0 DC	22 1/2"	46"	A & B	
	Sonessé® 28 WireFree™ RTS DC / Sonessé® 28 WireFree™ Zigbee DC	16 1/2"	34"	A	
	Sonessé® 30 RTS 24v DC	21"	NA	A & B	

**See Spring Assist Section in reference guide for details

*Not all fabrics are available in all zones

Control System and Top Treatment Compatibility Chart - High Torque Motors

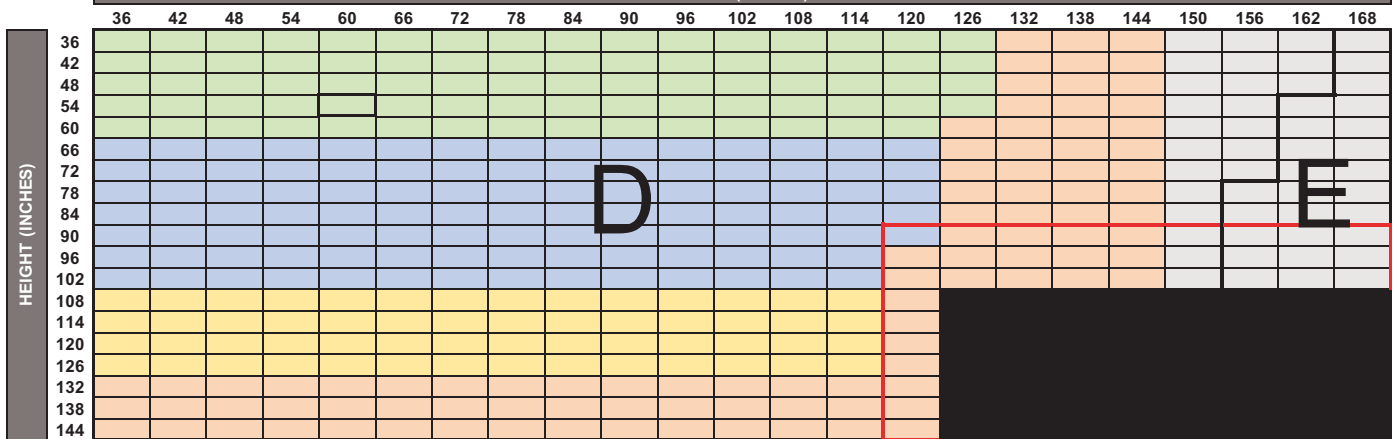

Control Systems (Minimum height for all Control Systems is 12")		Minimum Width (Single Panel)	Overall Minimum Width (2-on-1)	Specification Zone(s)*	Top Treatment
Lithium-ion Motors	Bliss™ 3.0 Li-Ion	32"	65"	D & E	All
	Sonessé® 40 WireFree™ RTS Li-Ion	31"	63"	D	
AC Motors	Bliss™ 10.0 AC	35"	NA	D & E	Open Roll, Fabric Cornice, and 4" Fascia
	Sonessé® 50 RTS AC (120V)	33"	NA	D & E	
	Sonessé® Ultra 50 AC (120V)	39"	NA	D & E	

*Not all fabrics are available in all zones

PRODUCT SIZE SPECIFICATIONS – CONTINUOUS LOOP CONTROL & AUTOMATION

Collection Code	Collection Name	Max Width Non-Railroaded ** (inches)	Max Width Railroaded (inches)	Available with Seam
R61	5% M Screen Deco	98	168	Yes

**To determine the maximum width for continuous Fabric Cornices, subtract 4 inches from the maximum non-railroad width.

- Railroad Fabrics (turned width for length) will have a visible seam when fabricated longer than the maximum roll width less 16".
- Red Box in spec chart indicates shade sizes Heat Sealed Hem Bar is recommended. For Continuous Loop Control, metal chain is also recommended for these sizes.

Top Treatment	Legend			
Medium Cassette	Green	Blue	Yellow	Orange
3" Fascia	Green	Blue	Yellow	Orange
Large Cassette	Green	Blue	Yellow	Orange
Square Cassette	Green	Blue	Yellow	Orange
Fabric Cornice	Green	Blue	Yellow	Orange
4" Fascia	Green	Blue	Yellow	Orange
Open Roll	Green	Blue	Yellow	Orange

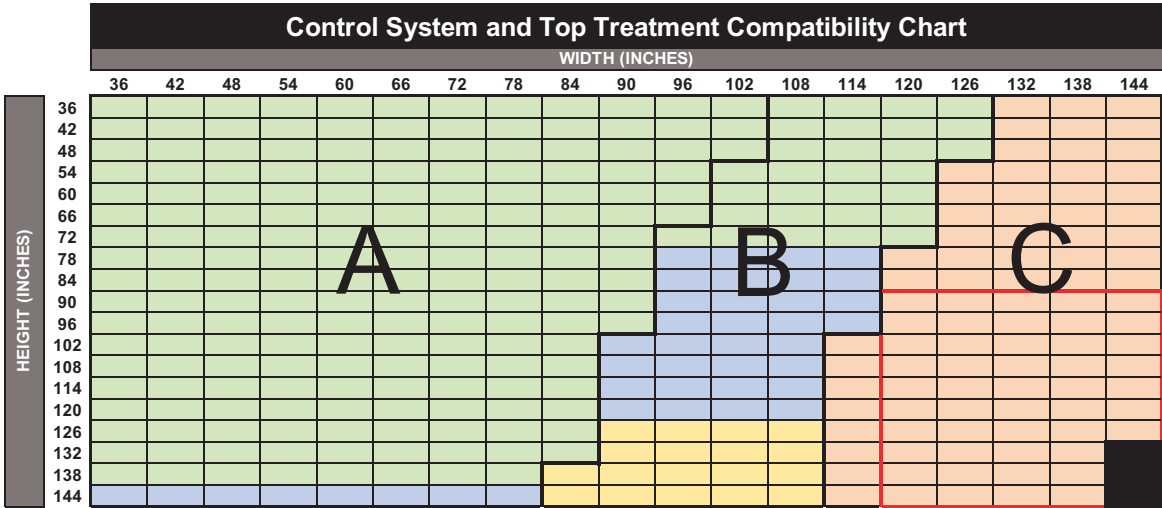

Control Systems (Minimum height for all Control Systems is 12")		Minimum Width (Single Panel)	Overall Minimum Width (2-on-1)	Specification Zone(s)*	Top Treatment
Continuous Loop Control	Continuous Loop Control (Maximum height for 12" width is 60")	12"	24"	A, B & C	All
	**Continuous Loop Control with Spring Assist	60"	NA	A, B & C	Open Roll & 4" Fascia
PowerWand	Powerwand 1.0 Li-Ion	21"	43"	A	All
	Powerwand 2.0 Li-Ion	22"	45"	A & B	(except 3" Fascia)
Lithium-ion Motors	Bliss™ 1.1 Li-Ion	21 1/2"	44"	A	All
	Bliss™ 2.0 Li-Ion	29"	59"	A & B	
	Sonessé® 28 WireFree™ RTS Li-Ion / Sonessé® 28 WireFree™ Zigbee Li-Ion	24 1/2"	50"	A	
	Sonessé® ULTRA 30 WireFree™ RTS Li-Ion	28 1/2"	58"	A & B	
DC Motors	Bliss™ 1.1 DC	16 1/2"	34"	A	All
	Bliss™ 2.0 DC	22 1/2"	46"	A & B	
	Sonessé® 28 WireFree™ RTS DC / Sonessé® 28 WireFree™ Zigbee DC	16 1/2"	34"	A	
	Sonessé® 30 RTS 24v DC	21"	NA	A & B	

**See Spring Assist Section in reference guide for details

*Not all fabrics are available in all zones

Control System and Top Treatment Compatibility Chart - High Torque Motors

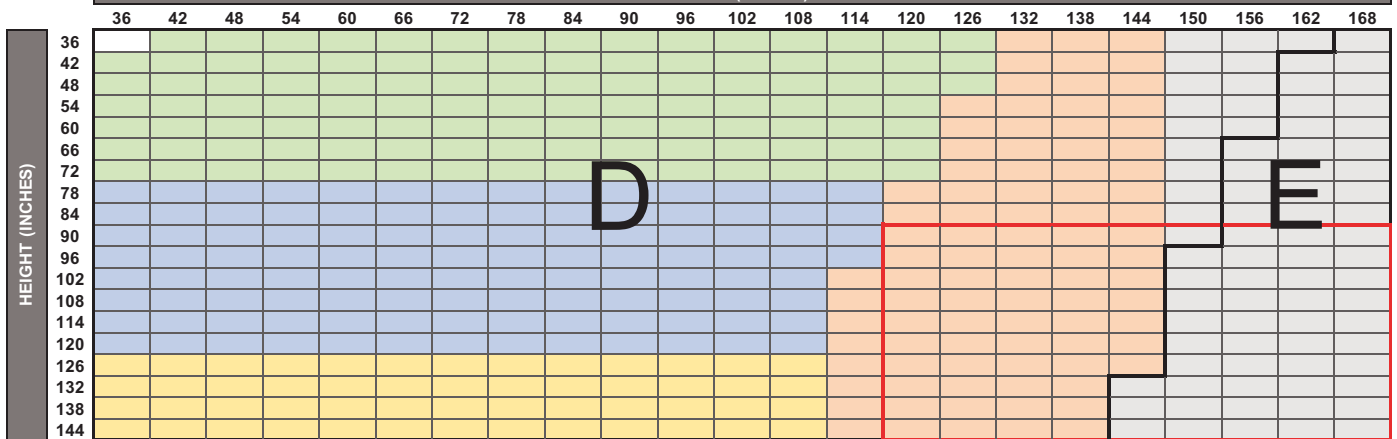

Control Systems (Minimum height for all Control Systems is 12")		Minimum Width (Single Panel)	Overall Minimum Width (2-on-1)	Specification Zone(s)*	Top Treatment
Lithium-ion Motors	Bliss™ 3.0 Li-Ion	32"	65"	D & E	All
	Sonessé® 40 WireFree™ RTS Li-Ion	31"	63"	D	
AC Motors	Bliss™ 10.0 AC	35"	NA	D & E	Open Roll, Fabric Cornice, and 4" Fascia
	Sonessé® 50 RTS AC (120V)	33"	NA	D & E	
	Sonessé® Ultra 50 AC (120V)	39"	NA	D & E	

*Not all fabrics are available in all zones

PRODUCT SIZE SPECIFICATIONS – CONTINUOUS LOOP CONTROL & AUTOMATION

Collection Code	Collection Name	Max Width Non-Railroaded ** (inches)	Max Width Railroaded (inches)	Available with Seam
RS25	5% Nordic Screen Plus	118	168	Yes

**To determine the maximum width for continuous Fabric Cornices, subtract 4 inches from the maximum non-railroad width.

- Railroad Fabrics (turned width for length) will have a visible seam when fabricated longer than the maximum roll width less 16".
- Red Box in spec chart indicates shade sizes Heat Sealed Hem Bar is recommended. For Continuous Loop Control, metal chain is also recommended for these sizes.

Top Treatment	Legend			
Medium Cassette				
3" Fascia				
Large Cassette				
Square Cassette				
Fabric Cornice				
4" Fascia				
Open Roll				

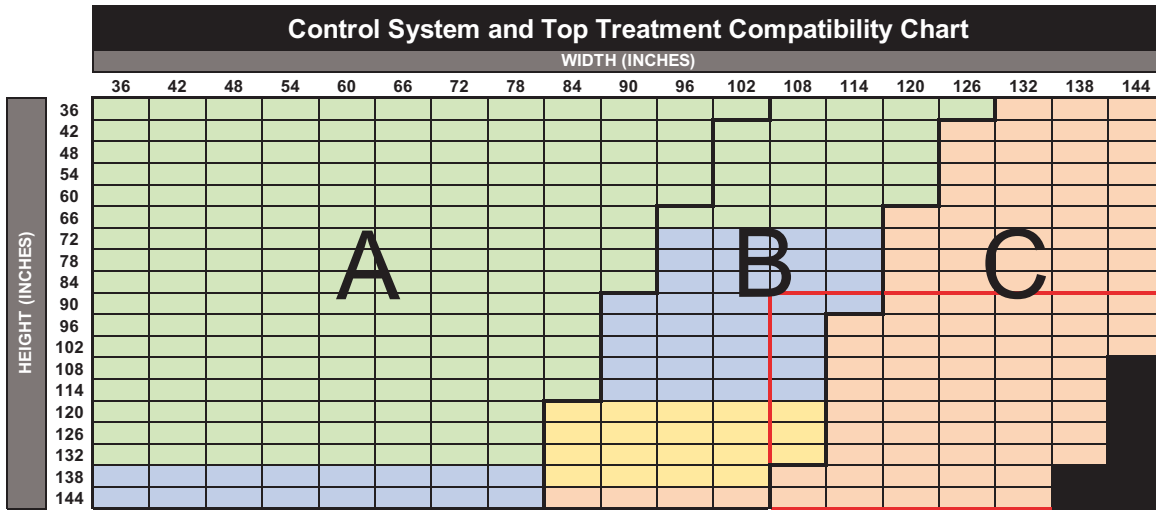

Control Systems (Minimum height for all Control Systems is 12")		Minimum Width (Single Panel)	Overall Minimum Width (2-on-1)	Specification Zone(s)*	Top Treatment
Continuous Loop Control	Continuous Loop Control (Maximum height for 12" width is 60")	12"	24"	A, B & C	All
	**Continuous Loop Control with Spring Assist	60"	NA	A, B & C	Open Roll & 4" Fascia
PowerWand	Powerwand 1.0 Li-Ion	21"	43"	A	All
	Powerwand 2.0 Li-Ion	22"	45"	A & B	(except 3" Fascia)
Lithium-ion Motors	Bliss™ 1.1 Li-Ion	21 1/2"	44"	A	All
	Bliss™ 2.0 Li-Ion	29"	59"	A & B	
	Sonessé® 28 WireFree™ RTS Li-Ion / Sonessé® 28 WireFree™ Zigbee Li-Ion	24 1/2"	50"	A	
	Sonessé® ULTRA 30 WireFree™ RTS Li-Ion	28 1/2"	58"	A & B	
DC Motors	Bliss™ 1.1 DC	16 1/2"	34"	A	All
	Bliss™ 2.0 DC	22 1/2"	46"	A & B	
	Sonessé® 28 WireFree™ RTS DC / Sonessé® 28 WireFree™ Zigbee DC	16 1/2"	34"	A	
	Sonessé® 30 RTS 24v DC	21"	NA	A & B	

**See Spring Assist Section in reference guide for details

*Not all fabrics are available in all zones

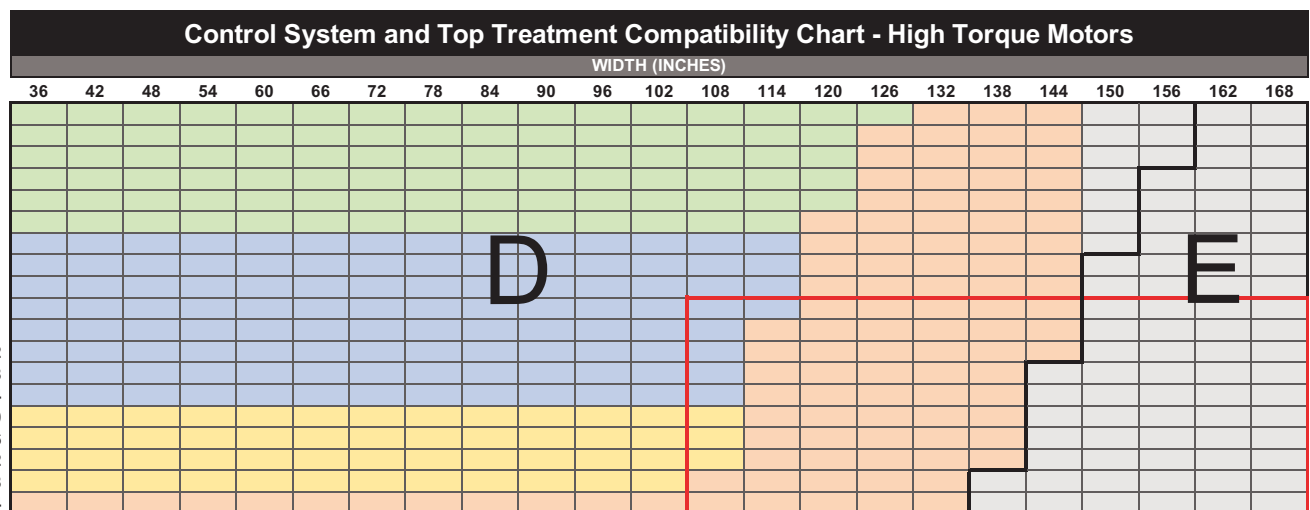

Control Systems (Minimum height for all Control Systems is 12")		Minimum Width (Single Panel)	Overall Minimum Width (2-on-1)	Specification Zone(s)*	Top Treatment
Lithium-ion Motors	Bliss™ 3.0 Li-Ion	32"	65"	D & E	All
	Sonessé® 40 WireFree™ RTS Li-Ion	31"	63"	D	
AC Motors	Bliss™ 10.0 AC	35"	NA	D & E	Open Roll, Fabric Cornice, and 4" Fascia
	Sonessé® 50 RTS AC (120V)	33"	NA	D & E	
	Sonessé® Ultra 50 AC (120V)	39"	NA	D & E	

*Not all fabrics are available in all zones

PRODUCT SIZE SPECIFICATIONS – CONTINUOUS LOOP CONTROL & AUTOMATION

Collection Code	Collection Name	Max Width Non-Railroaded ** (inches)	Max Width Railroaded (inches)	Available with Seam
P2000	5% Sheerweave 2000	126	168	Yes

**To determine the maximum width for continuous Fabric Cornices, subtract 4 inches from the maximum non-railroad width.

- Railroad Fabrics (turned width for length) will have a visible seam when fabricated longer than the maximum roll width less 16".
- Red Box in spec chart indicates shade sizes Heat Sealed Hem Bar is recommended. For Continuous Loop Control, metal chain is also recommended for these sizes.

Top Treatment	Legend			
Medium Cassette				
3" Fascia				
Large Cassette				
Square Cassette				
Fabric Cornice				
4" Fascia				
Open Roll				

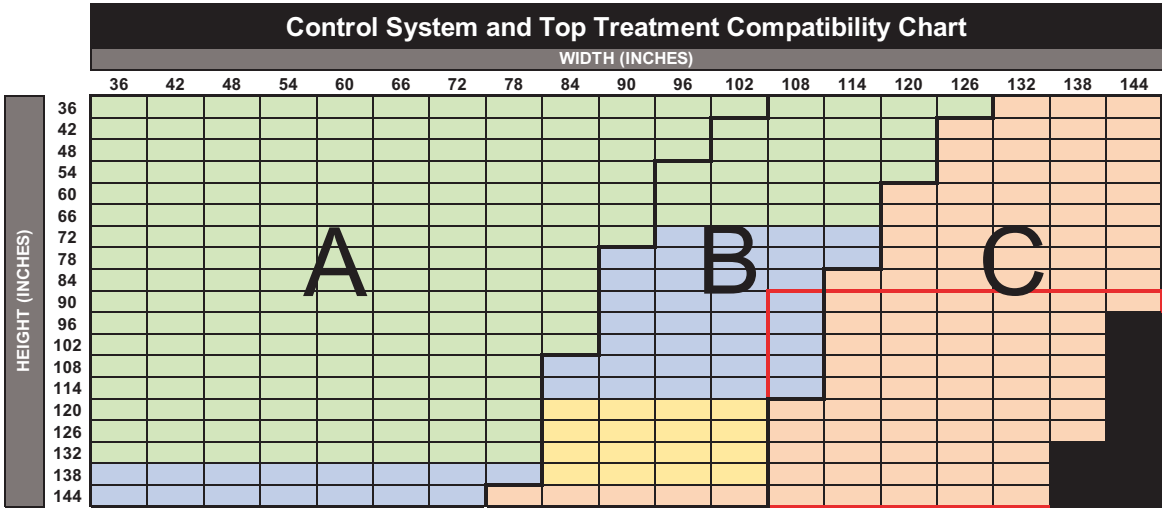

Control Systems (Minimum height for all Control Systems is 12")		Minimum Width (Single Panel)	Overall Minimum Width (2-on-1)	Specification Zone(s)*	Top Treatment
Continuous Loop Control	Continuous Loop Control (Maximum height for 12" width is 60")	12"	24"	A, B & C	All
	**Continuous Loop Control with Spring Assist	60"	NA	A, B & C	Open Roll & 4" Fascia
PowerWand	Powerwand 1.0 Li-Ion	21"	43"	A	All
	Powerwand 2.0 Li-Ion	22"	45"	A & B	(except 3" Fascia)
Lithium-ion Motors	Bliss™ 1.1 Li-Ion	21 1/2"	44"	A	All
	Bliss™ 2.0 Li-Ion	29"	59"	A & B	
	Sonessé® 28 WireFree™ RTS Li-Ion / Sonessé® 28 WireFree™ Zigbee Li-Ion	24 1/2"	50"	A	
	Sonessé® ULTRA 30 WireFree™ RTS Li-Ion	28 1/2"	58"	A & B	
DC Motors	Bliss™ 1.1 DC	16 1/2"	34"	A	All
	Bliss™ 2.0 DC	22 1/2"	46"	A & B	
	Sonessé® 28 WireFree™ RTS DC / Sonessé® 28 WireFree™ Zigbee DC	16 1/2"	34"	A	
	Sonessé® 30 RTS 24v DC	21"	NA	A & B	

**See Spring Assist Section in reference guide for details

*Not all fabrics are available in all zones

Control System and Top Treatment Compatibility Chart - High Torque Motors

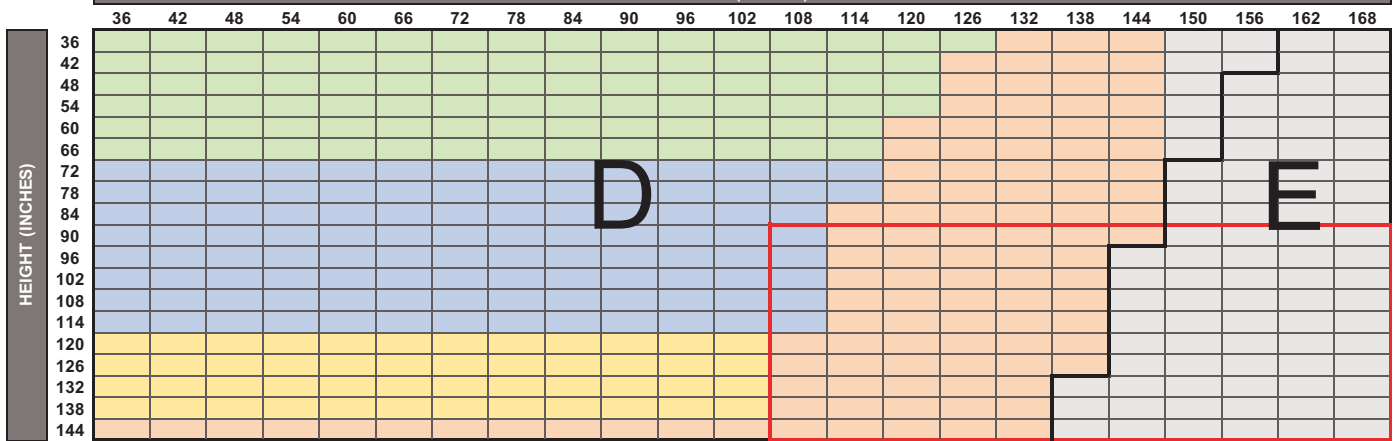

Control Systems (Minimum height for all Control Systems is 12")		Minimum Width (Single Panel)	Overall Minimum Width (2-on-1)	Specification Zone(s)*	Top Treatment
Lithium-ion Motors	Bliss™ 3.0 Li-Ion	32"	65"	D & E	All
	Sonessé® 40 WireFree™ RTS Li-Ion	31"	63"	D	
AC Motors	Bliss™ 10.0 AC	35"	NA	D & E	Open Roll, Fabric Cornice, and 4" Fascia
	Sonessé® 50 RTS AC (120V)	33"	NA	D & E	
	Sonessé® Ultra 50 AC (120V)	39"	NA	D & E	

*Not all fabrics are available in all zones

PRODUCT SIZE SPECIFICATIONS – CONTINUOUS LOOP CONTROL & AUTOMATION

Collection Code	Collection Name	Max Width Non-Railroaded ** (inches)	Max Width Railroaded (inches)	Available with Seam
RS1	5% Sheerweave 2390	126	168	Yes

**To determine the maximum width for continuous Fabric Cornices, subtract 4 inches from the maximum non-railroad width.

- Railroad Fabrics (turned width for length) will have a visible seam when fabricated longer than the maximum roll width less 16".
- Red Box in spec chart indicates shade sizes Heat Sealed Hem Bar is recommended. For Continuous Loop Control, metal chain is also recommended for these sizes.

Top Treatment	Legend			
Medium Cassette				
3" Fascia				
Large Cassette				
Square Cassette				
Fabric Cornice				
4" Fascia				
Open Roll				

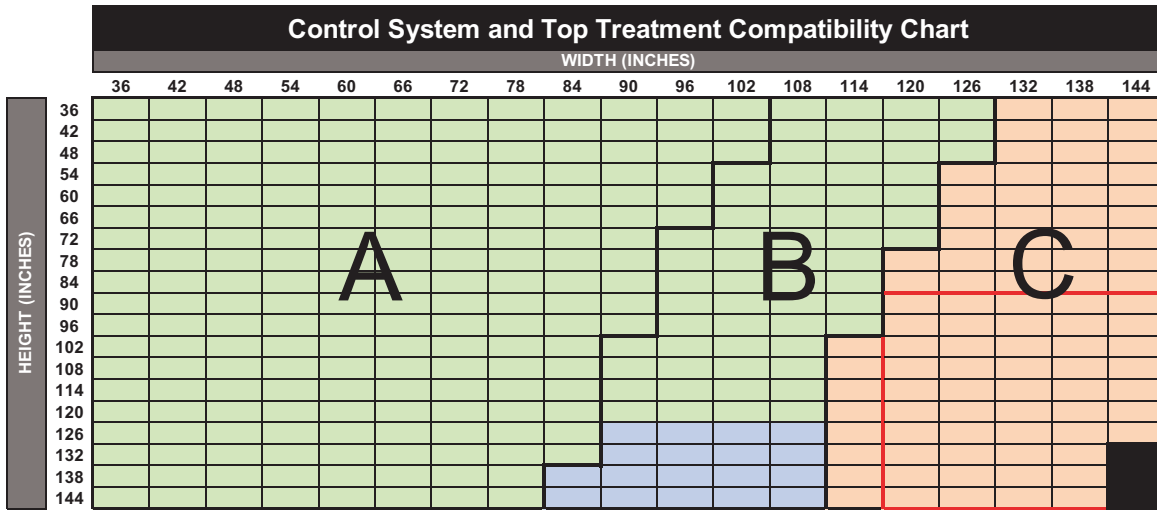

Control Systems (Minimum height for all Control Systems is 12")		Minimum Width (Single Panel)	Overall Minimum Width (2-on-1)	Specification Zone(s)*	Top Treatment
Continuous Loop Control	Continuous Loop Control (Maximum height for 12" width is 60")	12"	24"	A, B & C	All
	**Continuous Loop Control with Spring Assist	60"	NA	A, B & C	Open Roll & 4" Fascia
PowerWand	Powerwand 1.0 Li-Ion	21"	43"	A	All
	Powerwand 2.0 Li-Ion	22"	45"	A & B	(except 3" Fascia)
Lithium-ion Motors	Bliss™ 1.1 Li-Ion	21 1/2"	44"	A	All
	Bliss™ 2.0 Li-Ion	29"	59"	A & B	
	Sonessé® 28 WireFree™ RTS Li-Ion / Sonessé® 28 WireFree™ Zigbee Li-Ion	24 1/2"	50"	A	
	Sonessé® ULTRA 30 WireFree™ RTS Li-Ion	28 1/2"	58"	A & B	
DC Motors	Bliss™ 1.1 DC	16 1/2"	34"	A	All
	Bliss™ 2.0 DC	22 1/2"	46"	A & B	
	Sonessé® 28 WireFree™ RTS DC / Sonessé® 28 WireFree™ Zigbee DC	16 1/2"	34"	A	
	Sonessé® 30 RTS 24v DC	21"	NA	A & B	

**See Spring Assist Section in reference guide for details

*Not all fabrics are available in all zones

Control System and Top Treatment Compatibility Chart - High Torque Motors

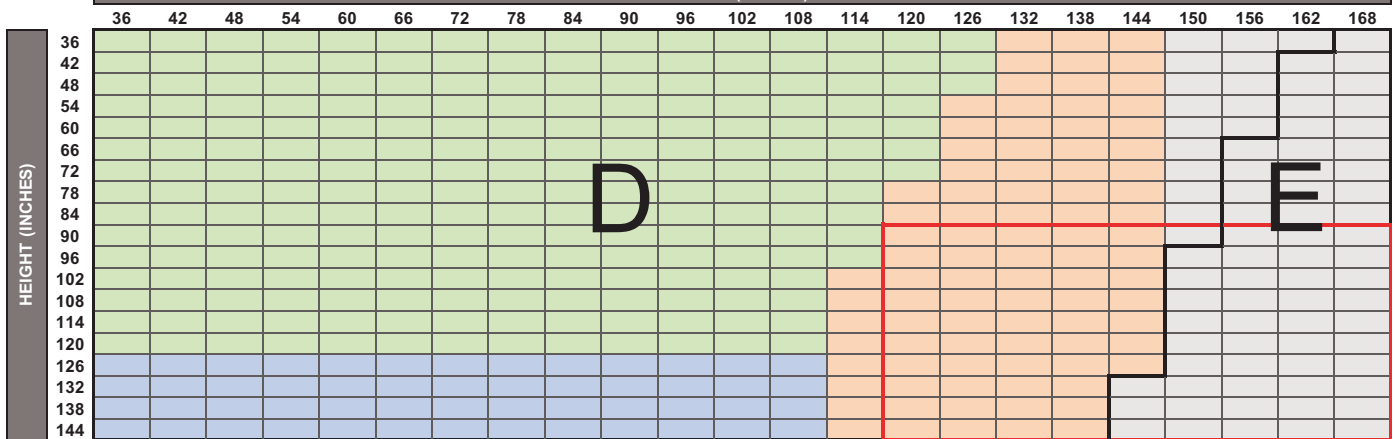

Control Systems (Minimum height for all Control Systems is 12")		Minimum Width (Single Panel)	Overall Minimum Width (2-on-1)	Specification Zone(s)*	Top Treatment
Lithium-ion Motors	Bliss™ 3.0 Li-Ion	32"	65"	D & E	All
	Sonessé® 40 WireFree™ RTS Li-Ion	31"	63"	D	
AC Motors	Bliss™ 10.0 AC	35"	NA	D & E	Open Roll, Fabric Cornice, and 4" Fascia
	Sonessé® 50 RTS AC (120V)	33"	NA	D & E	
	Sonessé® Ultra 50 AC (120V)	39"	NA	D & E	

*Not all fabrics are available in all zones

PRODUCT SIZE SPECIFICATIONS – CONTINUOUS LOOP CONTROL & AUTOMATION

Collection Code	Collection Name	Max Width Non-Railroaded ** (inches)	Max Width Railroaded (inches)	Available with Seam
P2705	5% Sheerweave 2705	98	168	Yes

**To determine the maximum width for continuous Fabric Cornices, subtract 4 inches from the maximum non-railroad width.

- Railroad Fabrics (turned width for length) will have a visible seam when fabricated longer than the maximum roll width less 16".
- Red Box in spec chart indicates shade sizes Heat Sealed Hem Bar is recommended. For Continuous Loop Control, metal chain is also recommended for these sizes.

Top Treatment	Legend			
Medium Cassette				
3" Fascia				
Large Cassette				
Square Cassette				
Fabric Cornice				
4" Fascia				
Open Roll				

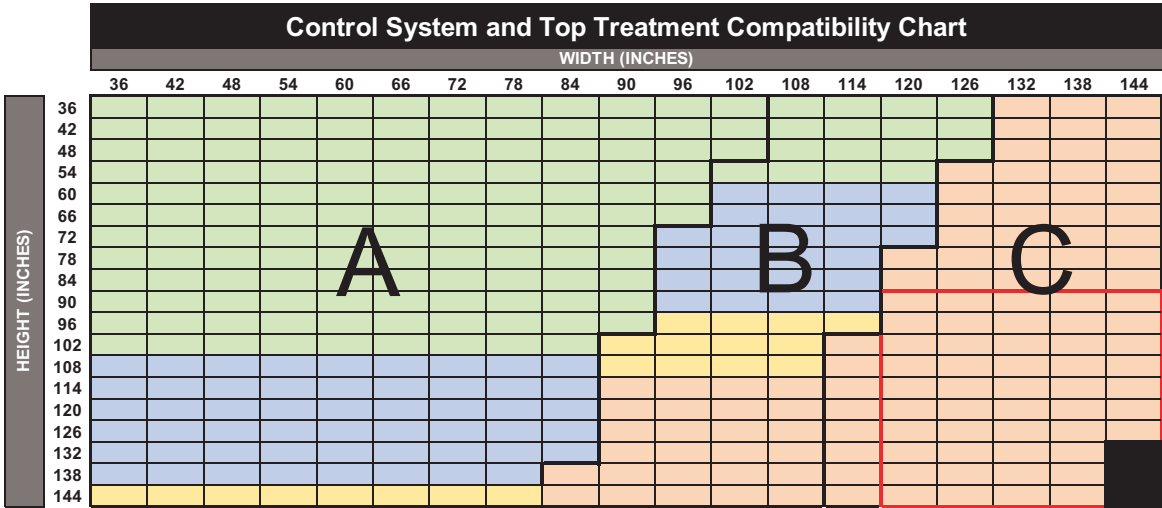

Control Systems (Minimum height for all Control Systems is 12")		Minimum Width (Single Panel)	Overall Minimum Width (2-on-1)	Specification Zone(s)*	Top Treatment
Continuous Loop Control	Continuous Loop Control (Maximum height for 12" width is 60")	12"	24"	A, B & C	All
	**Continuous Loop Control with Spring Assist	60"	NA	A, B & C	Open Roll & 4" Fascia
PowerWand	Powerwand 1.0 Li-Ion	21"	43"	A	All (except 3" Fascia)
	Powerwand 2.0 Li-Ion	22"	45"	A & B	
Lithium-ion Motors	Bliss™ 1.1 Li-Ion	21 1/2"	44"	A	All
	Bliss™ 2.0 Li-Ion	29"	59"	A & B	
	Soness® 28 WireFree™ RTS Li-Ion / Soness® 28 WireFree™ Zigbee Li-Ion	24 1/2"	50"	A	
	Soness® ULTRA 30 WireFree™ RTS Li-Ion	28 1/2"	58"	A & B	
DC Motors	Bliss™ 1.1 DC	16 1/2"	34"	A	All
	Bliss™ 2.0 DC	22 1/2"	46"	A & B	
	Soness® 28 WireFree™ RTS DC / Soness® 28 WireFree™ Zigbee DC	16 1/2"	34"	A	
	Soness® 30 RTS 24v DC	21"	NA	A & B	

**See Spring Assist Section in reference guide for details

*Not all fabrics are available in all zones

Control System and Top Treatment Compatibility Chart - High Torque Motors

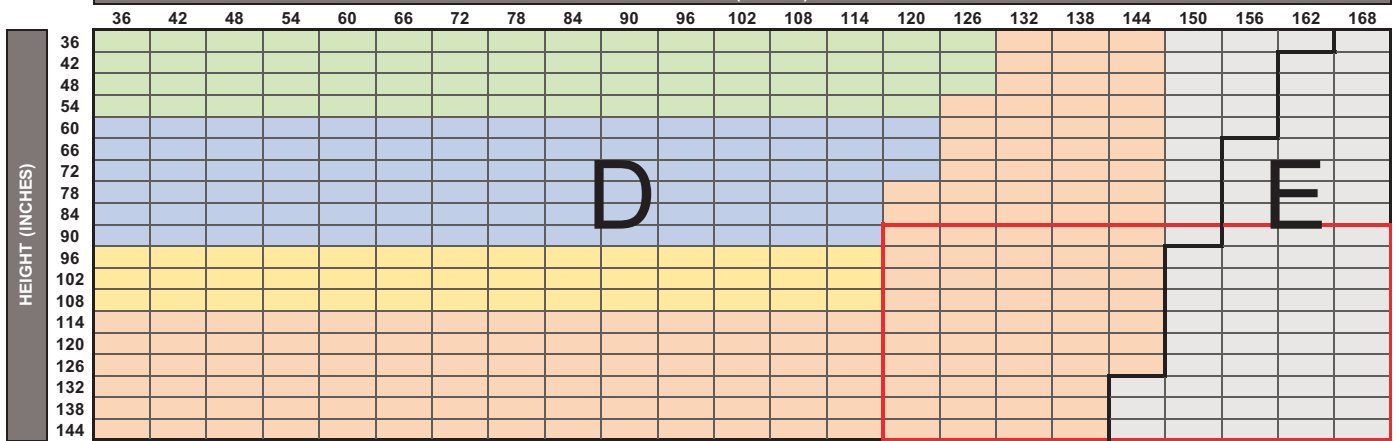

Control Systems (Minimum height for all Control Systems is 12")		Minimum Width (Single Panel)	Overall Minimum Width (2-on-1)	Specification Zone(s)*	Top Treatment
Lithium-ion Motors	Bliss™ 3.0 Li-Ion	32"	65"	D & E	All
	Soness® 40 WireFree™ RTS Li-Ion	31"	63"	D	
AC Motors	Bliss™ 10.0 AC	35"	NA	D & E	Open Roll, Fabric Cornice, and 4" Fascia
	Soness® 50 RTS AC (120V)	33"	NA	D & E	
	Soness® Ultra 50 AC (120V)	39"	NA	D & E	

*Not all fabrics are available in all zones

PRODUCT SIZE SPECIFICATIONS – CONTINUOUS LOOP CONTROL & AUTOMATION

Collection Code	Collection Name	Max Width Non-Railroaded ** (inches)	Max Width Railroaded (inches)	Available with Seam
R09	5% Sheerweave 4000	126	168	Yes

**To determine the maximum width for continuous Fabric Cornices, subtract 4 inches from the maximum non-railroad width.

- Railroad Fabrics (turned width for length) will have a visible seam when fabricated longer than the maximum roll width less 16".
- Red Box in spec chart indicates shade sizes Heat Sealed Hem Bar is recommended. For Continuous Loop Control, metal chain is also recommended for these sizes.

Top Treatment	Legend			
Medium Cassette				
3" Fascia				
Large Cassette				
Square Cassette				
Fabric Cornice				
4" Fascia				
Open Roll				

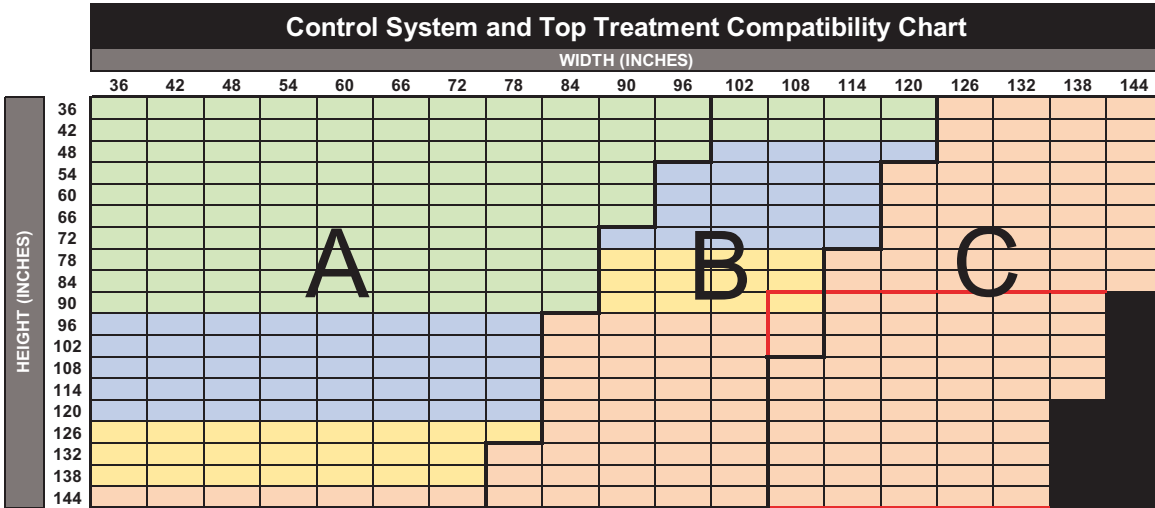

Control Systems (Minimum height for all Control Systems is 12")		Minimum Width (Single Panel)	Overall Minimum Width (2-on-1)	Specification Zone(s)*	Top Treatment
Continuous Loop Control	Continuous Loop Control (Maximum height for 12" width is 60")	12"	24"	A, B & C	All
	**Continuous Loop Control with Spring Assist	60"	NA	A, B & C	Open Roll & 4" Fascia
PowerWand	Powerwand 1.0 Li-Ion	21"	43"	A	All
	Powerwand 2.0 Li-Ion	22"	45"	A & B	(except 3" Fascia)
Lithium-ion Motors	Bliss™ 1.1 Li-Ion	21 1/2"	44"	A	All
	Bliss™ 2.0 Li-Ion	29"	59"	A & B	
	Sonesse® 28 WireFree™ RTS Li-Ion / Sonesse® 28 WireFree™ Zigbee Li-Ion	24 1/2"	50"	A	
	Sonesse® ULTRA 30 WireFree™ RTS Li-Ion	28 1/2"	58"	A & B	
DC Motors	Bliss™ 1.1 DC	16 1/2"	34"	A	All
	Bliss™ 2.0 DC	22 1/2"	46"	A & B	
	Sonesse® 28 WireFree™ RTS DC / Sonesse® 28 WireFree™ Zigbee DC	16 1/2"	34"	A	
	Sonesse® 30 RTS 24v DC	21"	NA	A & B	

**See Spring Assist Section in reference guide for details

*Not all fabrics are available in all zones

Control System and Top Treatment Compatibility Chart - High Torque Motors

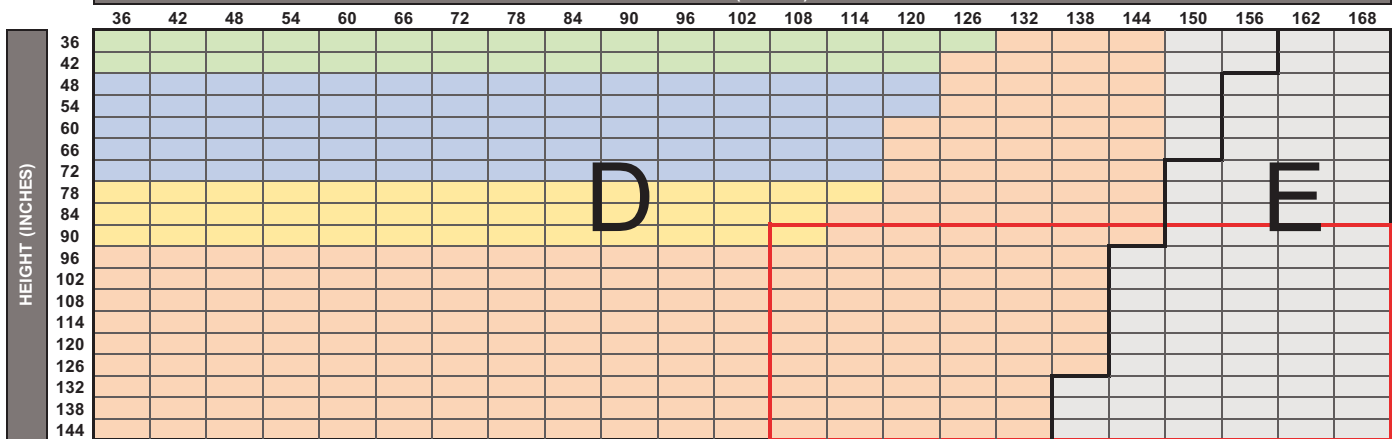

Control Systems (Minimum height for all Control Systems is 12")		Minimum Width (Single Panel)	Overall Minimum Width (2-on-1)	Specification Zone(s)*	Top Treatment
Lithium-ion Motors	Bliss™ 3.0 Li-Ion	32"	65"	D & E	All
	Sonesse® 40 WireFree™ RTS Li-Ion	31"	63"	D	
AC Motors	Bliss™ 10.0 AC	35"	NA	D & E	Open Roll, Fabric Cornice, and 4" Fascia
	Sonesse® 50 RTS AC (120V)	33"	NA	D & E	
	Sonesse® Ultra 50 AC (120V)	39"	NA	D & E	

*Not all fabrics are available in all zones

PRODUCT SIZE SPECIFICATIONS – CONTINUOUS LOOP CONTROL & AUTOMATION

Collection Code	Collection Name	Max Width Non-Railroaded ** (inches)	Max Width Railroaded (inches)	Available with Seam
P4500	5% Sheerweave 4500	126	168	Yes

**To determine the maximum width for continuous Fabric Cornices, subtract 4 inches from the maximum non-railroad width.

- Railroad Fabrics (turned width for length) will have a visible seam when fabricated longer than the maximum roll width less 16".
- Red Box in spec chart indicates shade sizes Heat Sealed Hem Bar is recommended. For Continuous Loop Control, metal chain is also recommended for these sizes.

Top Treatment	Legend			
Medium Cassette				
3" Fascia				
Large Cassette				
Square Cassette				
Fabric Cornice				
4" Fascia				
Open Roll				

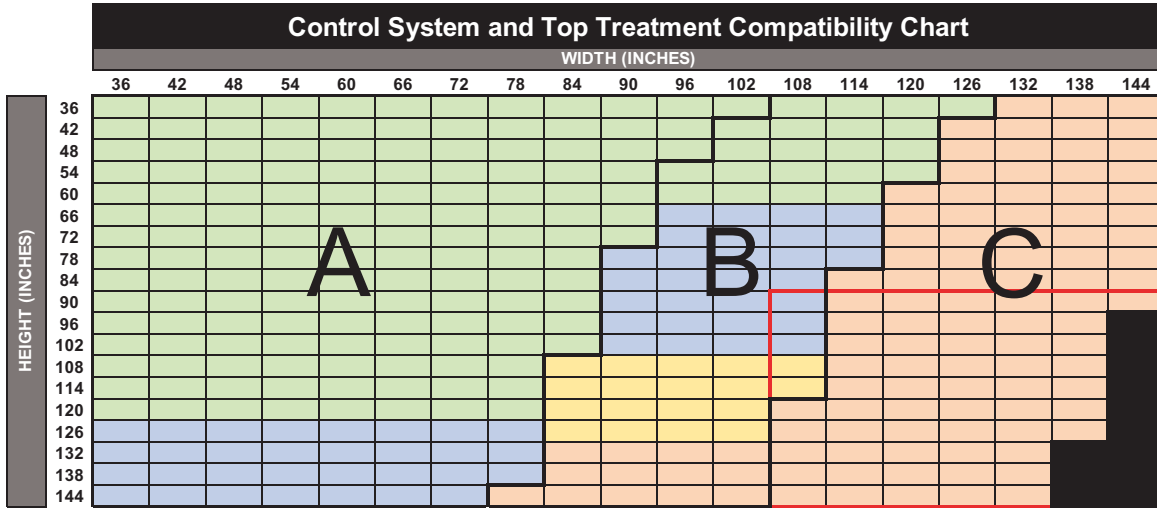

Control Systems (Minimum height for all Control Systems is 12")		Minimum Width (Single Panel)	Overall Minimum Width (2-on-1)	Specification Zone(s)*	Top Treatment
Continuous Loop Control	Continuous Loop Control (Maximum height for 12" width is 60")	12"	24"	A, B & C	All
	**Continuous Loop Control with Spring Assist	60"	NA	A, B & C	Open Roll & 4" Fascia
PowerWand	Powerwand 1.0 Li-Ion	21"	43"	A	All
	Powerwand 2.0 Li-Ion	22"	45"	A & B	(except 3" Fascia)
Lithium-ion Motors	Bliss™ 1.1 Li-Ion	21 1/2"	44"	A	All
	Bliss™ 2.0 Li-Ion	29"	59"	A & B	
	Sonessé® 28 WireFree™ RTS Li-Ion / Sonessé® 28 WireFree™ Zigbee Li-Ion	24 1/2"	50"	A	
	Sonessé® ULTRA 30 WireFree™ RTS Li-Ion	28 1/2"	58"	A & B	
DC Motors	Bliss™ 1.1 DC	16 1/2"	34"	A	All
	Bliss™ 2.0 DC	22 1/2"	46"	A & B	
	Sonessé® 28 WireFree™ RTS DC / Sonessé® 28 WireFree™ Zigbee DC	16 1/2"	34"	A	
	Sonessé® 30 RTS 24v DC	21"	NA	A & B	

**See Spring Assist Section in reference guide for details

*Not all fabrics are available in all zones

Control System and Top Treatment Compatibility Chart - High Torque Motors

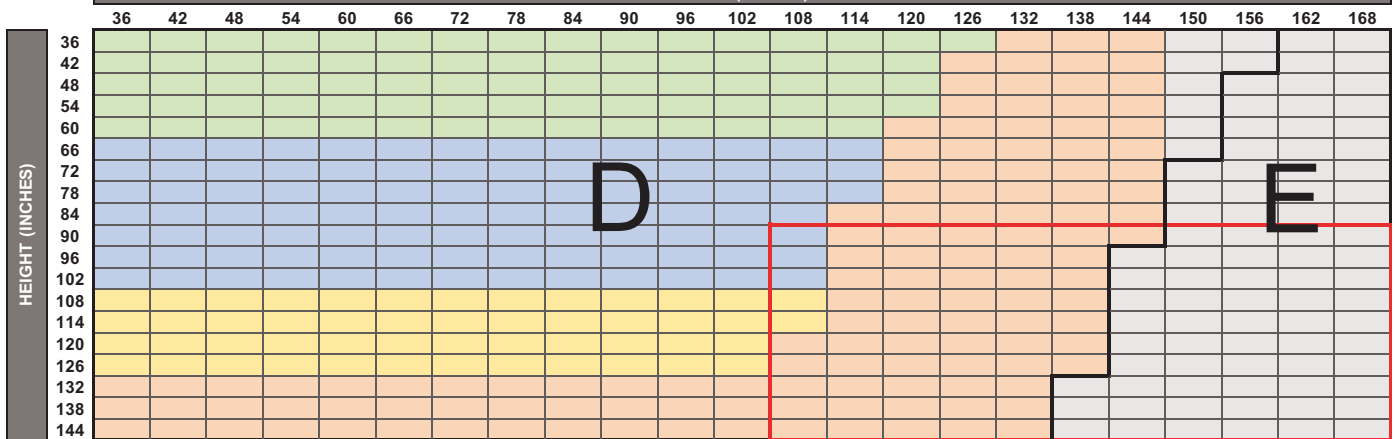

Control Systems (Minimum height for all Control Systems is 12")		Minimum Width (Single Panel)	Overall Minimum Width (2-on-1)	Specification Zone(s)*	Top Treatment
Lithium-ion Motors	Bliss™ 3.0 Li-Ion	32"	65"	D & E	All
	Sonessé® 40 WireFree™ RTS Li-Ion	31"	63"	D	
AC Motors	Bliss™ 10.0 AC	35"	NA	D & E	Open Roll, Fabric Cornice, and 4" Fascia
	Sonessé® 50 RTS AC (120V)	33"	NA	D & E	
	Sonessé® Ultra 50 AC (120V)	39"	NA	D & E	

*Not all fabrics are available in all zones

PRODUCT SIZE SPECIFICATIONS – CONTINUOUS LOOP CONTROL & AUTOMATION

Collection Code	Collection Name	Max Width Non-Railroaded ** (inches)	Max Width Railroaded (inches)	Available with Seam
R10	5% Sheerweave 5000 (Q43)	98	168	Yes

Top Treatment	Legend			
Medium Cassette				
3" Fascia				
Large Cassette				
Square Cassette				
Fabric Cornice				
4" Fascia				
Open Roll				

**To determine the maximum width for continuous Fabric Cornices, subtract 4 inches from the maximum non-railroad width.

- Railroad Fabrics (turned width for length) will have a visible seam when fabricated longer than the maximum roll width less 16".
- Red Box in spec chart indicates shade sizes Heat Sealed Hem Bar is recommended. For Continuous Loop Control, metal chain is also recommended for these sizes.

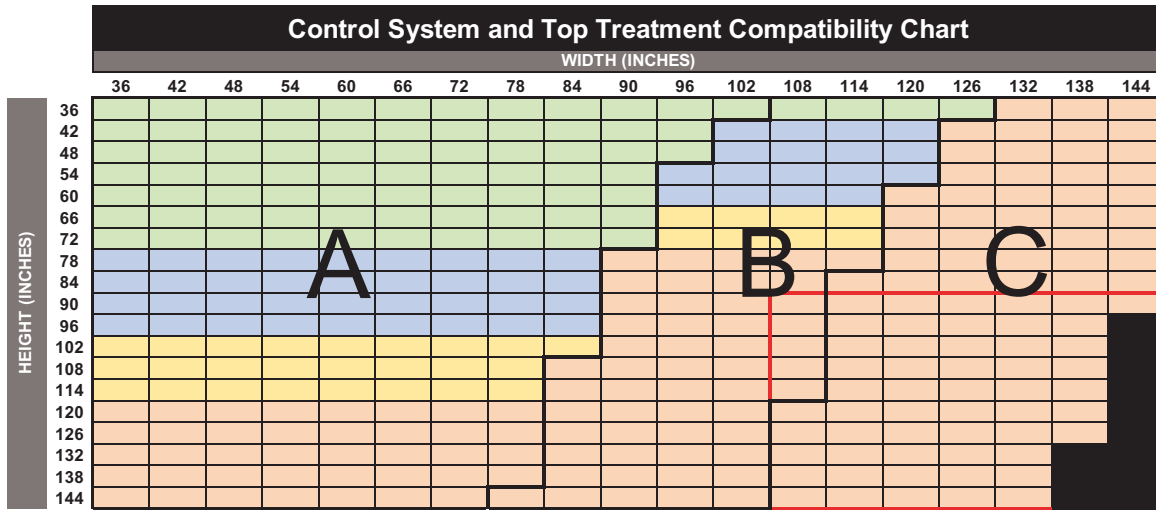

Control Systems (Minimum height for all Control Systems is 12")		Minimum Width (Single Panel)	Overall Minimum Width (2-on-1)	Specification Zone(s)*	Top Treatment
Continuous Loop Control	Continuous Loop Control (Maximum height for 12" width is 60")	12"	24"	A, B & C	All
	**Continuous Loop Control with Spring Assist	60"	NA	A, B & C	Open Roll & 4" Fascia
PowerWand	Powerwand 1.0 Li-Ion	21"	43"	A	All
	Powerwand 2.0 Li-Ion	22"	45"	A & B	(except 3" Fascia)
Lithium-ion Motors	Bliss™ 1.1 Li-Ion	21 1/2"	44"	A	All
	Bliss™ 2.0 Li-Ion	29"	59"	A & B	
	Sonesse® 28 WireFree™ RTS Li-Ion / Sonesse® 28 WireFree™ Zigbee Li-Ion	24 1/2"	50"	A	
	Sonesse® ULTRA 30 WireFree™ RTS Li-Ion	28 1/2"	58"	A & B	
DC Motors	Bliss™ 1.1 DC	16 1/2"	34"	A	All
	Bliss™ 2.0 DC	22 1/2"	46"	A & B	
	Sonesse® 28 WireFree™ RTS DC / Sonesse® 28 WireFree™ Zigbee DC	16 1/2"	34"	A	
	Sonesse® 30 RTS 24v DC	21"	NA	A & B	

**See Spring Assist Section in reference guide for details

*Not all fabrics are available in all zones

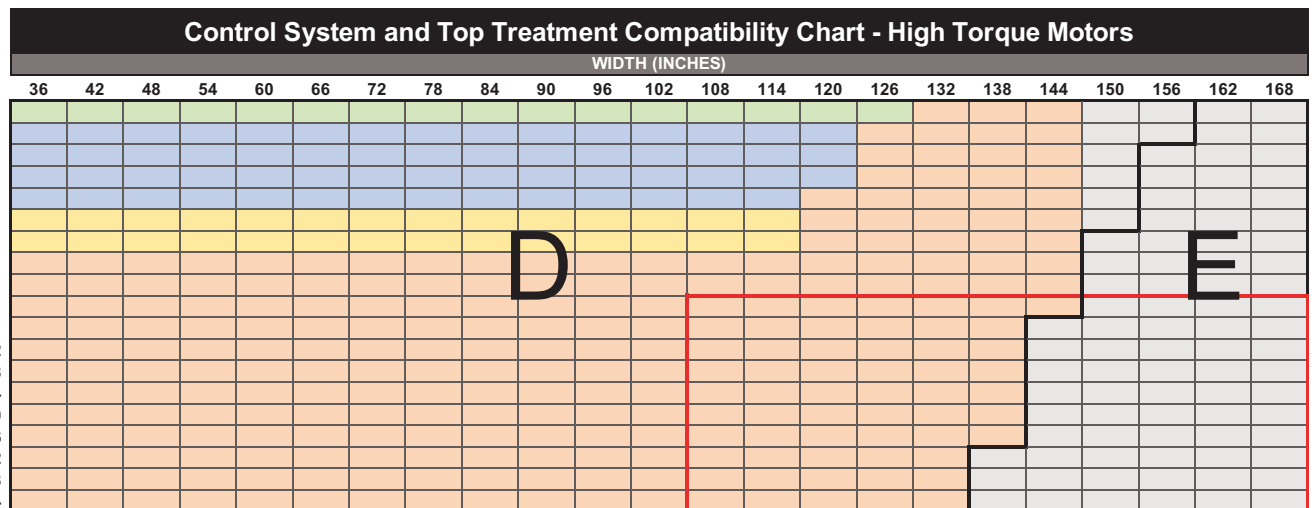

Control Systems (Minimum height for all Control Systems is 12")		Minimum Width (Single Panel)	Overall Minimum Width (2-on-1)	Specification Zone(s)*	Top Treatment
Lithium-ion Motors	Bliss™ 3.0 Li-Ion	32"	65"	D & E	All
	Sonesse® 40 WireFree™ RTS Li-Ion	31"	63"	D	
AC Motors	Bliss™ 10.0 AC	35"	NA	D & E	Open Roll, Fabric Cornice, and 4" Fascia
	Sonesse® 50 RTS AC (120V)	33"	NA	D & E	
	Sonesse® Ultra 50 AC (120V)	39"	NA	D & E	

*Not all fabrics are available in all zones

PRODUCT SIZE SPECIFICATIONS – CONTINUOUS LOOP CONTROL & AUTOMATION

Collection Code	Collection Name	Max Width Non-Railroaded ** (inches)	Max Width Railroaded (inches)	Available with Seam
R10	5% Sheerweave 5000 (01, 03, 07, 09, 10, 14, 15, 19)	98	168	Yes

**To determine the maximum width for continuous Fabric Cornices, subtract 4 inches from the maximum non-railroad width. Maximum height with Spring Assist on 4" Fascia is 120"

· Railroad Fabrics (turned width for length) will have a visible seam when fabricated longer than the maximum roll width less 16".
 · Red Box in spec chart indicates shade sizes Heat Sealed Hem Bar is recommended. For Continuous Loop Control, metal chain is also recommended for these sizes.

Top Treatment	Legend			
Medium Cassette				
3" Fascia				
Large Cassette				
Square Cassette				
Fabric Cornice				
4" Fascia				
Open Roll				

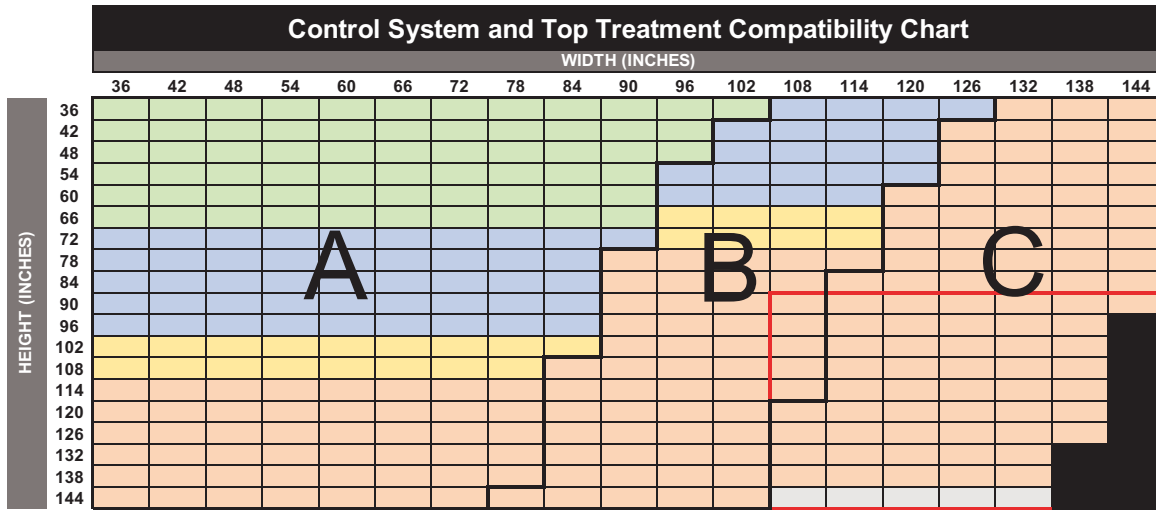

Control Systems (Minimum height for all Control Systems is 12")		Minimum Width (Single Panel)	Overall Minimum Width (2-on-1)	Specification Zone(s)*	Top Treatment
Continuous Loop Control	Continuous Loop Control (Maximum height for 12" width is 60")	12"	24"	A, B & C	All
	**Continuous Loop Control with Spring Assist	60"	NA	A, B & C	Open Roll & 4" Fascia
PowerWand	Powerwand 1.0 Li-Ion	21"	43"	A	All
	Powerwand 2.0 Li-Ion	22"	45"	A & B	(except 3" Fascia)
Lithium-ion Motors	Bliss™ 1.1 Li-Ion	21 1/2"	44"	A	All
	Bliss™ 2.0 Li-Ion	29"	59"	A & B	
	Sonesse® 28 WireFree™ RTS Li-Ion / Sonesse® 28 WireFree™ Zigbee Li-Ion	24 1/2"	50"	A	
	Sonesse® ULTRA 30 WireFree™ RTS Li-Ion	28 1/2"	58"	A & B	
DC Motors	Bliss™ 1.1 DC	16 1/2"	34"	A	All
	Bliss™ 2.0 DC	22 1/2"	46"	A & B	
	Sonesse® 28 WireFree™ RTS DC / Sonesse® 28 WireFree™ Zigbee DC	16 1/2"	34"	A	
	Sonesse® 30 RTS 24v DC	21"	NA	A & B	

**See Spring Assist Section in reference guide for details

*Not all fabrics are available in all zones

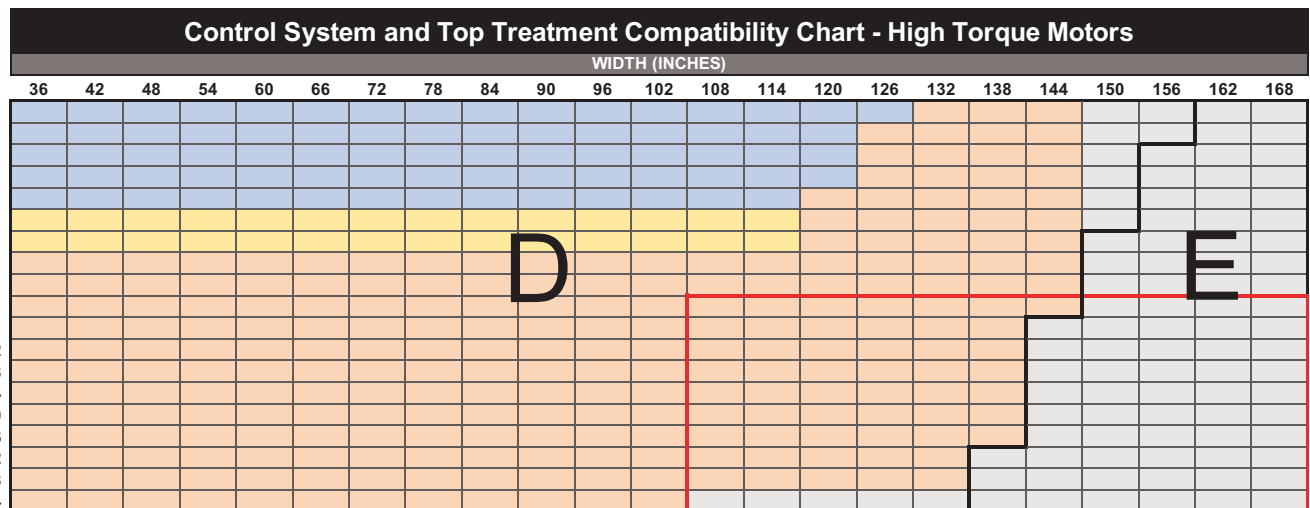

Control Systems (Minimum height for all Control Systems is 12")		Minimum Width (Single Panel)	Overall Minimum Width (2-on-1)	Specification Zone(s)*	Top Treatment
Lithium-ion Motors	Bliss™ 3.0 Li-Ion	32"	65"	D & E	All
	Sonesse® 40 WireFree™ RTS Li-Ion	31"	63"	D	
AC Motors	Bliss™ 10.0 AC	35"	NA	D & E	Open Roll, Fabric Cornice, and 4" Fascia
	Sonesse® 50 RTS AC (120V)	33"	NA	D & E	
	Sonesse® Ultra 50 AC (120V)	39"	NA	D & E	

*Not all fabrics are available in all zones

PRODUCT SIZE SPECIFICATIONS – CONTINUOUS LOOP CONTROL & AUTOMATION

Collection Code	Collection Name	Max Width Non-Railroaded ** (inches)	Max Width Railroaded (inches)	Available with Seam
AS007	5% Spectra Screen	118	168	Yes

**To determine the maximum width for continuous Fabric Cornices, subtract 4 inches from the maximum non-railroad width.

- Railroad Fabrics (turned width for length) will have a visible seam when fabricated longer than the maximum roll width less 16".
- Red Box in spec chart indicates shade sizes Heat Sealed Hem Bar is recommended. For Continuous Loop Control, metal chain is also recommended for these sizes.

Top Treatment	Legend			
Medium Cassette				
3" Fascia				
Large Cassette				
Square Cassette				
Fabric Cornice				
4" Fascia				
Open Roll				

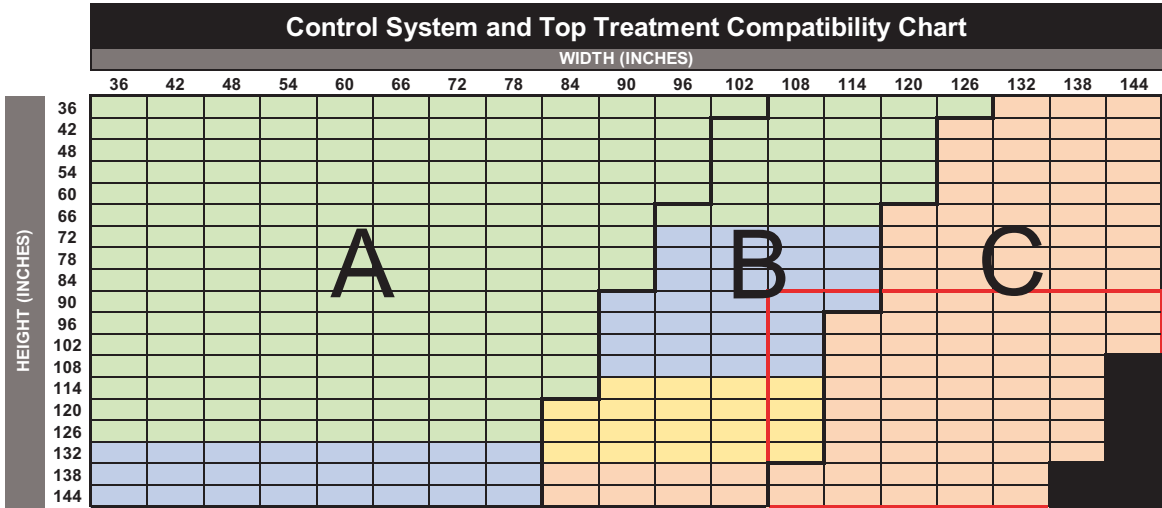

Control Systems (Minimum height for all Control Systems is 12")		Minimum Width (Single Panel)	Overall Minimum Width (2-on-1)	Specification Zone(s)*	Top Treatment
Continuous Loop Control	Continuous Loop Control (Maximum height for 12" width is 60")	12"	24"	A, B & C	All
	**Continuous Loop Control with Spring Assist	60"	NA	A, B & C	Open Roll & 4" Fascia
PowerWand	Powerwand 1.0 Li-Ion	21"	43"	A	All
	Powerwand 2.0 Li-Ion	22"	45"	A & B	(except 3" Fascia)
Lithium-ion Motors	Bliss™ 1.1 Li-Ion	21 1/2"	44"	A	All
	Bliss™ 2.0 Li-Ion	29"	59"	A & B	
	Sonessé® 28 WireFree™ RTS Li-Ion / Sonessé® 28 WireFree™ Zigbee Li-Ion	24 1/2"	50"	A	
	Sonessé® ULTRA 30 WireFree™ RTS Li-Ion	28 1/2"	58"	A & B	
DC Motors	Bliss™ 1.1 DC	16 1/2"	34"	A	All
	Bliss™ 2.0 DC	22 1/2"	46"	A & B	
	Sonessé® 28 WireFree™ RTS DC / Sonessé® 28 WireFree™ Zigbee DC	16 1/2"	34"	A	
	Sonessé® 30 RTS 24v DC	21"	NA	A & B	

**See Spring Assist Section in reference guide for details

*Not all fabrics are available in all zones

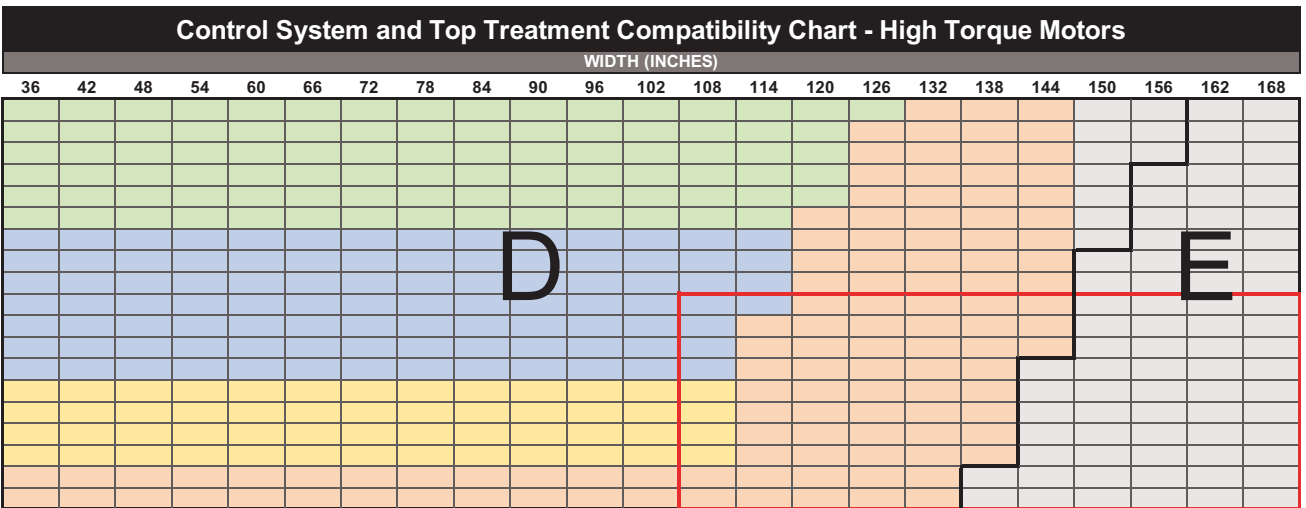

Control Systems (Minimum height for all Control Systems is 12")		Minimum Width (Single Panel)	Overall Minimum Width (2-on-1)	Specification Zone(s)*	Top Treatment
Lithium-ion Motors	Bliss™ 3.0 Li-Ion	32"	65"	D & E	All
	Sonessé® 40 WireFree™ RTS Li-Ion	31"	63"	D	
AC Motors	Bliss™ 10.0 AC	35"	NA	D & E	Open Roll, Fabric Cornice, and 4" Fascia
	Sonessé® 50 RTS AC (120V)	33"	NA	D & E	
	Sonessé® Ultra 50 AC (120V)	39"	NA	D & E	

*Not all fabrics are available in all zones

PRODUCT SIZE SPECIFICATIONS – CONTINUOUS LOOP CONTROL & AUTOMATION

Collection Code	Collection Name	Max Width Non-Railroaded ** (inches)	Max Width Railroaded (inches)	Available with Seam
AS005	5% Willow Screen	118	168	Yes

**To determine the maximum width for continuous Fabric Cornices, subtract 4 inches from the maximum non-railroad width.

- Railroad Fabrics (turned width for length) will have a visible seam when fabricated longer than the maximum roll width less 16".
- Red Box in spec chart indicates shade sizes Heat Sealed Hem Bar is recommended. For Continuous Loop Control, metal chain is also recommended for these sizes.

Top Treatment	Legend			
Medium Cassette				
3" Fascia				
Large Cassette				
Square Cassette				
Fabric Cornice				
4" Fascia				
Open Roll				

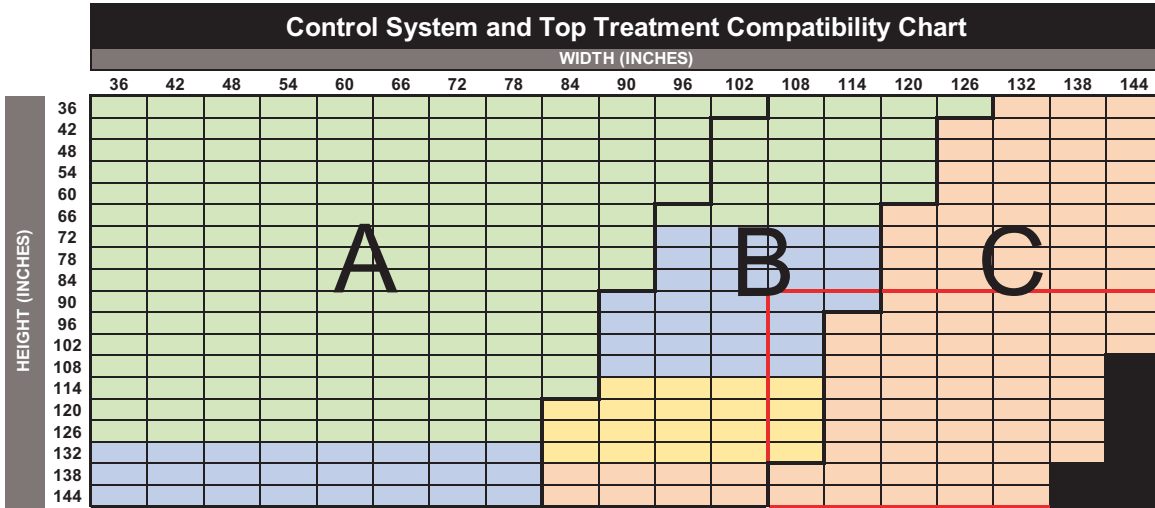

Control Systems (Minimum height for all Control Systems is 12")		Minimum Width (Single Panel)	Overall Minimum Width (2-on-1)	Specification Zone(s)*	Top Treatment
Continuous Loop Control	Continuous Loop Control (Maximum height for 12" width is 60")	12"	24"	A, B & C	All
	**Continuous Loop Control with Spring Assist	60"	NA	A, B & C	Open Roll & 4" Fascia
PowerWand	Powerwand 1.0 Li-Ion	21"	43"	A	All
	Powerwand 2.0 Li-Ion	22"	45"	A & B	(except 3" Fascia)
Lithium-ion Motors	Bliss™ 1.1 Li-Ion	21 1/2"	44"	A	All
	Bliss™ 2.0 Li-Ion	29"	59"	A & B	
	Sonessé® 28 WireFree™ RTS Li-Ion / Sonessé® 28 WireFree™ Zigbee Li-Ion	24 1/2"	50"	A	
	Sonessé® ULTRA 30 WireFree™ RTS Li-Ion	28 1/2"	58"	A & B	
DC Motors	Bliss™ 1.1 DC	16 1/2"	34"	A	All
	Bliss™ 2.0 DC	22 1/2"	46"	A & B	
	Sonessé® 28 WireFree™ RTS DC / Sonessé® 28 WireFree™ Zigbee DC	16 1/2"	34"	A	
	Sonessé® 30 RTS 24v DC	21"	NA	A & B	

**See Spring Assist Section in reference guide for details

*Not all fabrics are available in all zones

Control System and Top Treatment Compatibility Chart - High Torque Motors

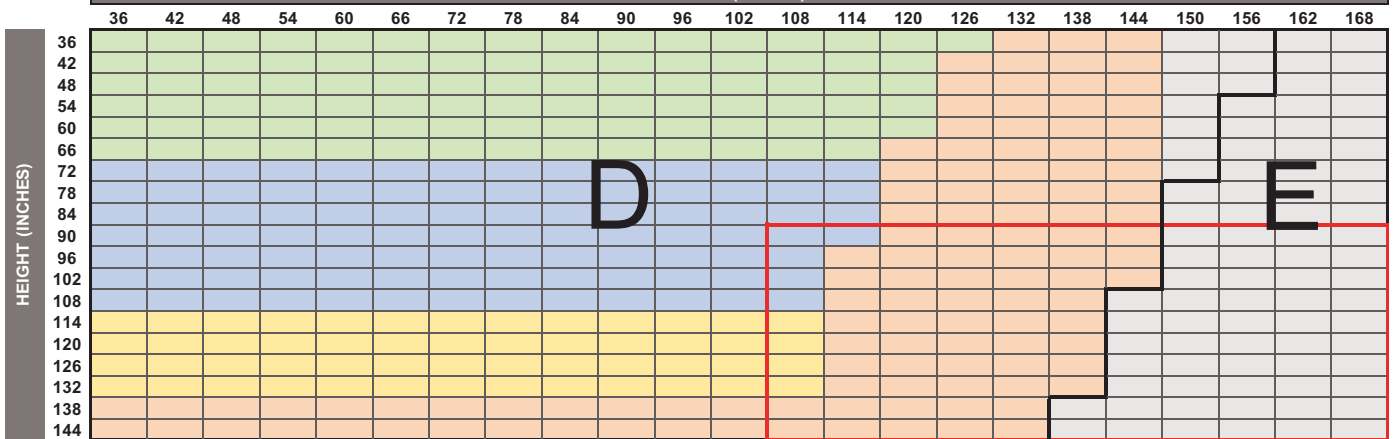

Control Systems (Minimum height for all Control Systems is 12")		Minimum Width (Single Panel)	Overall Minimum Width (2-on-1)	Specification Zone(s)*	Top Treatment
Lithium-ion Motors	Bliss™ 3.0 Li-Ion	32"	65"	D & E	All
	Sonessé® 40 WireFree™ RTS Li-Ion	31"	63"	D	
AC Motors	Bliss™ 10.0 AC	35"	NA	D & E	Open Roll, Fabric Cornice, and 4" Fascia
	Sonessé® 50 RTS AC (120V)	33"	NA	D & E	
	Sonessé® Ultra 50 AC (120V)	39"	NA	D & E	

*Not all fabrics are available in all zones

PRODUCT SIZE SPECIFICATIONS – CONTINUOUS LOOP CONTROL & AUTOMATION

Collection Code	Collection Name	Max Width Non-Railroaded ** (inches)	Max Width Railroaded (inches)	Available with Seam
R34	7% Sheerweave 5000 (08)	98	168	Yes

**To determine the maximum width for continuous Fabric Cornices, subtract 4 inches from the maximum non-railroad width.

- Railroad Fabrics (turned width for length) will have a visible seam when fabricated longer than the maximum roll width less 16".
- Red Box in spec chart indicates shade sizes Heat Sealed Hem Bar is recommended. For Continuous Loop Control, metal chain is also recommended for these sizes.

Top Treatment	Legend			
Medium Cassette				
3" Fascia				
Large Cassette				
Square Cassette				
Fabric Cornice				
4" Fascia				
Open Roll				

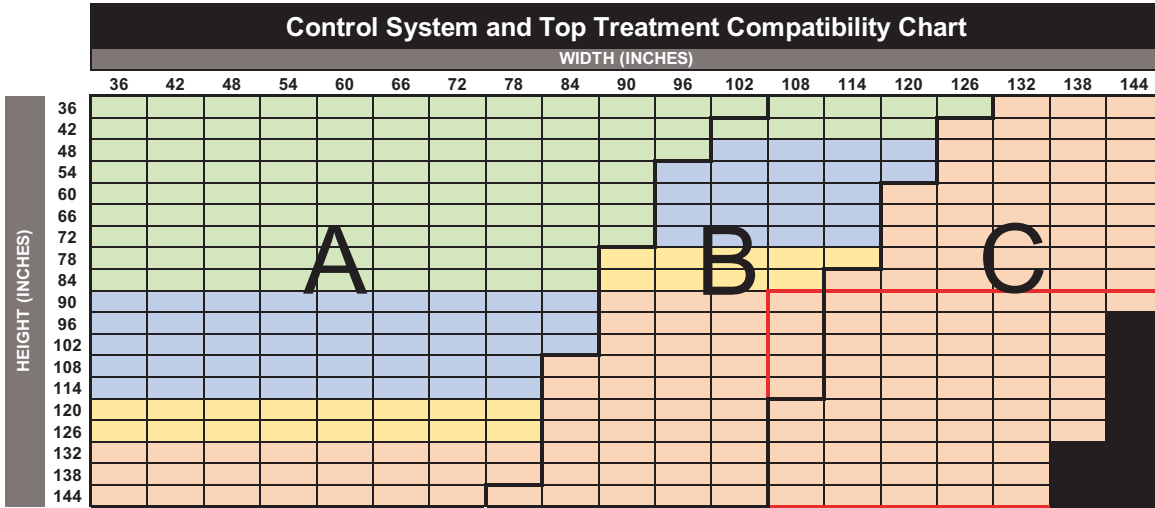

Control Systems (Minimum height for all Control Systems is 12")		Minimum Width (Single Panel)	Overall Minimum Width (2-on-1)	Specification Zone(s)*	Top Treatment
Continuous Loop Control	Continuous Loop Control (Maximum height for 12" width is 60")	12"	24"	A, B & C	All
	**Continuous Loop Control with Spring Assist	60"	NA	A, B & C	Open Roll & 4" Fascia
PowerWand	Powerwand 1.0 Li-Ion	21"	43"	A	All
	Powerwand 2.0 Li-Ion	22"	45"	A & B	(except 3" Fascia)
Lithium-ion Motors	Bliss™ 1.1 Li-Ion	21 1/2"	44"	A	All
	Bliss™ 2.0 Li-Ion	29"	59"	A & B	
	Sonesse® 28 WireFree™ RTS Li-Ion / Sonesse® 28 WireFree™ Zigbee Li-Ion	24 1/2"	50"	A	
	Sonesse® ULTRA 30 WireFree™ RTS Li-Ion	28 1/2"	58"	A & B	
DC Motors	Bliss™ 1.1 DC	16 1/2"	34"	A	All
	Bliss™ 2.0 DC	22 1/2"	46"	A & B	
	Sonesse® 28 WireFree™ RTS DC / Sonesse® 28 WireFree™ Zigbee DC	16 1/2"	34"	A	
	Sonesse® 30 RTS 24v DC	21"	NA	A & B	

**See Spring Assist Section in reference guide for details

*Not all fabrics are available in all zones

Control System and Top Treatment Compatibility Chart - High Torque Motors

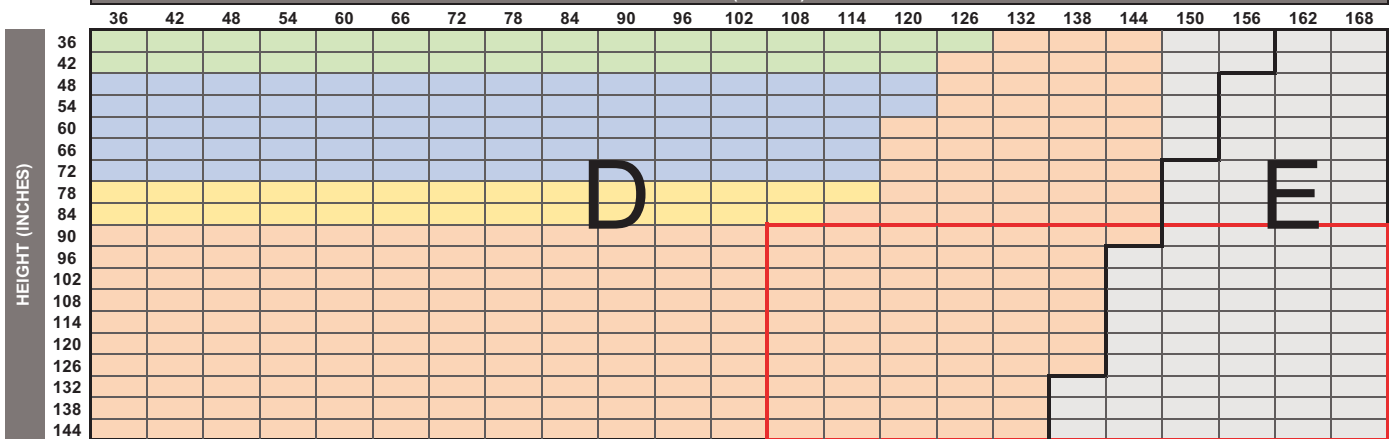

Control Systems (Minimum height for all Control Systems is 12")		Minimum Width (Single Panel)	Overall Minimum Width (2-on-1)	Specification Zone(s)*	Top Treatment
Lithium-ion Motors	Bliss™ 3.0 Li-Ion	32"	65"	D & E	All
	Sonesse® 40 WireFree™ RTS Li-Ion	31"	63"	D	
AC Motors	Bliss™ 10.0 AC	35"	NA	D & E	Open Roll, Fabric Cornice, and 4" Fascia
	Sonesse® 50 RTS AC (120V)	33"	NA	D & E	
	Sonesse® Ultra 50 AC (120V)	39"	NA	D & E	

*Not all fabrics are available in all zones

PRODUCT SIZE SPECIFICATIONS – CONTINUOUS LOOP CONTROL & AUTOMATION

Collection Code	Collection Name	Max Width Non-Railroaded ** (inches)	Max Width Railroaded (inches)	Available with Seam
R34	7% Sheerweave 5000 (Q46)	98	168	Yes

**To determine the maximum width for continuous Fabric Cornices, subtract 4 inches from the maximum non-railroad width. Maximum height with Spring Assist on 4" Fascia is 120"

· Railroad Fabrics (turned width for length) will have a visible seam when fabricated longer than the maximum roll width less 16".
· Red Box in spec chart indicates shade sizes Heat Sealed Hem Bar is recommended. For Continuous Loop Control, metal chain is also recommended for these sizes.

Top Treatment	Legend			
Medium Cassette				
3" Fascia				
Large Cassette				
Square Cassette				
Fabric Cornice				
4" Fascia				
Open Roll				

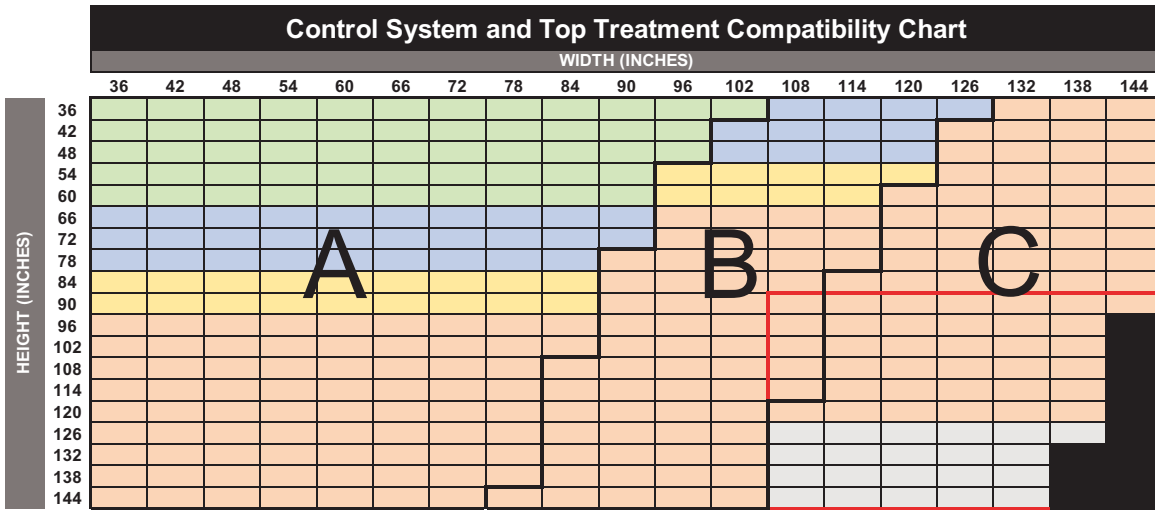

Control Systems (Minimum height for all Control Systems is 12")		Minimum Width (Single Panel)	Overall Minimum Width (2-on-1)	Specification Zone(s)*	Top Treatment
Continuous Loop Control	Continuous Loop Control (Maximum height for 12" width is 60")	12"	24"	A, B & C	All
	**Continuous Loop Control with Spring Assist	60"	NA	A, B & C	Open Roll & 4" Fascia
PowerWand	Powerwand 1.0 Li-Ion	21"	43"	A	All
	Powerwand 2.0 Li-Ion	22"	45"	A & B	(except 3" Fascia)
Lithium-ion Motors	Bliss™ 1.1 Li-Ion	21 1/2"	44"	A	All
	Bliss™ 2.0 Li-Ion	29"	59"	A & B	
	Sonesse® 28 WireFree™ RTS Li-Ion / Sonesse® 28 WireFree™ Zigbee Li-Ion	24 1/2"	50"	A	
	Sonesse® ULTRA 30 WireFree™ RTS Li-Ion	28 1/2"	58"	A & B	
DC Motors	Bliss™ 1.1 DC	16 1/2"	34"	A	All
	Bliss™ 2.0 DC	22 1/2"	46"	A & B	
	Sonesse® 28 WireFree™ RTS DC / Sonesse® 28 WireFree™ Zigbee DC	16 1/2"	34"	A	
	Sonesse® 30 RTS 24v DC	21"	NA	A & B	

**See Spring Assist Section in reference guide for details

*Not all fabrics are available in all zones

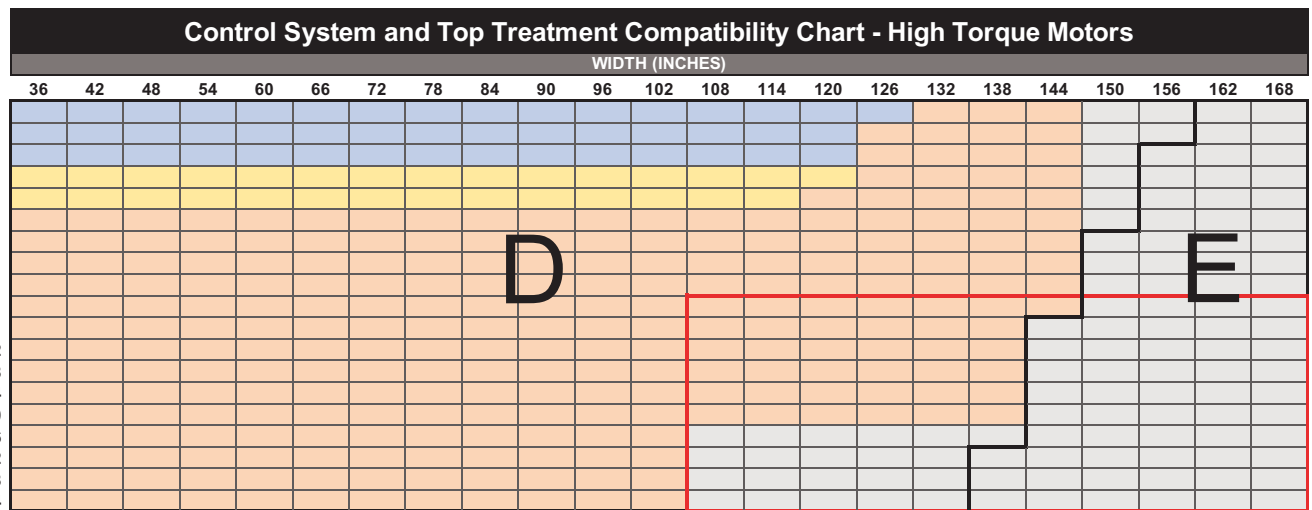

Control Systems (Minimum height for all Control Systems is 12")		Minimum Width (Single Panel)	Overall Minimum Width (2-on-1)	Specification Zone(s)*	Top Treatment
Lithium-ion Motors	Bliss™ 3.0 Li-Ion	32"	65"	D & E	All
	Sonesse® 40 WireFree™ RTS Li-Ion	31"	63"	D	
AC Motors	Bliss™ 10.0 AC	35"	NA	D & E	Open Roll, Fabric Cornice, and 4" Fascia
	Sonesse® 50 RTS AC (120V)	33"	NA	D & E	
	Sonesse® Ultra 50 AC (120V)	39"	NA	D & E	

*Not all fabrics are available in all zones

PRODUCT SIZE SPECIFICATIONS – CONTINUOUS LOOP CONTROL & AUTOMATION

Collection Code	Collection Name	Max Width Non-Railroaded ** (inches)	Max Width Railroaded (inches)	Available with Seam
R19	10% E Screen	122	168	Yes

**To determine the maximum width for continuous Fabric Cornices, subtract 4 inches from the maximum non-railroad width.

- Railroad Fabrics (turned width for length) will have a visible seam when fabricated longer than the maximum roll width less 16".
- Red Box in spec chart indicates shade sizes Heat Sealed Hem Bar is recommended. For Continuous Loop Control, metal chain is also recommended for these sizes.

Top Treatment	Legend			
Medium Cassette				
3" Fascia				
Large Cassette				
Square Cassette				
Fabric Cornice				
4" Fascia				
Open Roll				

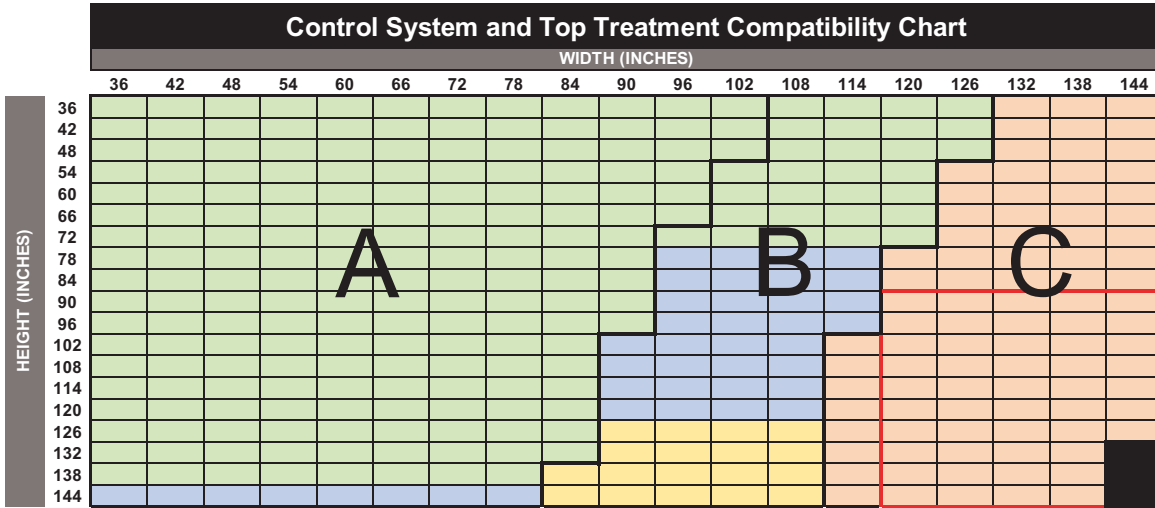

Control Systems (Minimum height for all Control Systems is 12")		Minimum Width (Single Panel)	Overall Minimum Width (2-on-1)	Specification Zone(s)*	Top Treatment
Continuous Loop Control	Continuous Loop Control (Maximum height for 12" width is 60")	12"	24"	A, B & C	All
	**Continuous Loop Control with Spring Assist	60"	NA	A, B & C	Open Roll & 4" Fascia
PowerWand	Powerwand 1.0 Li-Ion	21"	43"	A	All
	Powerwand 2.0 Li-Ion	22"	45"	A & B	(except 3" Fascia)
Lithium-ion Motors	Bliss™ 1.1 Li-Ion	21 1/2"	44"	A	All
	Bliss™ 2.0 Li-Ion	29"	59"	A & B	
	Sonessé® 28 WireFree™ RTS Li-Ion / Sonessé® 28 WireFree™ Zigbee Li-Ion	24 1/2"	50"	A	
	Sonessé® ULTRA 30 WireFree™ RTS Li-Ion	28 1/2"	58"	A & B	
DC Motors	Bliss™ 1.1 DC	16 1/2"	34"	A	All
	Bliss™ 2.0 DC	22 1/2"	46"	A & B	
	Sonessé® 28 WireFree™ RTS DC / Sonessé® 28 WireFree™ Zigbee DC	16 1/2"	34"	A	
	Sonessé® 30 RTS 24v DC	21"	NA	A & B	

**See Spring Assist Section in reference guide for details

*Not all fabrics are available in all zones

Control System and Top Treatment Compatibility Chart - High Torque Motors

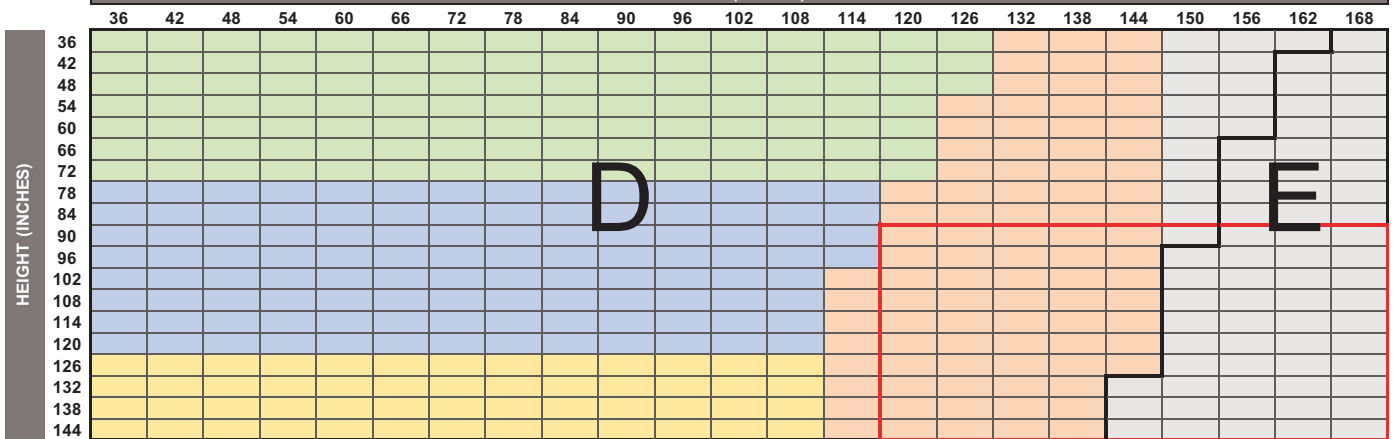

Control Systems (Minimum height for all Control Systems is 12")		Minimum Width (Single Panel)	Overall Minimum Width (2-on-1)	Specification Zone(s)*	Top Treatment
Lithium-ion Motors	Bliss™ 3.0 Li-Ion	32"	65"	D & E	All
	Sonessé® 40 WireFree™ RTS Li-Ion	31"	63"	D	
AC Motors	Bliss™ 10.0 AC	35"	NA	D & E	Open Roll, Fabric Cornice, and 4" Fascia
	Sonessé® 50 RTS AC (120V)	33"	NA	D & E	
	Sonessé® Ultra 50 AC (120V)	39"	NA	D & E	

*Not all fabrics are available in all zones

PRODUCT SIZE SPECIFICATIONS – CONTINUOUS LOOP CONTROL & AUTOMATION

Collection Code	Collection Name	Max Width Non-Railroaded ** (inches)	Max Width Railroaded (inches)	Available with Seam
P2360	10% Sheerweave 2360	126	168	Yes

**To determine the maximum width for continuous Fabric Cornices, subtract 4 inches from the maximum non-railroad width.

- Railroad Fabrics (turned width for length) will have a visible seam when fabricated longer than the maximum roll width less 16".
- Red Box in spec chart indicates shade sizes Heat Sealed Hem Bar is recommended. For Continuous Loop Control, metal chain is also recommended for these sizes.

Top Treatment	Legend			
Medium Cassette	Green	Blue	Yellow	Orange
3" Fascia	Green	Blue	Yellow	Orange
Large Cassette	Green	Blue	Yellow	Orange
Square Cassette	Green	Blue	Yellow	Orange
Fabric Cornice	Green	Blue	Yellow	Orange
4" Fascia	Green	Blue	Yellow	Orange
Open Roll	Green	Blue	Yellow	Orange

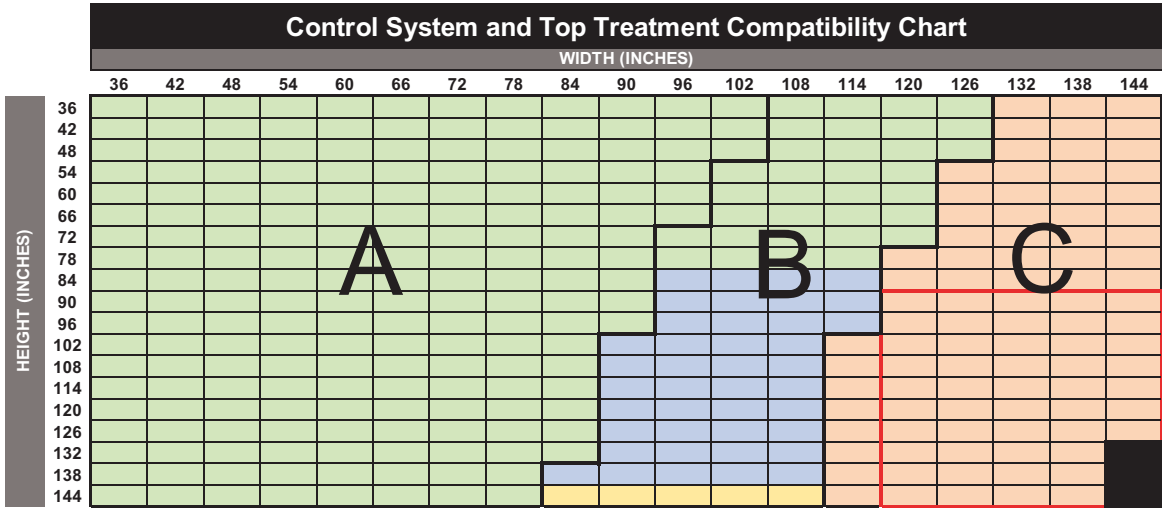

Control Systems (Minimum height for all Control Systems is 12")		Minimum Width (Single Panel)	Overall Minimum Width (2-on-1)	Specification Zone(s)*	Top Treatment
Continuous Loop Control	Continuous Loop Control (Maximum height for 12" width is 60")	12"	24"	A, B & C	All
	**Continuous Loop Control with Spring Assist	60"	NA	A, B & C	Open Roll & 4" Fascia
PowerWand	Powerwand 1.0 Li-Ion	21"	43"	A	All
	Powerwand 2.0 Li-Ion	22"	45"	A & B	(except 3" Fascia)
Lithium-ion Motors	Bliss™ 1.1 Li-Ion	21 1/2"	44"	A	All
	Bliss™ 2.0 Li-Ion	29"	59"	A & B	
	Sonessé® 28 WireFree™ RTS Li-Ion / Sonessé® 28 WireFree™ Zigbee Li-Ion	24 1/2"	50"	A	
	Sonessé® ULTRA 30 WireFree™ RTS Li-Ion	28 1/2"	58"	A & B	
DC Motors	Bliss™ 1.1 DC	16 1/2"	34"	A	All
	Bliss™ 2.0 DC	22 1/2"	46"	A & B	
	Sonessé® 28 WireFree™ RTS DC / Sonessé® 28 WireFree™ Zigbee DC	16 1/2"	34"	A	
	Sonessé® 30 RTS 24v DC	21"	NA	A & B	

**See Spring Assist Section in reference guide for details

*Not all fabrics are available in all zones

Control System and Top Treatment Compatibility Chart - High Torque Motors

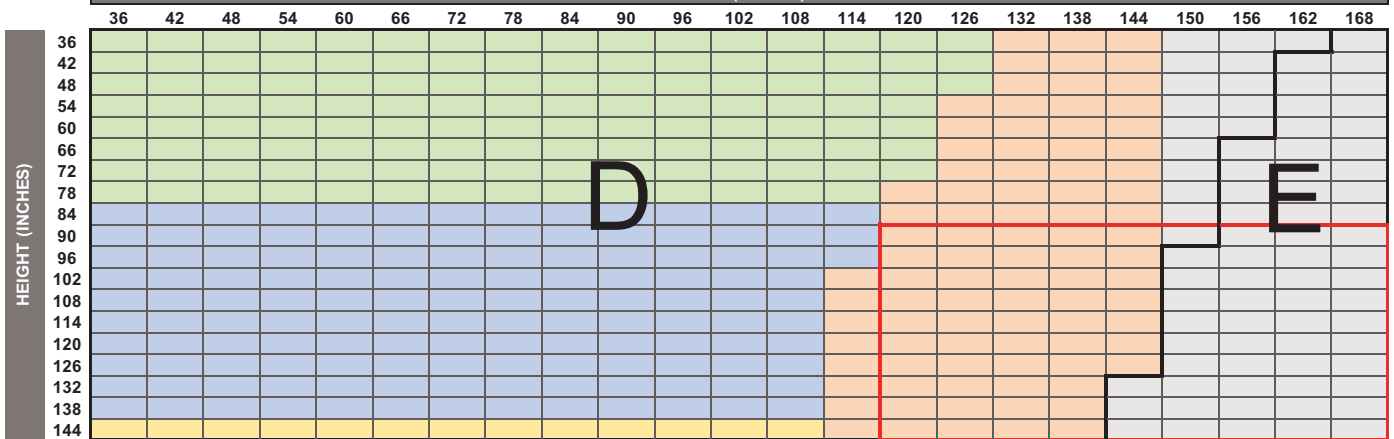

Control Systems (Minimum height for all Control Systems is 12")		Minimum Width (Single Panel)	Overall Minimum Width (2-on-1)	Specification Zone(s)*	Top Treatment
Lithium-ion Motors	Bliss™ 3.0 Li-Ion	32"	65"	D & E	All
	Sonessé® 40 WireFree™ RTS Li-Ion	31"	63"	D	
AC Motors	Bliss™ 10.0 AC	35"	NA	D & E	Open Roll, Fabric Cornice, and 4" Fascia
	Sonessé® 50 RTS AC (120V)	33"	NA	D & E	
	Sonessé® Ultra 50 AC (120V)	39"	NA	D & E	

*Not all fabrics are available in all zones

PRODUCT SIZE SPECIFICATIONS – CONTINUOUS LOOP CONTROL & AUTOMATION

Collection Code	Collection Name	Max Width Non-Railroaded ** (inches)	Max Width Railroaded (inches)	Available with Seam
P4100	10% Sheerweave 4100	98	168	Yes

**To determine the maximum width for continuous Fabric Cornices, subtract 4 inches from the maximum non-railroad width.

- Railroad Fabrics (turned width for length) will have a visible seam when fabricated longer than the maximum roll width less 16".
- Red Box in spec chart indicates shade sizes Heat Sealed Hem Bar is recommended. For Continuous Loop Control, metal chain is also recommended for these sizes.

Top Treatment	Legend			
Medium Cassette				
3" Fascia				
Large Cassette				
Square Cassette				
Fabric Cornice				
4" Fascia				
Open Roll				

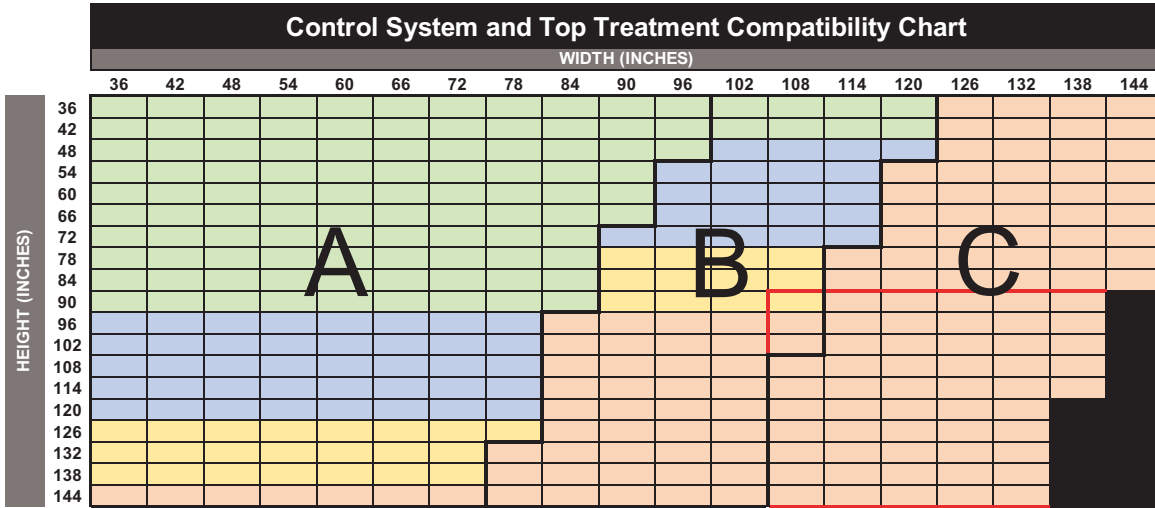

Control Systems (Minimum height for all Control Systems is 12")		Minimum Width (Single Panel)	Overall Minimum Width (2-on-1)	Specification Zone(s)*	Top Treatment
Continuous Loop Control	Continuous Loop Control (Maximum height for 12" width is 60")	12"	24"	A, B & C	All
	**Continuous Loop Control with Spring Assist	60"	NA	A, B & C	Open Roll & 4" Fascia
PowerWand	Powerwand 1.0 Li-Ion	21"	43"	A	All
	Powerwand 2.0 Li-Ion	22"	45"	A & B	(except 3" Fascia)
Lithium-ion Motors	Bliss™ 1.1 Li-Ion	21 1/2"	44"	A	All
	Bliss™ 2.0 Li-Ion	29"	59"	A & B	
	Sonesse® 28 WireFree™ RTS Li-Ion / Sonesse® 28 WireFree™ Zigbee Li-Ion	24 1/2"	50"	A	
	Sonesse® ULTRA 30 WireFree™ RTS Li-Ion	28 1/2"	58"	A & B	
DC Motors	Bliss™ 1.1 DC	16 1/2"	34"	A	All
	Bliss™ 2.0 DC	22 1/2"	46"	A & B	
	Sonesse® 28 WireFree™ RTS DC / Sonesse® 28 WireFree™ Zigbee DC	16 1/2"	34"	A	
	Sonesse® 30 RTS 24v DC	21"	NA	A & B	

**See Spring Assist Section in reference guide for details

*Not all fabrics are available in all zones

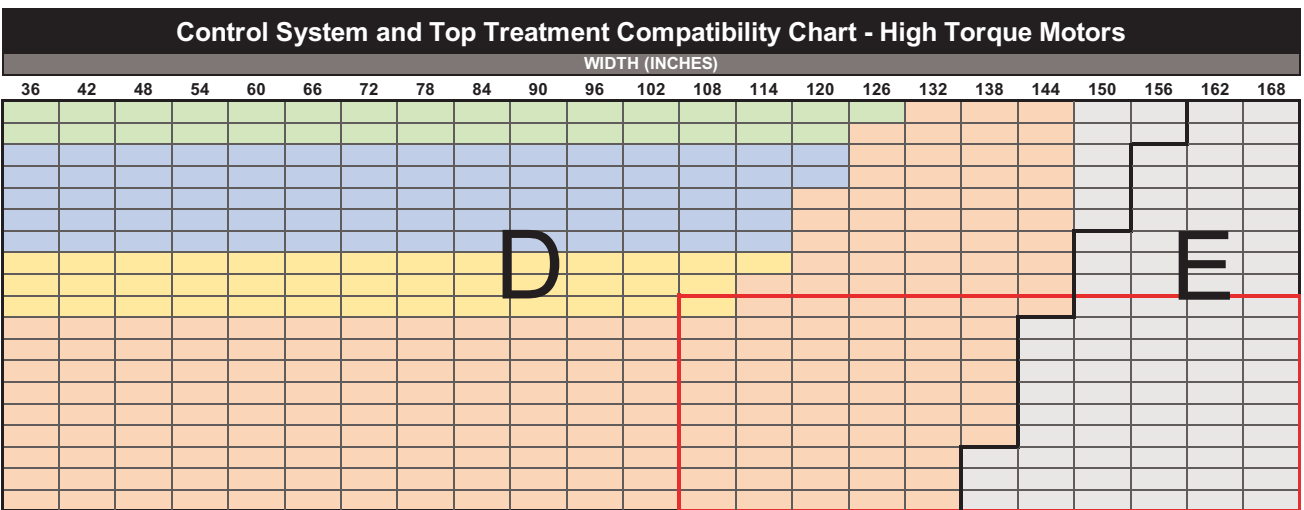

Control Systems (Minimum height for all Control Systems is 12")		Minimum Width (Single Panel)	Overall Minimum Width (2-on-1)	Specification Zone(s)*	Top Treatment
Lithium-ion Motors	Bliss™ 3.0 Li-Ion	32"	65"	D & E	All
	Sonesse® 40 WireFree™ RTS Li-Ion	31"	63"	D	
AC Motors	Bliss™ 10.0 AC	35"	NA	D & E	Open Roll, Fabric Cornice, and 4" Fascia
	Sonesse® 50 RTS AC (120V)	33"	NA	D & E	
	Sonesse® Ultra 50 AC (120V)	39"	NA	D & E	

*Not all fabrics are available in all zones

PRODUCT SIZE SPECIFICATIONS – CONTINUOUS LOOP CONTROL & AUTOMATION

Collection Code	Collection Name	Max Width Non-Railroaded ** (inches)	Max Width Railroaded (inches)	Available with Seam
R26	10% Sheerweave 5000 (U28, U24, U29)	98	168	Yes

**To determine the maximum width for continuous Fabric Cornices, subtract 4 inches from the maximum non-railroad width. Maximum height with Spring Assist on 4" Fascia is 132"

· Railroaded Fabrics (turned width for length) will have a visible seam when fabricated longer than the maximum roll width less 16".

· Red Box in spec chart indicates shade sizes Heat Sealed Hem Bar is recommended. For Continuous Loop Control, metal chain is also recommended for these sizes.

Top Treatment	Legend			
Medium Cassette				
3" Fascia				
Large Cassette				
Square Cassette				
Fabric Cornice				
4" Fascia				
Open Roll				

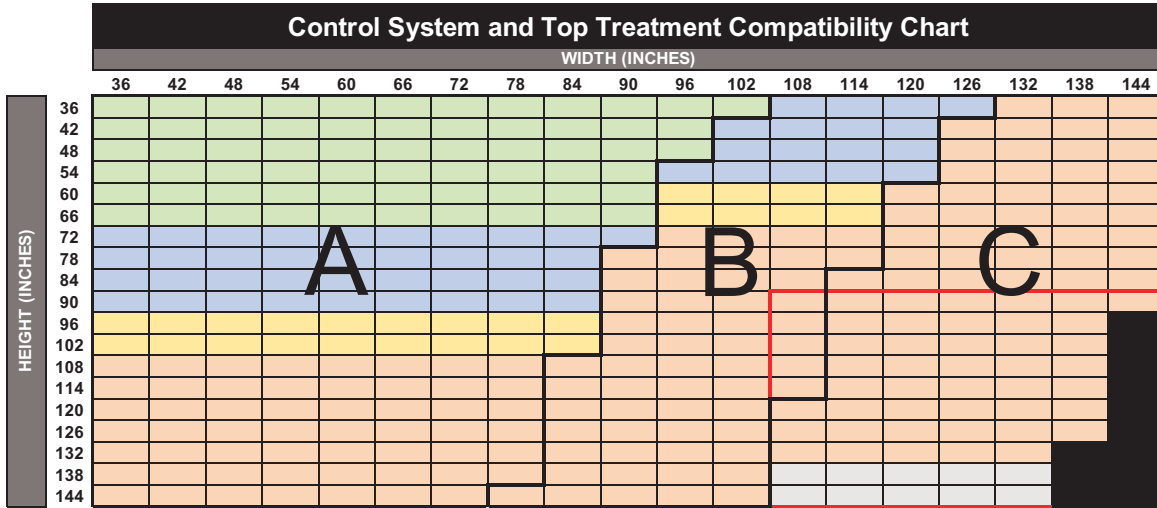

Control Systems (Minimum height for all Control Systems is 12")		Minimum Width (Single Panel)	Overall Minimum Width (2-on-1)	Specification Zone(s)*	Top Treatment
Continuous Loop Control	Continuous Loop Control (Maximum height for 12" width is 60")	12"	24"	A, B & C	All
	**Continuous Loop Control with Spring Assist	60"	NA	A, B & C	Open Roll & 4" Fascia
PowerWand	Powerwand 1.0 Li-Ion	21"	43"	A	All
	Powerwand 2.0 Li-Ion	22"	45"	A & B	(except 3" Fascia)
Lithium-ion Motors	Bliss™ 1.1 Li-Ion	21 1/2"	44"	A	All
	Bliss™ 2.0 Li-Ion	29"	59"	A & B	
	Sonesse® 28 WireFree™ RTS Li-Ion / Sonesse® 28 WireFree™ Zigbee Li-Ion	24 1/2"	50"	A	
	Sonesse® ULTRA 30 WireFree™ RTS Li-Ion	28 1/2"	58"	A & B	
DC Motors	Bliss™ 1.1 DC	16 1/2"	34"	A	All
	Bliss™ 2.0 DC	22 1/2"	46"	A & B	
	Sonesse® 28 WireFree™ RTS DC / Sonesse® 28 WireFree™ Zigbee DC	16 1/2"	34"	A	
	Sonesse® 30 RTS 24v DC	21"	NA	A & B	

**See Spring Assist Section in reference guide for details

*Not all fabrics are available in all zones

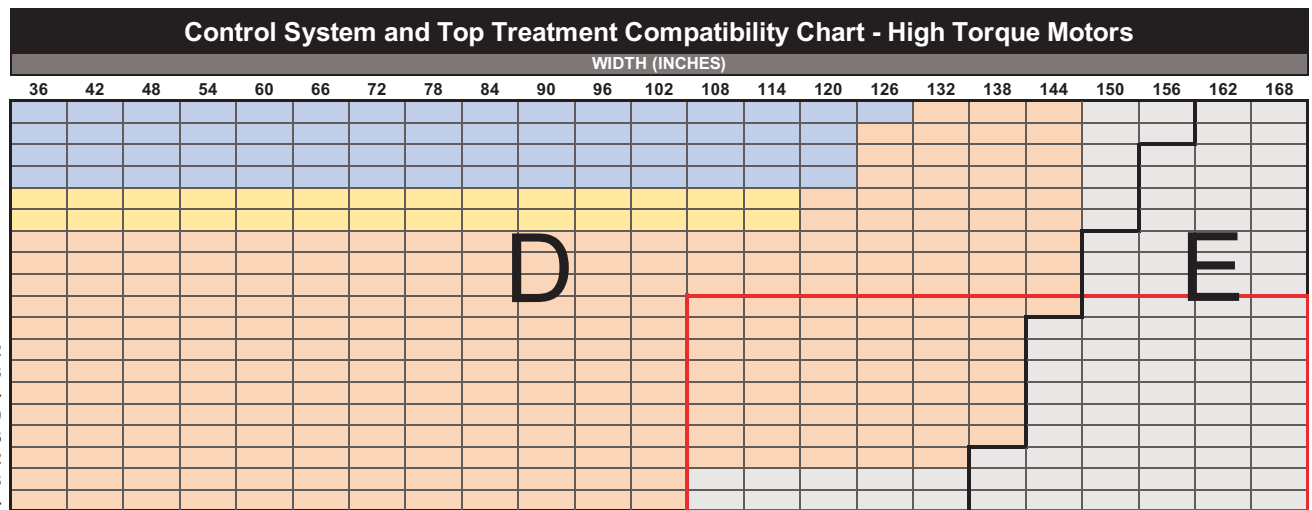

Control Systems (Minimum height for all Control Systems is 12")		Minimum Width (Single Panel)	Overall Minimum Width (2-on-1)	Specification Zone(s)*	Top Treatment
Lithium-ion Motors	Bliss™ 3.0 Li-Ion	32"	65"	D & E	All
	Sonesse® 40 WireFree™ RTS Li-Ion	31"	63"	D	
AC Motors	Bliss™ 10.0 AC	35"	NA	D & E	Open Roll, Fabric Cornice, and 4" Fascia
	Sonesse® 50 RTS AC (120V)	33"	NA	D & E	
	Sonesse® Ultra 50 AC (120V)	39"	NA	D & E	

*Not all fabrics are available in all zones

PRODUCT SIZE SPECIFICATIONS – CONTINUOUS LOOP CONTROL & AUTOMATION

Collection Code	Collection Name	Max Width Non-Railroaded ** (inches)	Max Width Railroaded (inches)	Available with Seam
AF034	Adelaide	118	NA	No

**To determine the maximum width for continuous Fabric Cornices, subtract 4 inches from the maximum non-railroad width.

- Railroad Fabrics (turned width for length) will have a visible seam when fabricated longer than the maximum roll width less 16".
- Red Box in spec chart indicates shade sizes Heat Sealed Hem Bar is recommended. For Continuous Loop Control, metal chain is also recommended for these sizes.

Top Treatment	Legend			
Medium Cassette				
3" Fascia				
Large Cassette				
Square Cassette				
Fabric Cornice				
4" Fascia				
Open Roll				

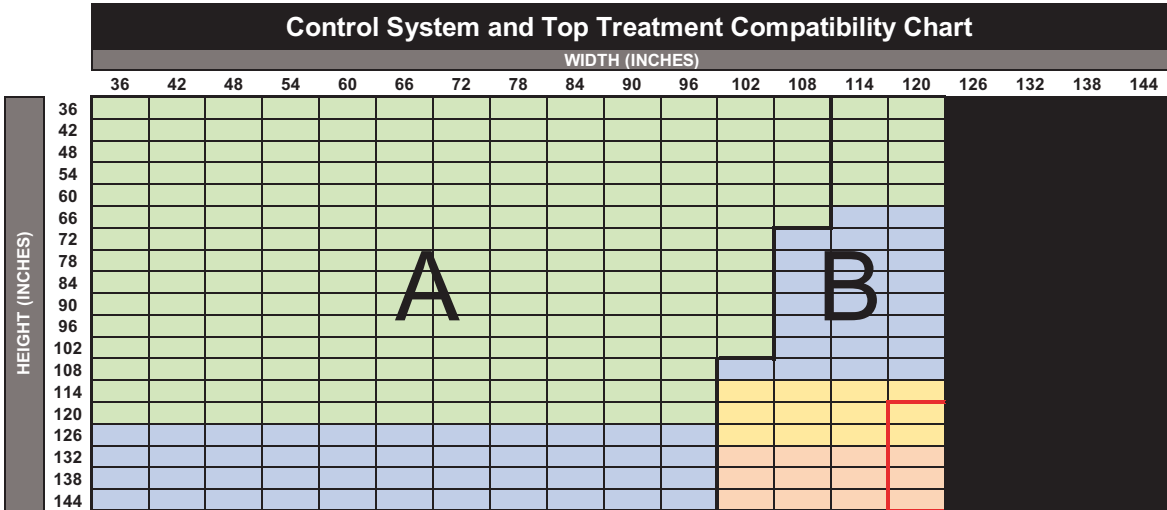

Control Systems (Minimum height for all Control Systems is 12")		Minimum Width (Single Panel)	Overall Minimum Width (2-on-1)	Specification Zone(s)*	Top Treatment
Continuous Loop Control	Continuous Loop Control (Maximum height for 12" width is 60")	12"	24"	A, B & C	All
	**Continuous Loop Control with Spring Assist	60"	NA	A, B & C	Open Roll & 4" Fascia
PowerWand	Powerwand 1.0 Li-Ion	21"	43"	A	All
	Powerwand 2.0 Li-Ion	22"	45"	A & B	(except 3" Fascia)
Lithium-ion Motors	Bliss™ 1.1 Li-Ion	21 1/2"	44"	A	All
	Bliss™ 2.0 Li-Ion	29"	59"	A & B	
	Sonessé® 28 WireFree™ RTS Li-Ion / Sonessé® 28 WireFree™ Zigbee Li-Ion	24 1/2"	50"	A	
	Sonessé® ULTRA 30 WireFree™ RTS Li-Ion	28 1/2"	58"	A & B	
DC Motors	Bliss™ 1.1 DC	16 1/2"	34"	A	All
	Bliss™ 2.0 DC	22 1/2"	46"	A & B	
	Sonessé® 28 WireFree™ RTS DC / Sonessé® 28 WireFree™ Zigbee DC	16 1/2"	34"	A	
	Sonessé® 30 RTS 24v DC	21"	NA	A & B	

**See Spring Assist Section in reference guide for details

*Not all fabrics are available in all zones

Control System and Top Treatment Compatibility Chart - High Torque Motors

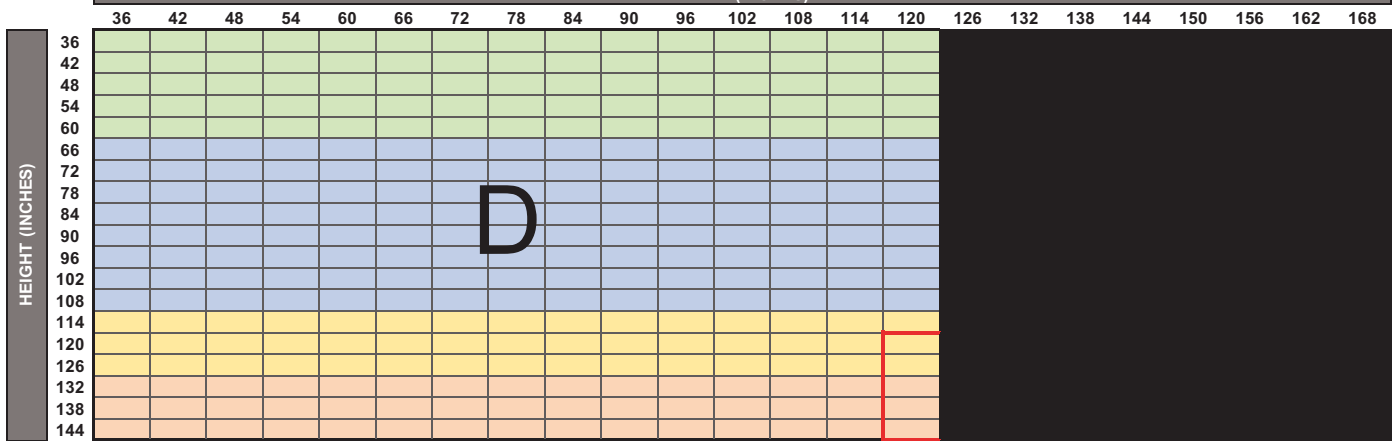

Control Systems (Minimum height for all Control Systems is 12")		Minimum Width (Single Panel)	Overall Minimum Width (2-on-1)	Specification Zone(s)*	Top Treatment
Lithium-ion Motors	Bliss™ 3.0 Li-Ion	32"	65"	D & E	All
	Sonessé® 40 WireFree™ RTS Li-Ion	31"	63"	D	
AC Motors	Bliss™ 10.0 AC	35"	NA	D & E	Open Roll, Fabric Cornice, and 4" Fascia
	Sonessé® 50 RTS AC (120V)	33"	NA	D & E	
	Sonessé® Ultra 50 AC (120V)	39"	NA	D & E	

*Not all fabrics are available in all zones

PRODUCT SIZE SPECIFICATIONS – CONTINUOUS LOOP CONTROL & AUTOMATION

Collection Code	Collection Name	Max Width Non-Railroaded ** (inches)	Max Width Railroaded (inches)	Available with Seam
AB034	Adelaide Blackout	114	NA	No

**To determine the maximum width for continuous Fabric Cornices, subtract 4 inches from the maximum non-railroad width.

· Railroad Fabrics (turned width for length) will have a visible seam when fabricated longer than the maximum roll width less 16".
 · Red Box in spec chart indicates shade sizes Heat Sealed Hem Bar is recommended. For Continuous Loop Control, metal chain is also recommended for these sizes.

Top Treatment	Legend			
Medium Cassette				
3" Fascia				
Large Cassette				
Square Cassette				
Fabric Cornice				
4" Fascia				
Open Roll				

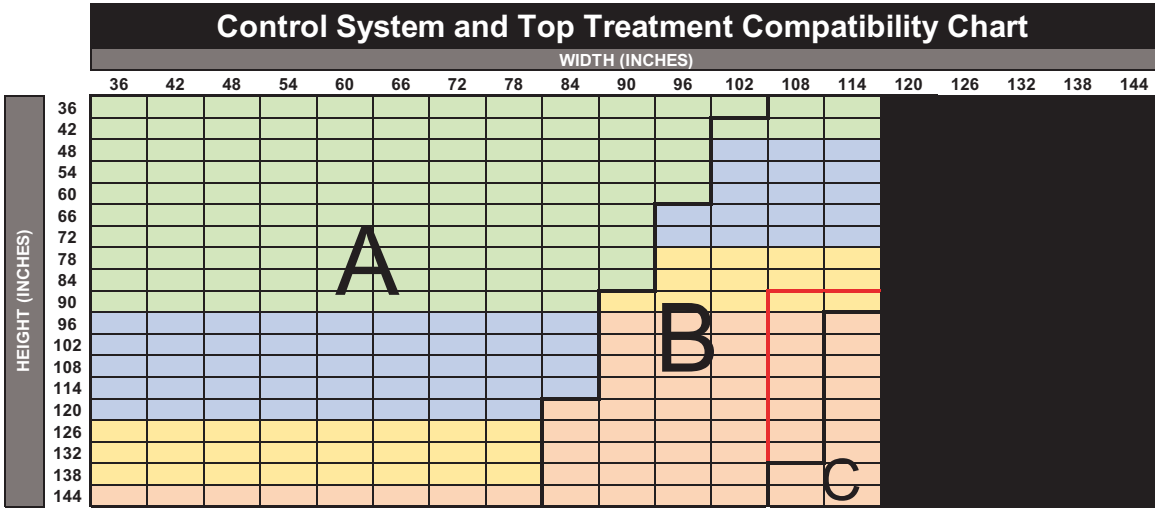

Control Systems (Minimum height for all Control Systems is 12")		Minimum Width (Single Panel)	Overall Minimum Width (2-on-1)	Specification Zone(s)*	Top Treatment
Continuous Loop Control	Continuous Loop Control (Maximum height for 12" width is 60")	12"	24"	A, B & C	All
	**Continuous Loop Control with Spring Assist	60"	NA	A, B & C	Open Roll & 4" Fascia
PowerWand	Powerwand 1.0 Li-Ion	21"	43"	A	All
	Powerwand 2.0 Li-Ion	22"	45"	A & B	(except 3" Fascia)
Lithium-ion Motors	Bliss™ 1.1 Li-Ion	21 1/2"	44"	A	All
	Bliss™ 2.0 Li-Ion	29"	59"	A & B	
	Sonessé® 28 WireFree™ RTS Li-Ion / Sonessé® 28 WireFree™ Zigbee Li-Ion	24 1/2"	50"	A	
	Sonessé® ULTRA 30 WireFree™ RTS Li-Ion	28 1/2"	58"	A & B	
DC Motors	Bliss™ 1.1 DC	16 1/2"	34"	A	All
	Bliss™ 2.0 DC	22 1/2"	46"	A & B	
	Sonessé® 28 WireFree™ RTS DC / Sonessé® 28 WireFree™ Zigbee DC	16 1/2"	34"	A	
	Sonessé® 30 RTS 24v DC	21"	NA	A & B	

**See Spring Assist Section in reference guide for details

*Not all fabrics are available in all zones

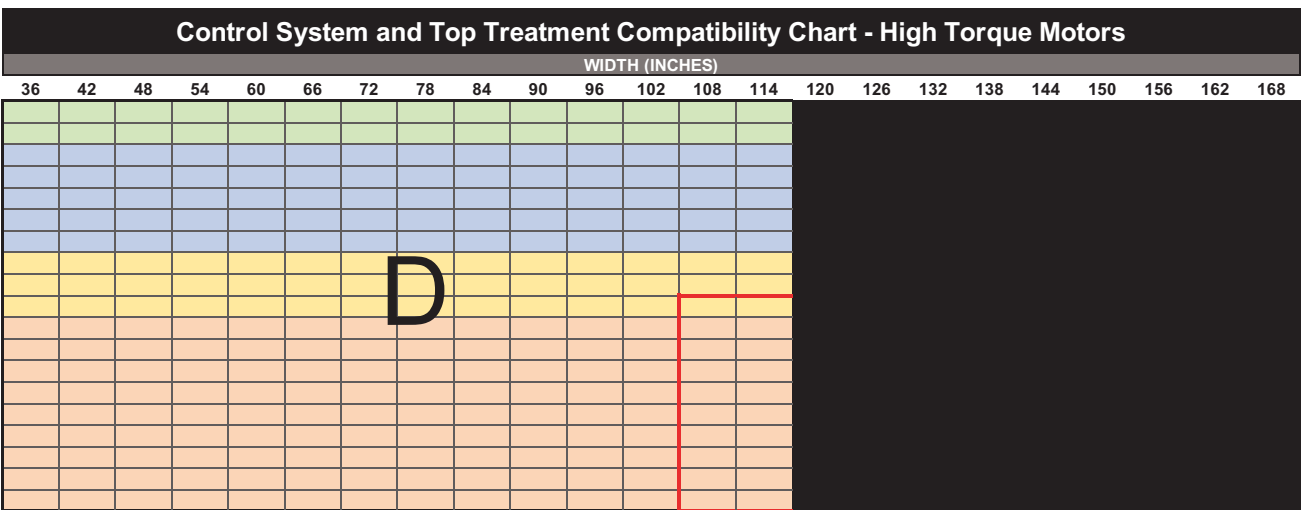

Control Systems (Minimum height for all Control Systems is 12")		Minimum Width (Single Panel)	Overall Minimum Width (2-on-1)	Specification Zone(s)*	Top Treatment
Lithium-ion Motors	Bliss™ 3.0 Li-Ion	32"	65"	D & E	All
	Sonessé® 40 WireFree™ RTS Li-Ion	31"	63"	D	
AC Motors	Bliss™ 10.0 AC	35"	NA	D & E	Open Roll, Fabric Cornice, and 4" Fascia
	Sonessé® 50 RTS AC (120V)	33"	NA	D & E	
	Sonessé® Ultra 50 AC (120V)	39"	NA	D & E	

*Not all fabrics are available in all zones

PRODUCT SIZE SPECIFICATIONS – CONTINUOUS LOOP CONTROL & AUTOMATION

Collection Code	Collection Name	Max Width Non-Railroaded ** (inches)	Max Width Railroaded (inches)	Available with Seam
AF016	Aegean	78 3/4	NA	No

**To determine the maximum width for continuous Fabric Cornices, subtract 4 inches from the maximum non-railroad width.

· Railroad Fabrics (turned width for length) will have a visible seam when fabricated longer than the maximum roll width less 16".
 · Red Box in spec chart indicates shade sizes Heat Sealed Hem Bar is recommended. For Continuous Loop Control, metal chain is also recommended for these sizes.

Top Treatment	Legend			
Medium Cassette				
3" Fascia				
Large Cassette				
Square Cassette				
Fabric Cornice				
4" Fascia				
Open Roll				

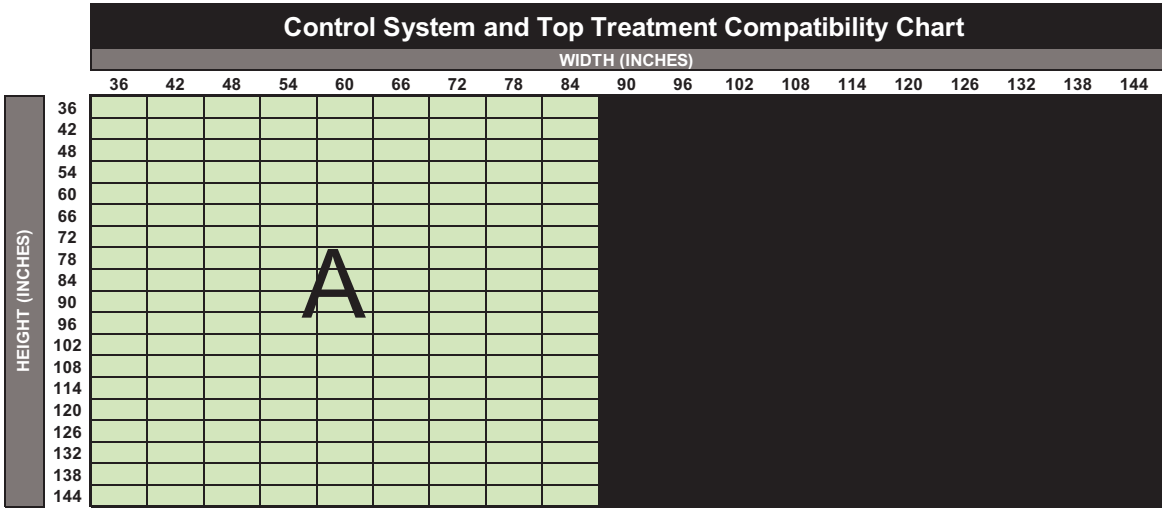

Control Systems (Minimum height for all Control Systems is 12")		Minimum Width (Single Panel)	Overall Minimum Width (2-on-1)	Specification Zone(s)*	Top Treatment
Continuous Loop Control	Continuous Loop Control (Maximum height for 12" width is 60")	12"	24"	A, B & C	All
	**Continuous Loop Control with Spring Assist	60"	NA	A, B & C	Open Roll & 4" Fascia
PowerWand	Powerwand 1.0 Li-Ion	21"	43"	A	All
	Powerwand 2.0 Li-Ion	22"	45"	A & B	(except 3" Fascia)
Lithium-ion Motors	Bliss™ 1.1 Li-Ion	21 1/2"	44"	A	All
	Bliss™ 2.0 Li-Ion	29"	59"	A & B	
	Sonesse® 28 WireFree™ RTS Li-Ion / Sonesse® 28 WireFree™ Zigbee Li-Ion	24 1/2"	50"	A	
	Sonesse® ULTRA 30 WireFree™ RTS Li-Ion	28 1/2"	58"	A & B	
DC Motors	Bliss™ 1.1 DC	16 1/2"	34"	A	All
	Bliss™ 2.0 DC	22 1/2"	46"	A & B	
	Sonesse® 28 WireFree™ RTS DC / Sonesse® 28 WireFree™ Zigbee DC	16 1/2"	34"	A	
	Sonesse® 30 RTS 24v DC	21"	NA	A & B	

**See Spring Assist Section in reference guide for details

*Not all fabrics are available in all zones

Control System and Top Treatment Compatibility Chart - High Torque Motors

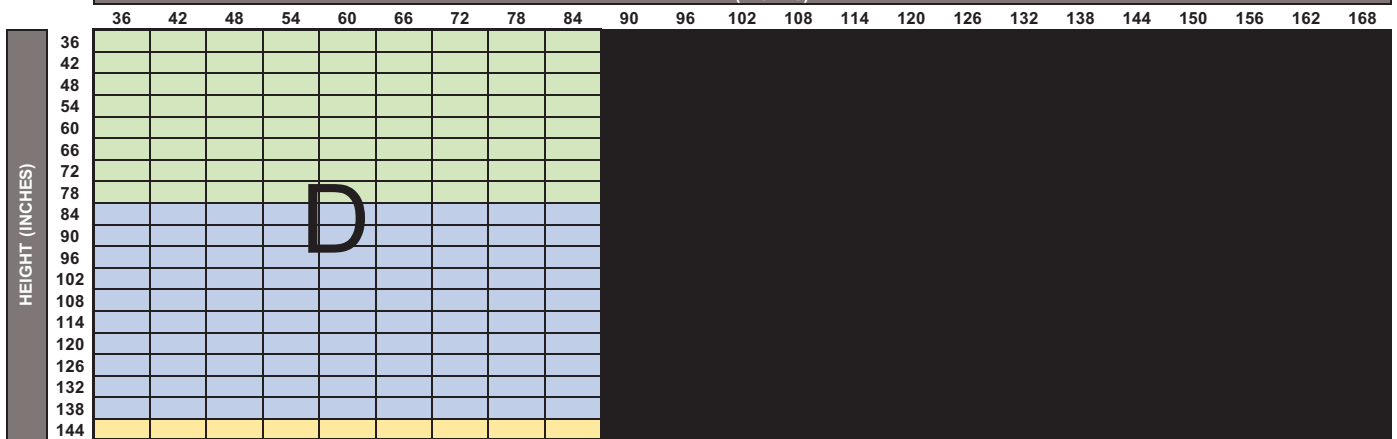

Control Systems (Minimum height for all Control Systems is 12")		Minimum Width (Single Panel)	Overall Minimum Width (2-on-1)	Specification Zone(s)*	Top Treatment
Lithium-ion Motors	Bliss™ 3.0 Li-Ion	32"	65"	D & E	All
	Sonesse® 40 WireFree™ RTS Li-Ion	31"	63"	D	
AC Motors	Bliss™ 10.0 AC	35"	NA	D & E	Open Roll, Fabric Cornice, and 4" Fascia
	Sonesse® 50 RTS AC (120V)	33"	NA	D & E	
	Sonesse® Ultra 50 AC (120V)	39"	NA	D & E	

*Not all fabrics are available in all zones

PRODUCT SIZE SPECIFICATIONS – CONTINUOUS LOOP CONTROL & AUTOMATION

Collection Code	Collection Name	Max Width Non-Railroaded ** (inches)	Max Width Railroaded (inches)	Available with Seam
AF030	Alpine	118	168	Yes

**To determine the maximum width for continuous Fabric Cornices, subtract 4 inches from the maximum non-railroad width.

- Railroad Fabrics (turned width for length) will have a visible seam when fabricated longer than the maximum roll width less 16".
- Red Box in spec chart indicates shade sizes Heat Sealed Hem Bar is recommended. For Continuous Loop Control, metal chain is also recommended for these sizes.

Top Treatment	Legend			
Medium Cassette				
3" Fascia				
Large Cassette				
Square Cassette				
Fabric Cornice				
4" Fascia				
Open Roll				

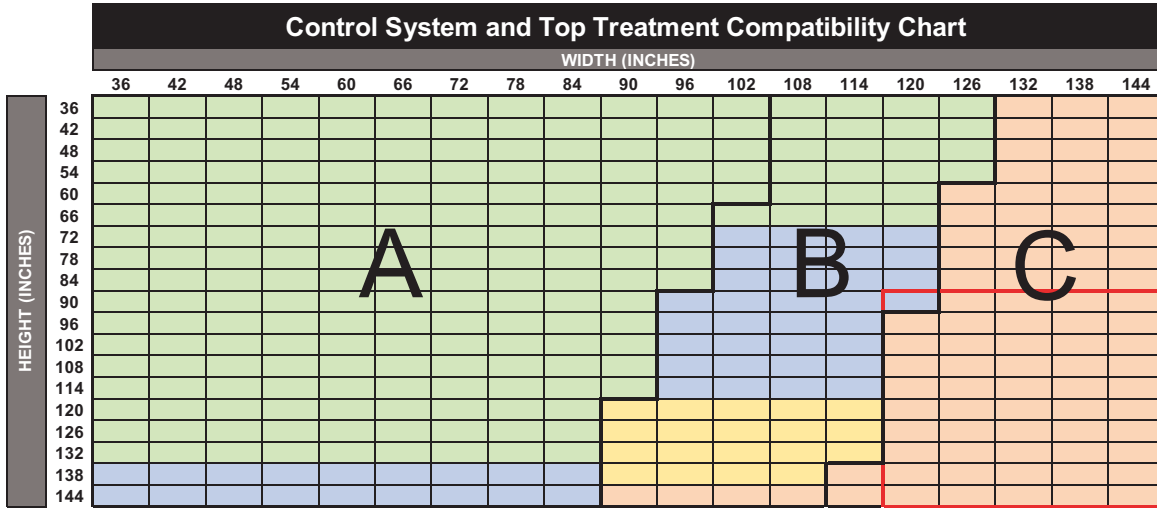

Control Systems (Minimum height for all Control Systems is 12")		Minimum Width (Single Panel)	Overall Minimum Width (2-on-1)	Specification Zone(s)*	Top Treatment
Continuous Loop Control	Continuous Loop Control (Maximum height for 12" width is 60")	12"	24"	A, B & C	All
	**Continuous Loop Control with Spring Assist	60"	NA	A, B & C	Open Roll & 4" Fascia
PowerWand	Powerwand 1.0 Li-Ion	21"	43"	A	All
	Powerwand 2.0 Li-Ion	22"	45"	A & B	(except 3" Fascia)
Lithium-ion Motors	Bliss™ 1.1 Li-Ion	21 1/2"	44"	A	All
	Bliss™ 2.0 Li-Ion	29"	59"	A & B	
	Sonessé® 28 WireFree™ RTS Li-Ion / Sonessé® 28 WireFree™ Zigbee Li-Ion	24 1/2"	50"	A	
	Sonessé® ULTRA 30 WireFree™ RTS Li-Ion	28 1/2"	58"	A & B	
DC Motors	Bliss™ 1.1 DC	16 1/2"	34"	A	All
	Bliss™ 2.0 DC	22 1/2"	46"	A & B	
	Sonessé® 28 WireFree™ RTS DC / Sonessé® 28 WireFree™ Zigbee DC	16 1/2"	34"	A	
	Sonessé® 30 RTS 24v DC	21"	NA	A & B	

**See Spring Assist Section in reference guide for details

*Not all fabrics are available in all zones

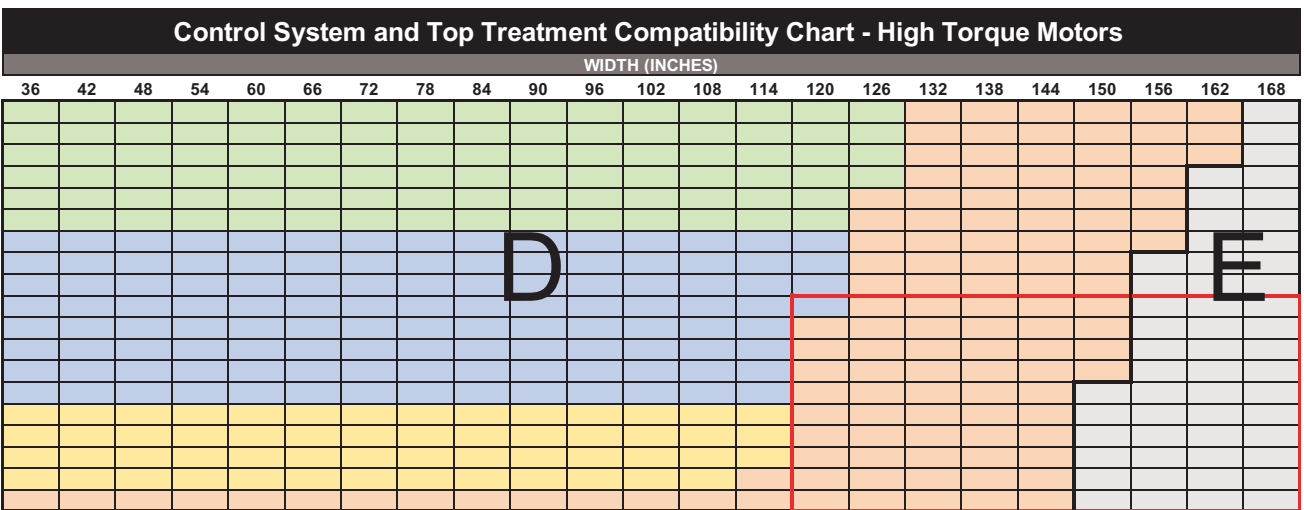

Control Systems (Minimum height for all Control Systems is 12")		Minimum Width (Single Panel)	Overall Minimum Width (2-on-1)	Specification Zone(s)*	Top Treatment
Lithium-ion Motors	Bliss™ 3.0 Li-Ion	32"	65"	D & E	All
	Sonessé® 40 WireFree™ RTS Li-Ion	31"	63"	D	
AC Motors	Bliss™ 10.0 AC	35"	NA	D & E	Open Roll, Fabric Cornice, and 4" Fascia
	Sonessé® 50 RTS AC (120V)	33"	NA	D & E	
	Sonessé® Ultra 50 AC (120V)	39"	NA	D & E	

*Not all fabrics are available in all zones

PRODUCT SIZE SPECIFICATIONS – CONTINUOUS LOOP CONTROL & AUTOMATION

Collection Code	Collection Name	Max Width Non-Railroaded ** (inches)	Max Width Railroaded (inches)	Available with Seam
AB030	Alpine Blackout	118	168	Yes

**To determine the maximum width for continuous Fabric Cornices, subtract 4 inches from the maximum non-railroad width.

- Railroad Fabrics (turned width for length) will have a visible seam when fabricated longer than the maximum roll width less 16".
- Red Box in spec chart indicates shade sizes Heat Sealed Hem Bar is recommended. For Continuous Loop Control, metal chain is also recommended for these sizes.

Top Treatment	Legend			
Medium Cassette				
3" Fascia				
Large Cassette				
Square Cassette				
Fabric Cornice				
4" Fascia				
Open Roll				

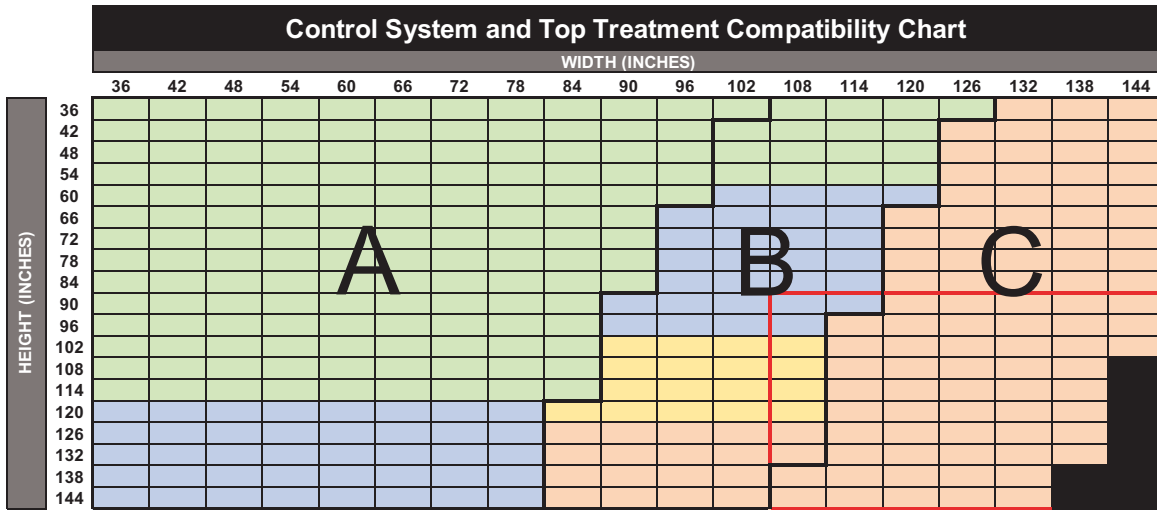

Control Systems (Minimum height for all Control Systems is 12")		Minimum Width (Single Panel)	Overall Minimum Width (2-on-1)	Specification Zone(s)*	Top Treatment
Continuous Loop Control	Continuous Loop Control (Maximum height for 12" width is 60")	12"	24"	A, B & C	All
	**Continuous Loop Control with Spring Assist	60"	NA	A, B & C	Open Roll & 4" Fascia
PowerWand	Powerwand 1.0 Li-Ion	21"	43"	A	All
	Powerwand 2.0 Li-Ion	22"	45"	A & B	(except 3" Fascia)
Lithium-ion Motors	Bliss™ 1.1 Li-Ion	21 1/2"	44"	A	All
	Bliss™ 2.0 Li-Ion	29"	59"	A & B	
	Sonessé® 28 WireFree™ RTS Li-Ion / Sonessé® 28 WireFree™ Zigbee Li-Ion	24 1/2"	50"	A	
	Sonessé® ULTRA 30 WireFree™ RTS Li-Ion	28 1/2"	58"	A & B	
DC Motors	Bliss™ 1.1 DC	16 1/2"	34"	A	All
	Bliss™ 2.0 DC	22 1/2"	46"	A & B	
	Sonessé® 28 WireFree™ RTS DC / Sonessé® 28 WireFree™ Zigbee DC	16 1/2"	34"	A	
	Sonessé® 30 RTS 24v DC	21"	NA	A & B	

**See Spring Assist Section in reference guide for details

*Not all fabrics are available in all zones

Control System and Top Treatment Compatibility Chart - High Torque Motors

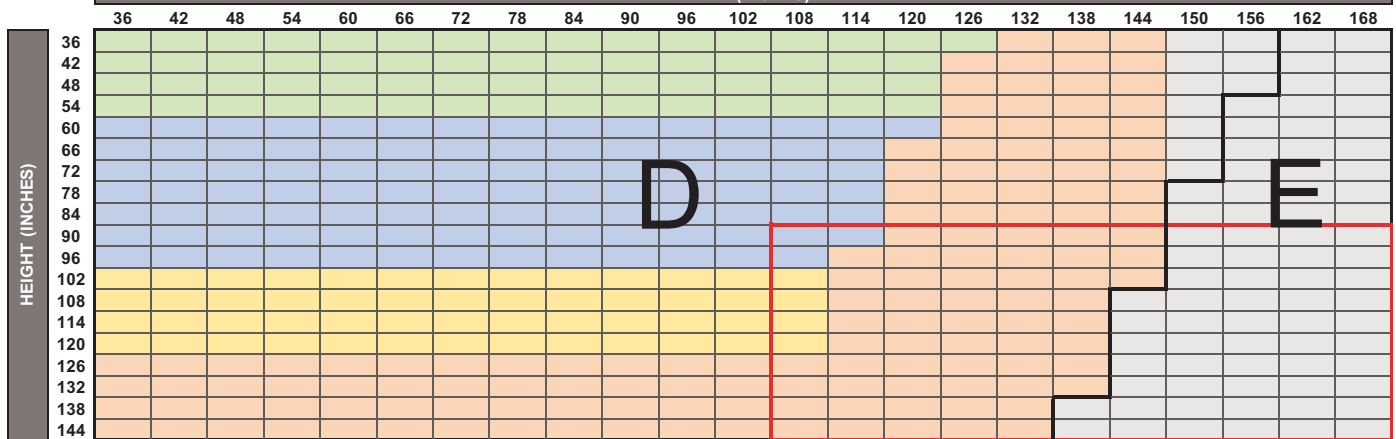

Control Systems (Minimum height for all Control Systems is 12")		Minimum Width (Single Panel)	Overall Minimum Width (2-on-1)	Specification Zone(s)*	Top Treatment
Lithium-ion Motors	Bliss™ 3.0 Li-Ion	32"	65"	D & E	All
	Sonessé® 40 WireFree™ RTS Li-Ion	31"	63"	D	
AC Motors	Bliss™ 10.0 AC	35"	NA	D & E	Open Roll, Fabric Cornice, and 4" Fascia
	Sonessé® 50 RTS AC (120V)	33"	NA	D & E	
	Sonessé® Ultra 50 AC (120V)	39"	NA	D & E	

*Not all fabrics are available in all zones

PRODUCT SIZE SPECIFICATIONS – CONTINUOUS LOOP CONTROL & AUTOMATION

Collection Code	Collection Name	Max Width Non-Railroaded ** (inches)	Max Width Railroaded (inches)	Available with Seam
AF020	Aqua-Tex	118	NA	No

**To determine the maximum width for continuous Fabric Cornices, subtract 4 inches from the maximum non-railroad width.

- Railroad Fabrics (turned width for length) will have a visible seam when fabricated longer than the maximum roll width less 16".
- Red Box in spec chart indicates shade sizes Heat Sealed Hem Bar is recommended. For Continuous Loop Control, metal chain is also recommended for these sizes.

Top Treatment	Legend			
Medium Cassette				
3" Fascia				
Large Cassette				
Square Cassette				
Fabric Cornice				
4" Fascia				
Open Roll				

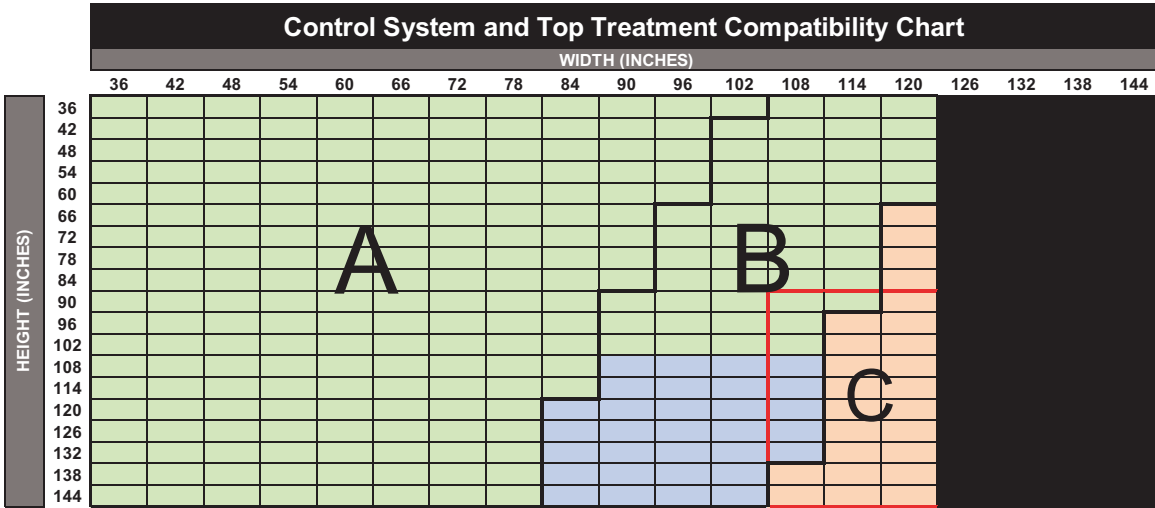

Control Systems (Minimum height for all Control Systems is 12")		Minimum Width (Single Panel)	Overall Minimum Width (2-on-1)	Specification Zone(s)*	Top Treatment
Continuous Loop Control	Continuous Loop Control (Maximum height for 12" width is 60")	12"	24"	A, B & C	All
	**Continuous Loop Control with Spring Assist	60"	NA	A, B & C	Open Roll & 4" Fascia
PowerWand	Powerwand 1.0 Li-Ion	21"	43"	A	All
	Powerwand 2.0 Li-Ion	22"	45"	A & B	(except 3" Fascia)
Lithium-ion Motors	Bliss™ 1.1 Li-Ion	21 1/2"	44"	A	All
	Bliss™ 2.0 Li-Ion	29"	59"	A & B	
	Sonessé® 28 WireFree™ RTS Li-Ion / Sonessé® 28 WireFree™ Zigbee Li-Ion	24 1/2"	50"	A	
	Sonessé® ULTRA 30 WireFree™ RTS Li-Ion	28 1/2"	58"	A & B	
DC Motors	Bliss™ 1.1 DC	16 1/2"	34"	A	All
	Bliss™ 2.0 DC	22 1/2"	46"	A & B	
	Sonessé® 28 WireFree™ RTS DC / Sonessé® 28 WireFree™ Zigbee DC	16 1/2"	34"	A	
	Sonessé® 30 RTS 24v DC	21"	NA	A & B	

**See Spring Assist Section in reference guide for details

*Not all fabrics are available in all zones

Control System and Top Treatment Compatibility Chart - High Torque Motors

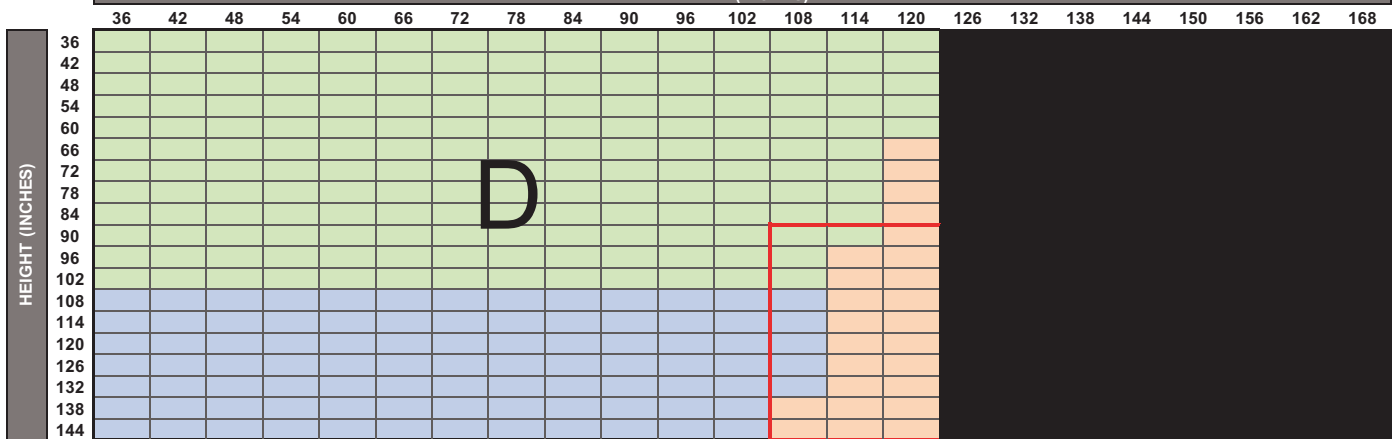

Control Systems (Minimum height for all Control Systems is 12")		Minimum Width (Single Panel)	Overall Minimum Width (2-on-1)	Specification Zone(s)*	Top Treatment
Lithium-ion Motors	Bliss™ 3.0 Li-Ion	32"	65"	D & E	All
	Sonessé® 40 WireFree™ RTS Li-Ion	31"	63"	D	
AC Motors	Bliss™ 10.0 AC	35"	NA	D & E	Open Roll, Fabric Cornice, and 4" Fascia
	Sonessé® 50 RTS AC (120V)	33"	NA	D & E	
	Sonessé® Ultra 50 AC (120V)	39"	NA	D & E	

*Not all fabrics are available in all zones

PRODUCT SIZE SPECIFICATIONS – CONTINUOUS LOOP CONTROL & AUTOMATION

Collection Code	Collection Name	Max Width Non-Railroaded ** (inches)	Max Width Railroaded (inches)	Available with Seam
AB020	Aqua-Tex Blackout	114	NA	No

**To determine the maximum width for continuous Fabric Cornices, subtract 4 inches from the maximum non-railroad width.

· Railroad Fabrics (turned width for length) will have a visible seam when fabricated longer than the maximum roll width less 16".
 · Red Box in spec chart indicates shade sizes Heat Sealed Hem Bar is recommended. For Continuous Loop Control, metal chain is also recommended for these sizes.

Top Treatment	Legend			
Medium Cassette				
3" Fascia				
Large Cassette				
Square Cassette				
Fabric Cornice				
4" Fascia				
Open Roll				

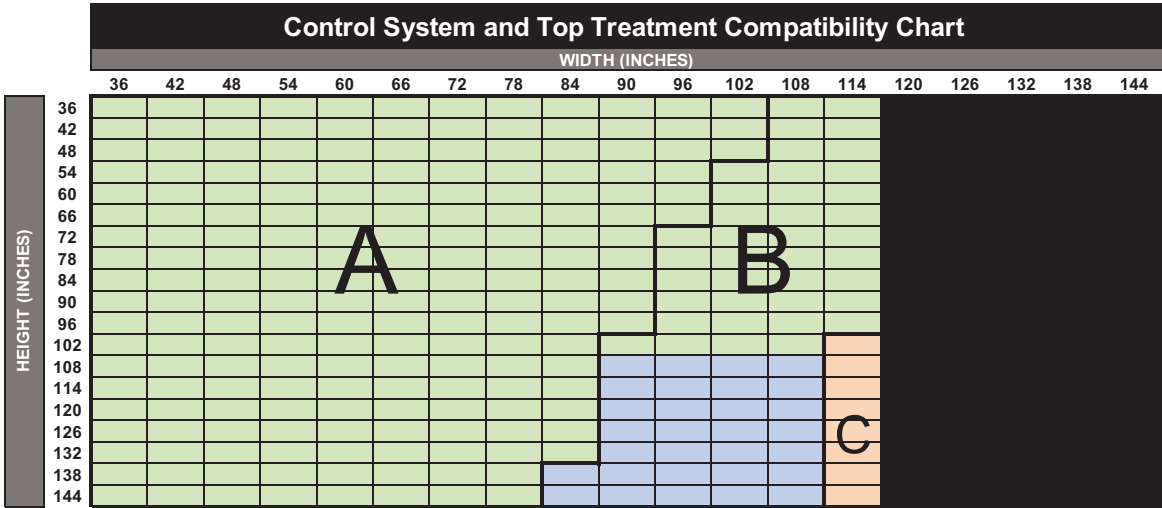

Control Systems (Minimum height for all Control Systems is 12")		Minimum Width (Single Panel)	Overall Minimum Width (2-on-1)	Specification Zone(s)*	Top Treatment
Continuous Loop Control	Continuous Loop Control (Maximum height for 12" width is 60")	12"	24"	A, B & C	All
	**Continuous Loop Control with Spring Assist	60"	NA	A, B & C	Open Roll & 4" Fascia
PowerWand	Powerwand 1.0 Li-Ion	21"	43"	A	All
	Powerwand 2.0 Li-Ion	22"	45"	A & B	(except 3" Fascia)
Lithium-ion Motors	Bliss™ 1.1 Li-Ion	21 1/2"	44"	A	All
	Bliss™ 2.0 Li-Ion	29"	59"	A & B	
	Sonessé® 28 WireFree™ RTS Li-Ion / Sonessé® 28 WireFree™ Zigbee Li-Ion	24 1/2"	50"	A	
	Sonessé® ULTRA 30 WireFree™ RTS Li-Ion	28 1/2"	58"	A & B	
DC Motors	Bliss™ 1.1 DC	16 1/2"	34"	A	All
	Bliss™ 2.0 DC	22 1/2"	46"	A & B	
	Sonessé® 28 WireFree™ RTS DC / Sonessé® 28 WireFree™ Zigbee DC	16 1/2"	34"	A	
	Sonessé® 30 RTS 24v DC	21"	NA	A & B	

**See Spring Assist Section in reference guide for details

*Not all fabrics are available in all zones

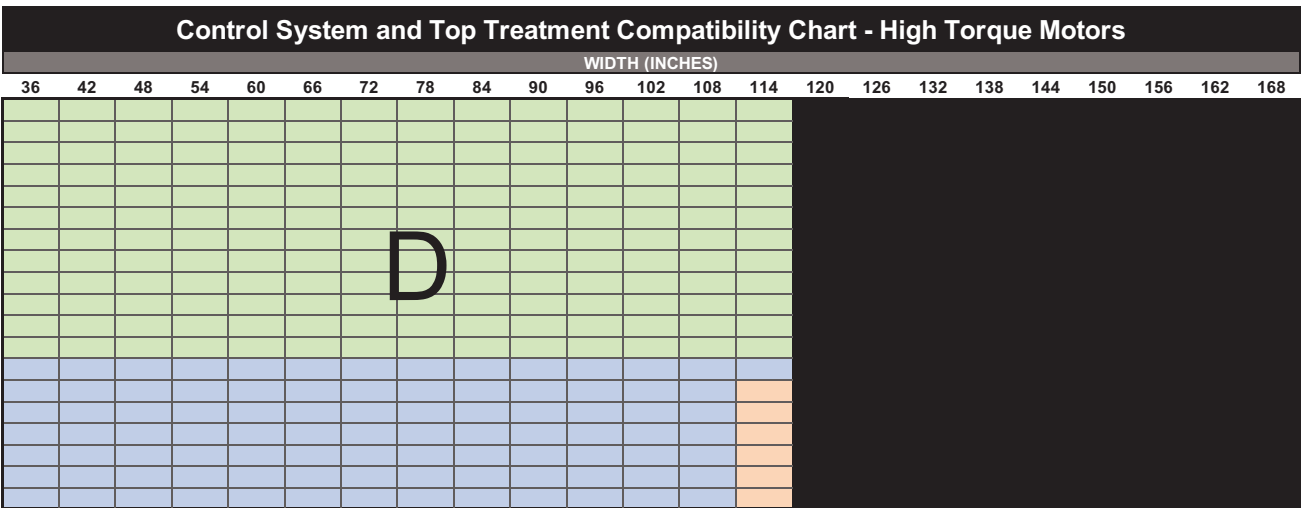

Control Systems (Minimum height for all Control Systems is 12")		Minimum Width (Single Panel)	Overall Minimum Width (2-on-1)	Specification Zone(s)*	Top Treatment
Lithium-ion Motors	Bliss™ 3.0 Li-Ion	32"	65"	D & E	All
	Sonessé® 40 WireFree™ RTS Li-Ion	31"	63"	D	
AC Motors	Bliss™ 10.0 AC	35"	NA	D & E	Open Roll, Fabric Cornice, and 4" Fascia
	Sonessé® 50 RTS AC (120V)	33"	NA	D & E	
	Sonessé® Ultra 50 AC (120V)	39"	NA	D & E	

*Not all fabrics are available in all zones

PRODUCT SIZE SPECIFICATIONS – CONTINUOUS LOOP CONTROL & AUTOMATION

Collection Code	Collection Name	Max Width Non-Railroaded ** (inches)	Max Width Railroaded (inches)	Available with Seam
AF035	Arches	118	NA	No
AF024	Bellflower	113	NA	No

**To determine the maximum width for continuous Fabric Cornices, subtract 4 inches from the maximum non-railroad width.

• Railroad Fabrics (turned width for length) will have a visible seam when fabricated longer than the maximum roll width less 16".

• Red Box in spec chart indicates shade sizes Heat Sealed Hem Bar is recommended. For Continuous Loop Control, metal chain is also recommended for these sizes.

Top Treatment	Legend			
Medium Cassette	Green	Blue	Yellow	Orange
3" Fascia	Green	Blue	Yellow	Orange
Large Cassette	Green	Blue	Yellow	Orange
Square Cassette	Green	Blue	Yellow	Orange
Fabric Cornice	Green	Blue	Yellow	Orange
4" Fascia	Green	Blue	Yellow	Orange
Open Roll	Green	Blue	Yellow	Orange

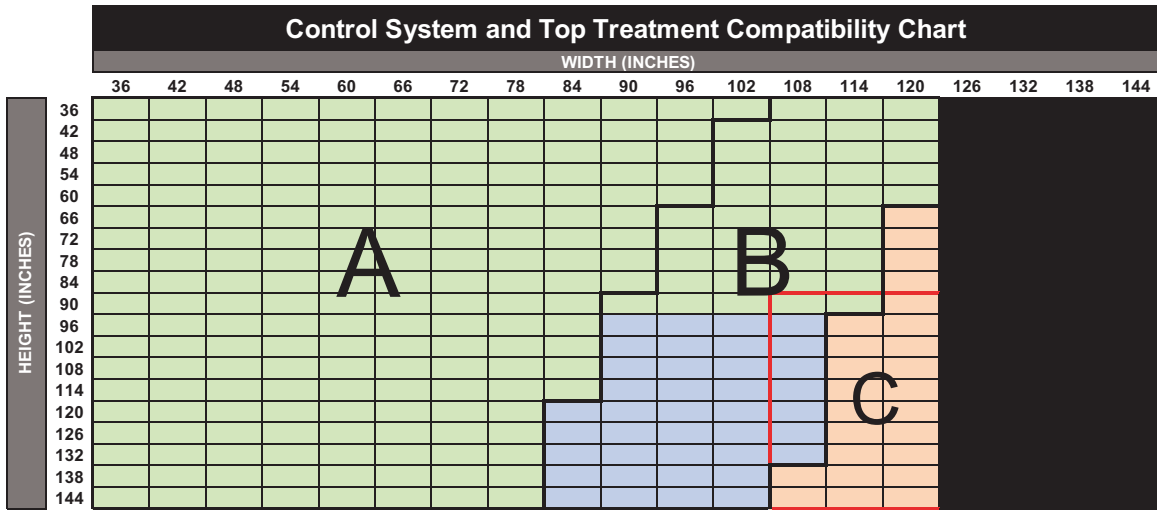

Control Systems (Minimum height for all Control Systems is 12")		Minimum Width (Single Panel)	Overall Minimum Width (2-on-1)	Specification Zone(s)*	Top Treatment
Continuous Loop Control	Continuous Loop Control (Maximum height for 12" width is 60")	12"	24"	A, B & C	All
	**Continuous Loop Control with Spring Assist	60"	NA	A, B & C	Open Roll & 4" Fascia
PowerWand	Powerwand 1.0 Li-Ion	21"	43"	A	All
	Powerwand 2.0 Li-Ion	22"	45"	A & B	(except 3" Fascia)
Lithium-ion Motors	Bliss™ 1.1 Li-Ion	21 1/2"	44"	A	All
	Bliss™ 2.0 Li-Ion	29"	59"	A & B	
	Sonessé® 28 WireFree™ RTS Li-Ion / Sonessé® 28 WireFree™ Zigbee Li-Ion	24 1/2"	50"	A	
	Sonessé® ULTRA 30 WireFree™ RTS Li-Ion	28 1/2"	58"	A & B	
DC Motors	Bliss™ 1.1 DC	16 1/2"	34"	A	All
	Bliss™ 2.0 DC	22 1/2"	46"	A & B	
	Sonessé® 28 WireFree™ RTS DC / Sonessé® 28 WireFree™ Zigbee DC	16 1/2"	34"	A	
	Sonessé® 30 RTS 24v DC	21"	NA	A & B	

**See Spring Assist Section in reference guide for details

*Not all fabrics are available in all zones

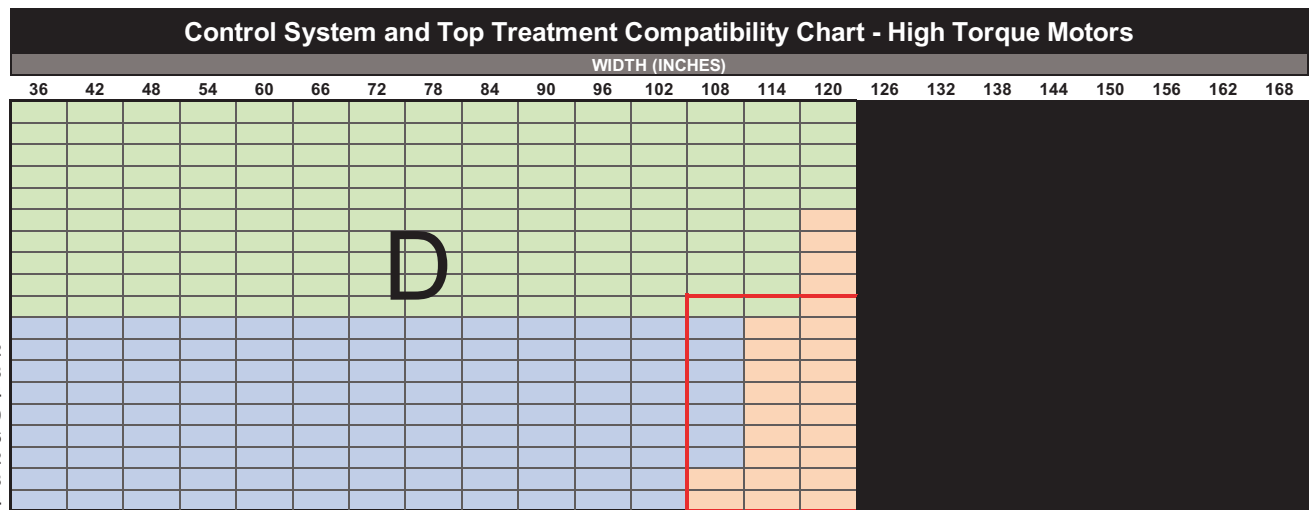

Control Systems (Minimum height for all Control Systems is 12")		Minimum Width (Single Panel)	Overall Minimum Width (2-on-1)	Specification Zone(s)*	Top Treatment
Lithium-ion Motors	Bliss™ 3.0 Li-Ion	32"	65"	D & E	All
	Sonessé® 40 WireFree™ RTS Li-Ion	31"	63"	D	
AC Motors	Bliss™ 10.0 AC	35"	NA	D & E	Open Roll, Fabric Cornice, and 4" Fascia
	Sonessé® 50 RTS AC (120V)	33"	NA	D & E	
	Sonessé® Ultra 50 AC (120V)	39"	NA	D & E	

*Not all fabrics are available in all zones

PRODUCT SIZE SPECIFICATIONS – CONTINUOUS LOOP CONTROL & AUTOMATION

Collection Code	Collection Name	Max Width Non-Railroaded ** (inches)	Max Width Railroaded (inches)	Available with Seam
AB035	Arches Blackout	118	NA	No
AB024	Bellflower Blackout	113	NA	No

**To determine the maximum width for continuous Fabric Cornices, subtract 4 inches from the maximum non-railroad width.

· Railroad Fabrics (turned width for length) will have a visible seam when fabricated longer than the maximum roll width less 16".

· Red Box in spec chart indicates shade sizes Heat Sealed Hem Bar is recommended. For Continuous Loop Control, metal chain is also recommended for these sizes.

Top Treatment	Legend			
Medium Cassette				
3" Fascia				
Large Cassette				
Square Cassette				
Fabric Cornice				
4" Fascia				
Open Roll				

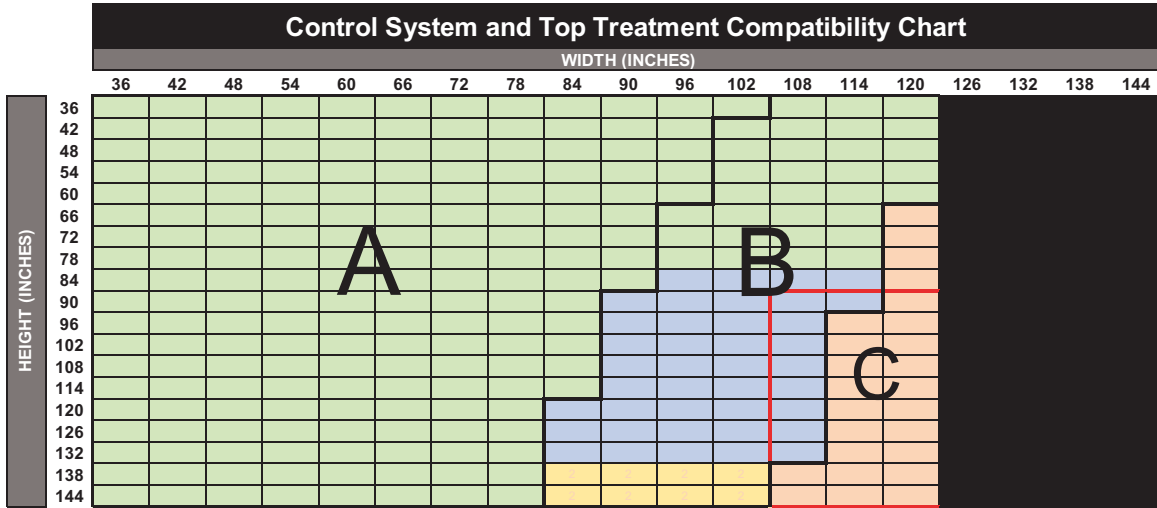

Control Systems (Minimum height for all Control Systems is 12")		Minimum Width (Single Panel)	Overall Minimum Width (2-on-1)	Specification Zone(s)*	Top Treatment
Continuous Loop Control	Continuous Loop Control (Maximum height for 12" width is 60")	12"	24"	A, B & C	All
	**Continuous Loop Control with Spring Assist	60"	NA	A, B & C	Open Roll & 4" Fascia
PowerWand	Powerwand 1.0 Li-Ion	21"	43"	A	All
	Powerwand 2.0 Li-Ion	22"	45"	A & B	(except 3" Fascia)
Lithium-ion Motors	Bliss™ 1.1 Li-Ion	21 1/2"	44"	A	All
	Bliss™ 2.0 Li-Ion	29"	59"	A & B	
	Sonessé® 28 WireFree™ RTS Li-Ion / Sonessé® 28 WireFree™ Zigbee Li-Ion	24 1/2"	50"	A	
	Sonessé® ULTRA 30 WireFree™ RTS Li-Ion	28 1/2"	58"	A & B	
DC Motors	Bliss™ 1.1 DC	16 1/2"	34"	A	All
	Bliss™ 2.0 DC	22 1/2"	46"	A & B	
	Sonessé® 28 WireFree™ RTS DC / Sonessé® 28 WireFree™ Zigbee DC	16 1/2"	34"	A	
	Sonessé® 30 RTS 24v DC	21"	NA	A & B	

**See Spring Assist Section in reference guide for details

*Not all fabrics are available in all zones

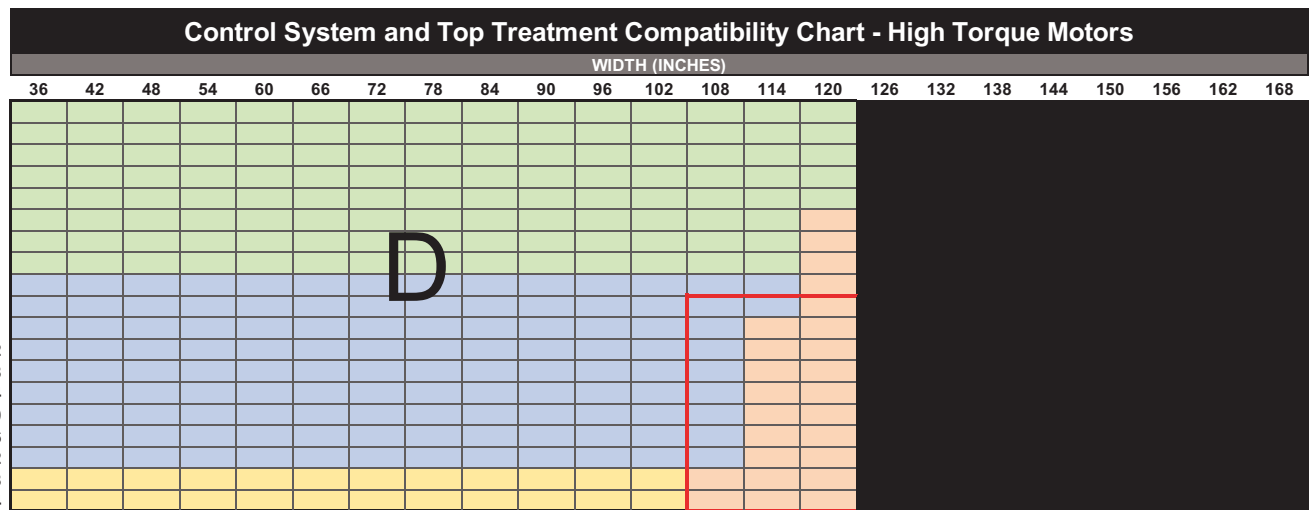

Control Systems (Minimum height for all Control Systems is 12")		Minimum Width (Single Panel)	Overall Minimum Width (2-on-1)	Specification Zone(s)*	Top Treatment
Lithium-ion Motors	Bliss™ 3.0 Li-Ion	32"	65"	D & E	All
	Sonessé® 40 WireFree™ RTS Li-Ion	31"	63"	D	
AC Motors	Bliss™ 10.0 AC	35"	NA	D & E	Open Roll, Fabric Cornice, and 4" Fascia
	Sonessé® 50 RTS AC (120V)	33"	NA	D & E	
	Sonessé® Ultra 50 AC (120V)	39"	NA	D & E	

*Not all fabrics are available in all zones

PRODUCT SIZE SPECIFICATIONS – CONTINUOUS LOOP CONTROL & AUTOMATION

Collection Code	Collection Name	Max Width Non-Railroaded ** (inches)	Max Width Railroaded (inches)	Available with Seam
AB022	Aries Blackout	118	NA	No

**To determine the maximum width for continuous Fabric Cornices, subtract 4 inches from the maximum non-railroad width.

- Railroad Fabrics (turned width for length) will have a visible seam when fabricated longer than the maximum roll width less 16".
- Red Box in spec chart indicates shade sizes Heat Sealed Hem Bar is recommended. For Continuous Loop Control, metal chain is also recommended for these sizes.

Top Treatment	Legend			
Medium Cassette				
3" Fascia				
Large Cassette				
Square Cassette				
Fabric Cornice				
4" Fascia				
Open Roll				

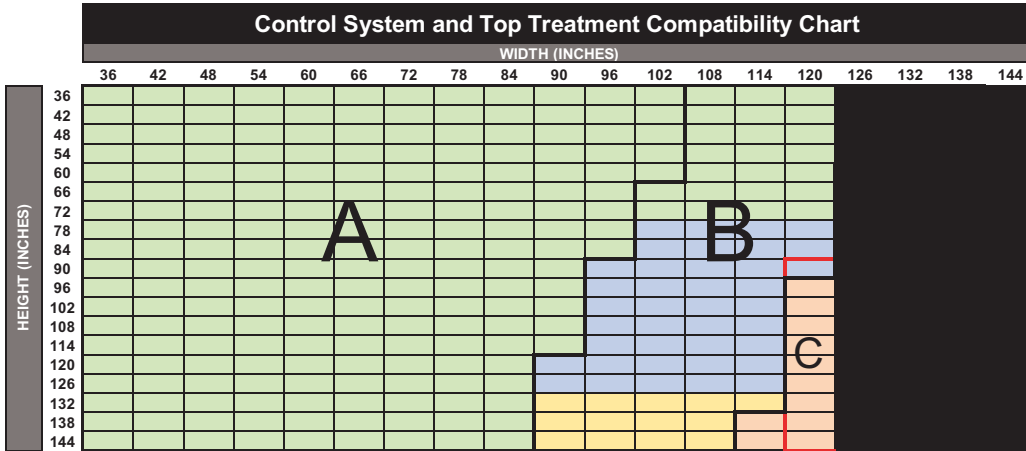

Control Systems (Minimum height for all Control Systems is 12")		Minimum Width (Single Panel)	Overall Minimum Width (2-on-1)	Specification Zone(s)*	Top Treatment
Continuous Loop Control	Continuous Loop Control (Maximum height for 12" width is 60")	12"	24"	A, B & C	All
	**Continuous Loop Control with Spring Assist	60"	NA	A, B & C	Open Roll & 4" Fascia
PowerWand	Powerwand 1.0 Li-Ion	21"	43"	A	All
	Powerwand 2.0 Li-Ion	22"	45"	A & B	(except 3" Fascia)
Lithium-ion Motors	Bliss™ 1.1 Li-Ion	21 1/2"	44"	A	All
	Bliss™ 2.0 Li-Ion	29"	59"	A & B	
	Sonessé® 28 WireFree™ RTS Li-Ion / Sonessé® 28 WireFree™ Zigbee Li-Ion	24 1/2"	50"	A	
	Sonessé® ULTRA 30 WireFree™ RTS Li-Ion	28 1/2"	58"	A & B	
DC Motors	Bliss™ 1.1 DC	16 1/2"	34"	A	All
	Bliss™ 2.0 DC	22 1/2"	46"	A & B	
	Sonessé® 28 WireFree™ RTS DC / Sonessé® 28 WireFree™ Zigbee DC	16 1/2"	34"	A	
	Sonessé® 30 RTS 24v DC	21"	NA	A & B	

**See Spring Assist Section in reference guide for details

*Not all fabrics are available in all zones

Control System and Top Treatment Compatibility Chart - High Torque Motors

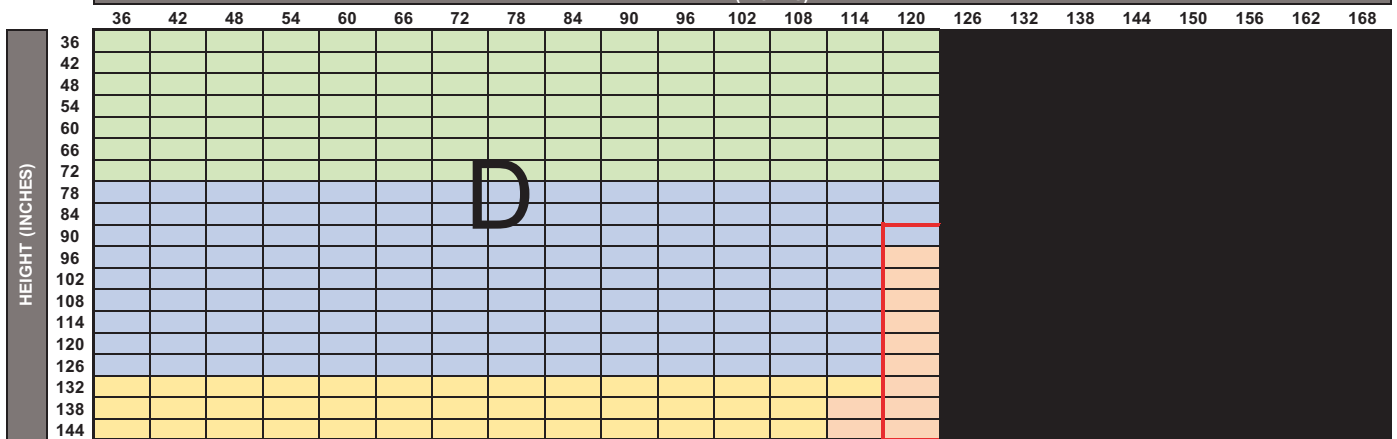

Control Systems (Minimum height for all Control Systems is 12")		Minimum Width (Single Panel)	Overall Minimum Width (2-on-1)	Specification Zone(s)*	Top Treatment
Lithium-ion Motors	Bliss™ 3.0 Li-Ion	32"	65"	D & E	All
	Sonessé® 40 WireFree™ RTS Li-Ion	31"	63"	D	
AC Motors	Bliss™ 10.0 AC	35"	NA	D & E	Open Roll, Fabric Cornice, and 4" Fascia
	Sonessé® 50 RTS AC (120V)	33"	NA	D & E	
	Sonessé® Ultra 50 AC (120V)	39"	NA	D & E	

*Not all fabrics are available in all zones

PRODUCT SIZE SPECIFICATIONS – CONTINUOUS LOOP CONTROL & AUTOMATION

Collection Code	Collection Name	Max Width Non-Railroaded ** (inches)	Max Width Railroaded (inches)	Available with Seam
AF019	Baltic	110	NA	No

**To determine the maximum width for continuous Fabric Cornices, subtract 4 inches from the maximum non-railroad width.

- Railroad Fabrics (turned width for length) will have a visible seam when fabricated longer than the maximum roll width less 16".
- Red Box in spec chart indicates shade sizes Heat Sealed Hem Bar is recommended. For Continuous Loop Control, metal chain is also recommended for these sizes.

Top Treatment	Legend			
Medium Cassette				
3" Fascia				
Large Cassette				
Square Cassette				
Fabric Cornice				
4" Fascia				
Open Roll				

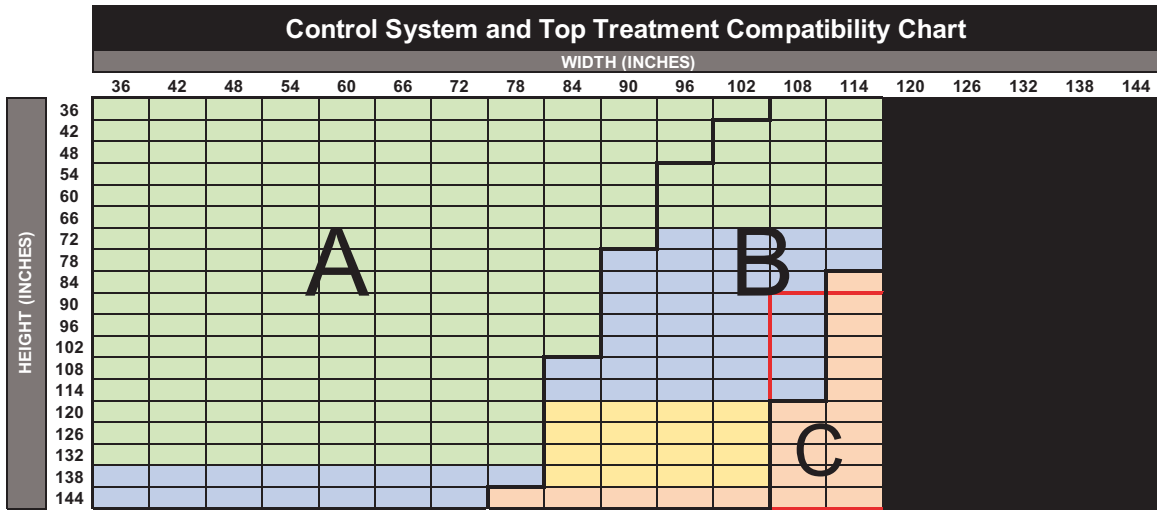

Control Systems (Minimum height for all Control Systems is 12")		Minimum Width (Single Panel)	Overall Minimum Width (2-on-1)	Specification Zone(s)*	Top Treatment
Continuous Loop Control	Continuous Loop Control (Maximum height for 12" width is 60")	12"	24"	A, B & C	All
	**Continuous Loop Control with Spring Assist	60"	NA	A, B & C	Open Roll & 4" Fascia
PowerWand	Powerwand 1.0 Li-Ion	21"	43"	A	All
	Powerwand 2.0 Li-Ion	22"	45"	A & B	(except 3" Fascia)
Lithium-ion Motors	Bliss™ 1.1 Li-Ion	21 1/2"	44"	A	All
	Bliss™ 2.0 Li-Ion	29"	59"	A & B	
	Sonessé® 28 WireFree™ RTS Li-Ion / Sonessé® 28 WireFree™ Zigbee Li-Ion	24 1/2"	50"	A	
	Sonessé® ULTRA 30 WireFree™ RTS Li-Ion	28 1/2"	58"	A & B	
DC Motors	Bliss™ 1.1 DC	16 1/2"	34"	A	All
	Bliss™ 2.0 DC	22 1/2"	46"	A & B	
	Sonessé® 28 WireFree™ RTS DC / Sonessé® 28 WireFree™ Zigbee DC	16 1/2"	34"	A	
	Sonessé® 30 RTS 24v DC	21"	NA	A & B	

**See Spring Assist Section in reference guide for details

*Not all fabrics are available in all zones

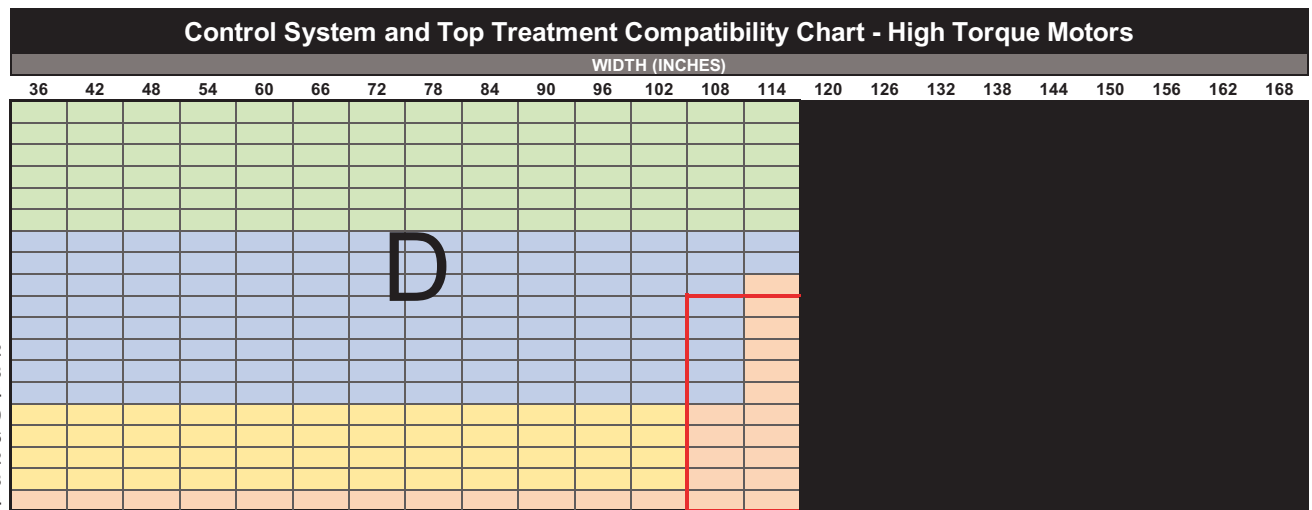

Control Systems (Minimum height for all Control Systems is 12")		Minimum Width (Single Panel)	Overall Minimum Width (2-on-1)	Specification Zone(s)*	Top Treatment
Lithium-ion Motors	Bliss™ 3.0 Li-Ion	32"	65"	D & E	All
	Sonessé® 40 WireFree™ RTS Li-Ion	31"	63"	D	
AC Motors	Bliss™ 10.0 AC	35"	NA	D & E	Open Roll, Fabric Cornice, and 4" Fascia
	Sonessé® 50 RTS AC (120V)	33"	NA	D & E	
	Sonessé® Ultra 50 AC (120V)	39"	NA	D & E	

*Not all fabrics are available in all zones

PRODUCT SIZE SPECIFICATIONS – CONTINUOUS LOOP CONTROL & AUTOMATION

Collection Code	Collection Name	Max Width Non-Railroaded ** (inches)	Max Width Railroaded (inches)	Available with Seam
AB019	Baltic Blackout	110	NA	No

**To determine the maximum width for continuous Fabric Cornices, subtract 4 inches from the maximum non-railroad width.

- Railroad Fabrics (turned width for length) will have a visible seam when fabricated longer than the maximum roll width less 16".
- Red Box in spec chart indicates shade sizes Heat Sealed Hem Bar is recommended. For Continuous Loop Control, metal chain is also recommended for these sizes.

Top Treatment	Legend			
Medium Cassette				
3" Fascia				
Large Cassette				
Square Cassette				
Fabric Cornice				
4" Fascia				
Open Roll				

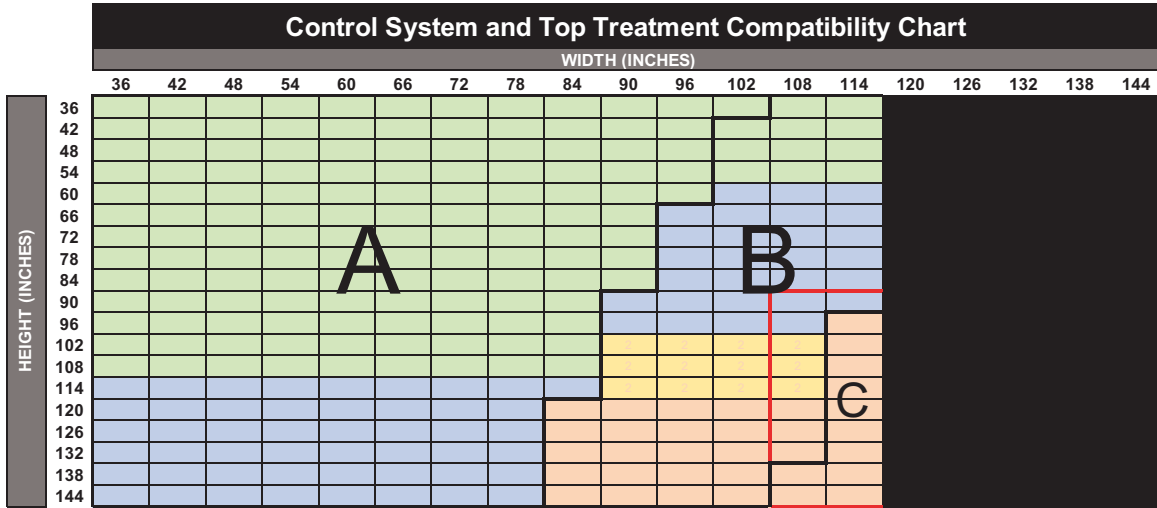

Control Systems (Minimum height for all Control Systems is 12")		Minimum Width (Single Panel)	Overall Minimum Width (2-on-1)	Specification Zone(s)*	Top Treatment
Continuous Loop Control	Continuous Loop Control (Maximum height for 12" width is 60")	12"	24"	A, B & C	All
	**Continuous Loop Control with Spring Assist	60"	NA	A, B & C	Open Roll & 4" Fascia
PowerWand	Powerwand 1.0 Li-Ion	21"	43"	A	All
	Powerwand 2.0 Li-Ion	22"	45"	A & B	(except 3" Fascia)
Lithium-ion Motors	Bliss™ 1.1 Li-Ion	21 1/2"	44"	A	All
	Bliss™ 2.0 Li-Ion	29"	59"	A & B	
	Sonessé® 28 WireFree™ RTS Li-Ion / Sonessé® 28 WireFree™ Zigbee Li-Ion	24 1/2"	50"	A	
	Sonessé® ULTRA 30 WireFree™ RTS Li-Ion	28 1/2"	58"	A & B	
DC Motors	Bliss™ 1.1 DC	16 1/2"	34"	A	All
	Bliss™ 2.0 DC	22 1/2"	46"	A & B	
	Sonessé® 28 WireFree™ RTS DC / Sonessé® 28 WireFree™ Zigbee DC	16 1/2"	34"	A	
	Sonessé® 30 RTS 24v DC	21"	NA	A & B	

**See Spring Assist Section in reference guide for details

*Not all fabrics are available in all zones

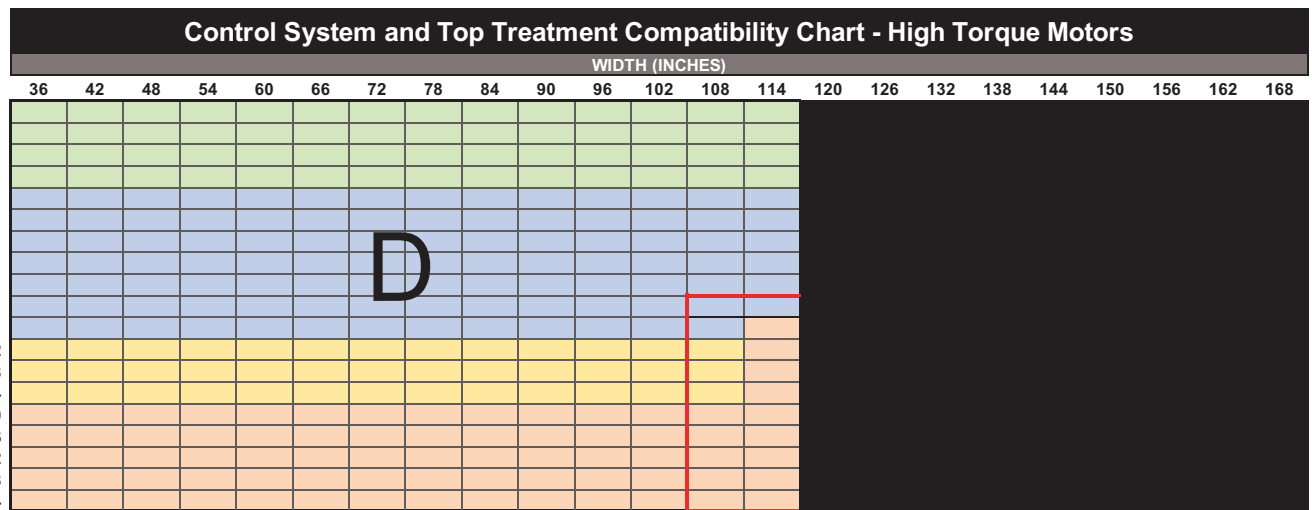

Control Systems (Minimum height for all Control Systems is 12")		Minimum Width (Single Panel)	Overall Minimum Width (2-on-1)	Specification Zone(s)*	Top Treatment
Lithium-ion Motors	Bliss™ 3.0 Li-Ion	32"	65"	D & E	All
	Sonessé® 40 WireFree™ RTS Li-Ion	31"	63"	D	
AC Motors	Bliss™ 10.0 AC	35"	NA	D & E	Open Roll, Fabric Cornice, and 4" Fascia
	Sonessé® 50 RTS AC (120V)	33"	NA	D & E	
	Sonessé® Ultra 50 AC (120V)	39"	NA	D & E	

*Not all fabrics are available in all zones

PRODUCT SIZE SPECIFICATIONS – CONTINUOUS LOOP CONTROL & AUTOMATION

Collection Code	Collection Name	Max Width Non-Railroaded ** (inches)	Max Width Railroaded (inches)	Available with Seam
R40	Blackout - Solid	72	144	Yes

**To determine the maximum width for continuous Fabric Cornices, subtract 4 inches from the maximum non-railroad width.

- Railroad Fabrics (turned width for length) will have a visible seam when fabricated longer than the maximum roll width less 16".
- Red Box in spec chart indicates shade sizes Heat Sealed Hem Bar is recommended. For Continuous Loop Control, metal chain is also recommended for these sizes.

Top Treatment	Legend			
Medium Cassette				
3" Fascia				
Large Cassette				
Square Cassette				
Fabric Cornice				
4" Fascia				
Open Roll				

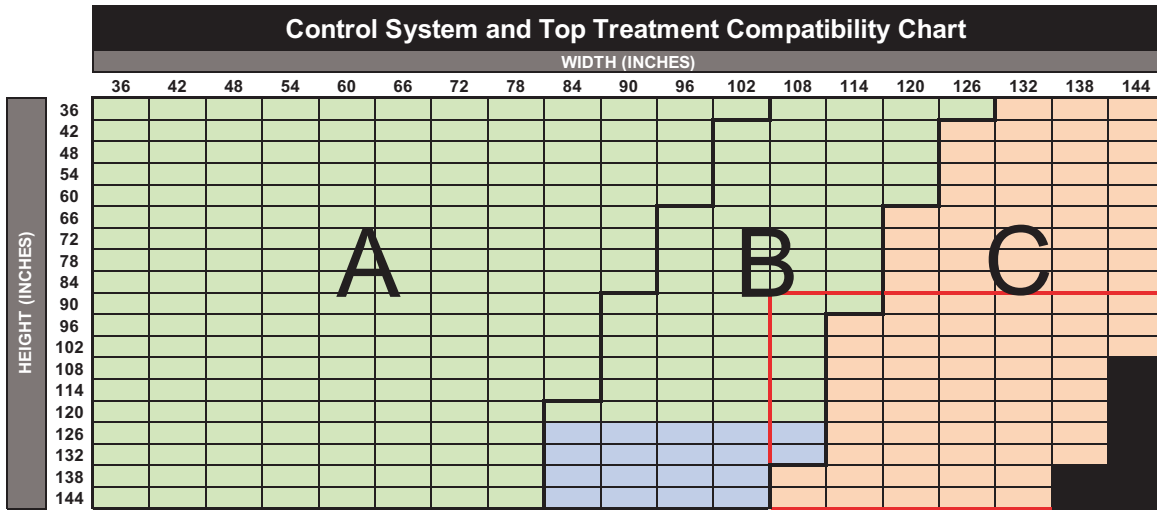

Control Systems (Minimum height for all Control Systems is 12")		Minimum Width (Single Panel)	Overall Minimum Width (2-on-1)	Specification Zone(s)*	Top Treatment
Continuous Loop Control	Continuous Loop Control (Maximum height for 12" width is 60")	12"	24"	A, B & C	All
	**Continuous Loop Control with Spring Assist	60"	NA	A, B & C	Open Roll & 4" Fascia
PowerWand	Powerwand 1.0 Li-Ion	21"	43"	A	All
	Powerwand 2.0 Li-Ion	22"	45"	A & B	(except 3" Fascia)
Lithium-ion Motors	Bliss™ 1.1 Li-Ion	21 1/2"	44"	A	All
	Bliss™ 2.0 Li-Ion	29"	59"	A & B	
	Sonessé® 28 WireFree™ RTS Li-Ion / Sonessé® 28 WireFree™ Zigbee Li-Ion	24 1/2"	50"	A	
	Sonessé® ULTRA 30 WireFree™ RTS Li-Ion	28 1/2"	58"	A & B	
DC Motors	Bliss™ 1.1 DC	16 1/2"	34"	A	All
	Bliss™ 2.0 DC	22 1/2"	46"	A & B	
	Sonessé® 28 WireFree™ RTS DC / Sonessé® 28 WireFree™ Zigbee DC	16 1/2"	34"	A	
	Sonessé® 30 RTS 24v DC	21"	NA	A & B	

**See Spring Assist Section in reference guide for details

*Not all fabrics are available in all zones

Control System and Top Treatment Compatibility Chart - High Torque Motors

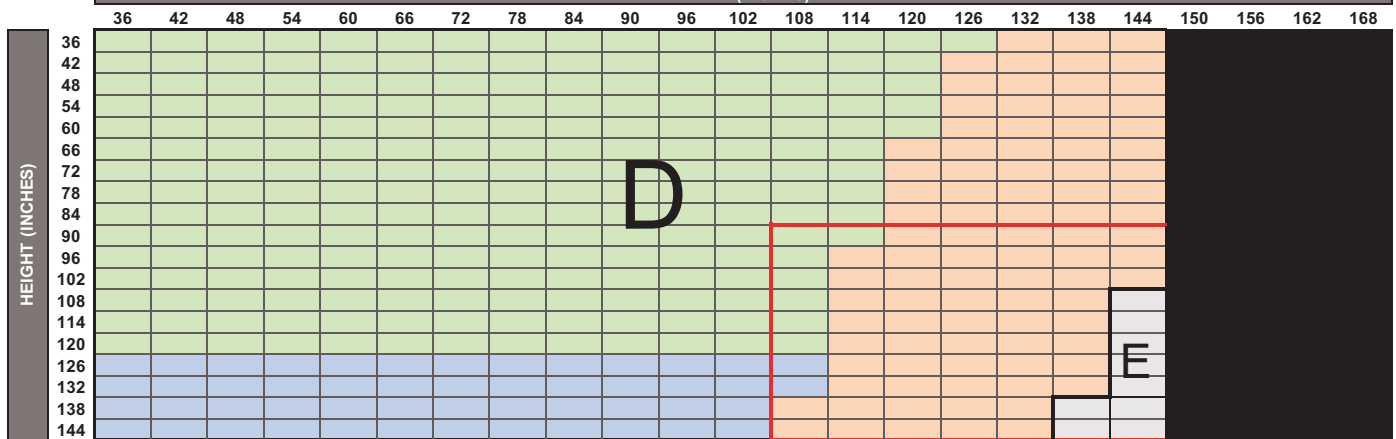

Control Systems (Minimum height for all Control Systems is 12")		Minimum Width (Single Panel)	Overall Minimum Width (2-on-1)	Specification Zone(s)*	Top Treatment
Lithium-ion Motors	Bliss™ 3.0 Li-Ion	32"	65"	D & E	All
	Sonessé® 40 WireFree™ RTS Li-Ion	31"	63"	D	
AC Motors	Bliss™ 10.0 AC	35"	NA	D & E	Open Roll, Fabric Cornice, and 4" Fascia
	Sonessé® 50 RTS AC (120V)	33"	NA	D & E	
	Sonessé® Ultra 50 AC (120V)	39"	NA	D & E	

*Not all fabrics are available in all zones

PRODUCT SIZE SPECIFICATIONS – CONTINUOUS LOOP CONTROL & AUTOMATION

Collection Code	Collection Name	Max Width Non-Railroaded ** (inches)	Max Width Railroaded (inches)	Available with Seam
AF031	Bonn	98	168	Yes

**To determine the maximum width for continuous Fabric Cornices, subtract 4 inches from the maximum non-railroad width.

- Railroad Fabrics (turned width for length) will have a visible seam when fabricated longer than the maximum roll width less 16".
- Red Box in spec chart indicates shade sizes Heat Sealed Hem Bar is recommended. For Continuous Loop Control, metal chain is also recommended for these sizes.

Top Treatment	Legend			
Medium Cassette				
3" Fascia				
Large Cassette				
Square Cassette				
Fabric Cornice				
4" Fascia				
Open Roll				

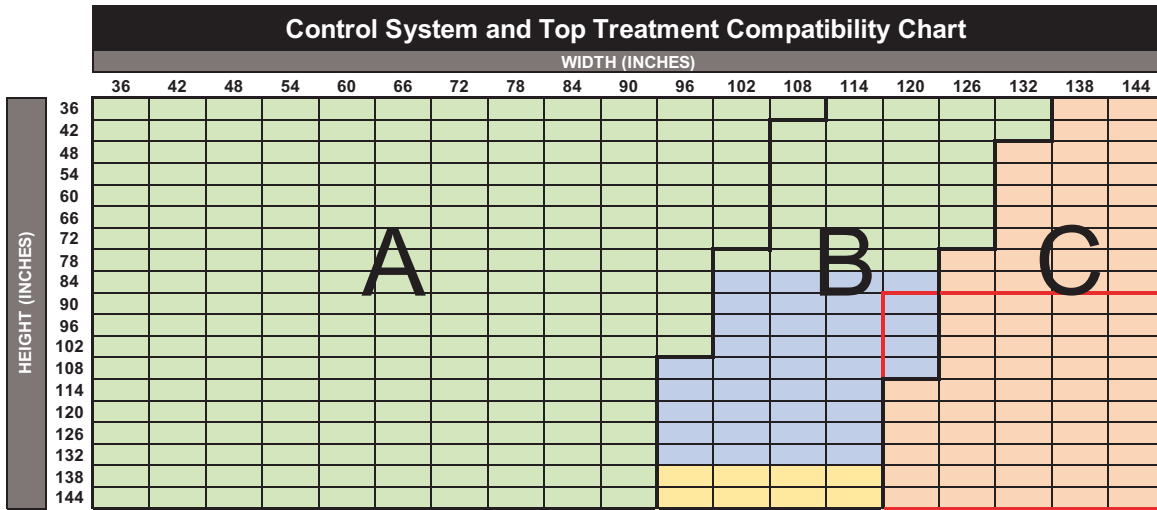

Control Systems (Minimum height for all Control Systems is 12")		Minimum Width (Single Panel)	Overall Minimum Width (2-on-1)	Specification Zone(s)*	Top Treatment
Continuous Loop Control	Continuous Loop Control (Maximum height for 12" width is 60")	12"	24"	A, B & C	All
	**Continuous Loop Control with Spring Assist	60"	NA	A, B & C	Open Roll & 4" Fascia
PowerWand	Powerwand 1.0 Li-Ion	21"	43"	A	All (except 3" Fascia)
	Powerwand 2.0 Li-Ion	22"	45"	A & B	
Lithium-ion Motors	Bliss™ 1.1 Li-Ion	21 1/2"	44"	A	All
	Bliss™ 2.0 Li-Ion	29"	59"	A & B	
	Sonessé® 28 WireFree™ RTS Li-Ion / Sonessé® 28 WireFree™ Zigbee Li-Ion	24 1/2"	50"	A	
	Sonessé® ULTRA 30 WireFree™ RTS Li-Ion	28 1/2"	58"	A & B	
DC Motors	Bliss™ 1.1 DC	16 1/2"	34"	A	All
	Bliss™ 2.0 DC	22 1/2"	46"	A & B	
	Sonessé® 28 WireFree™ RTS DC / Sonessé® 28 WireFree™ Zigbee DC	16 1/2"	34"	A	
	Sonessé® 30 RTS 24v DC	21"	NA	A & B	

**See Spring Assist Section in reference guide for details

*Not all fabrics are available in all zones

Control System and Top Treatment Compatibility Chart - High Torque Motors

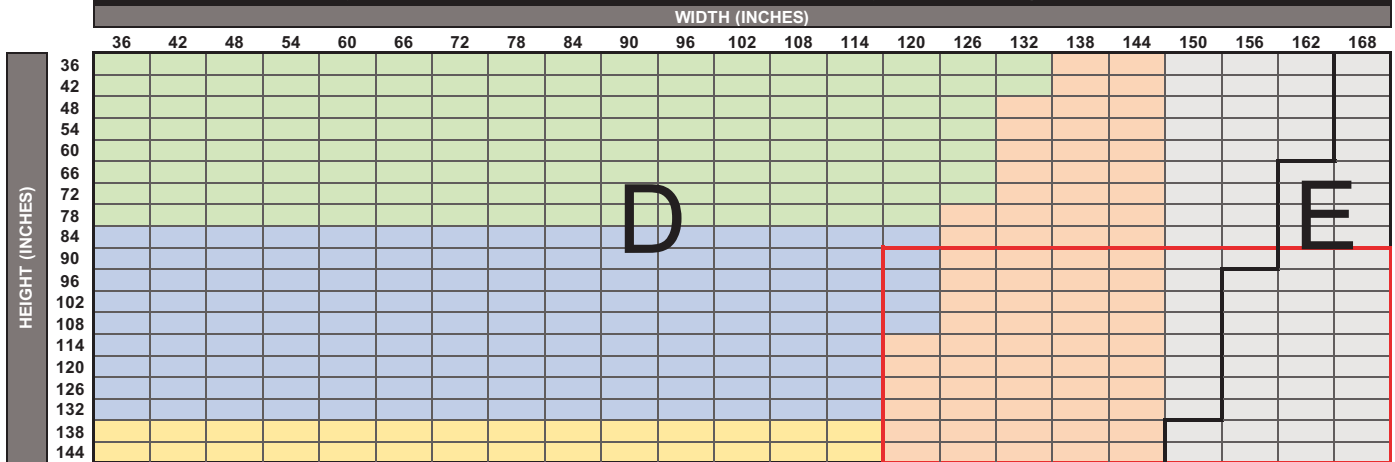

Control Systems (Minimum height for all Control Systems is 12")		Minimum Width (Single Panel)	Overall Minimum Width (2-on-1)	Specification Zone(s)*	Top Treatment
Lithium-ion Motors	Bliss™ 3.0 Li-Ion	32"	65"	D & E	All
	Sonessé® 40 WireFree™ RTS Li-Ion	31"	63"	D	
AC Motors	Bliss™ 10.0 AC	35"	NA	D & E	Open Roll, Fabric Cornice, and 4" Fascia
	Sonessé® 50 RTS AC (120V)	33"	NA	D & E	
	Sonessé® Ultra 50 AC (120V)	39"	NA	D & E	

*Not all fabrics are available in all zones

PRODUCT SIZE SPECIFICATIONS – CONTINUOUS LOOP CONTROL & AUTOMATION

Collection Code	Collection Name	Max Width Non-Railroaded ** (inches)	Max Width Railroaded (inches)	Available with Seam
RD8	Brilliance	118	NA	No

**To determine the maximum width for continuous Fabric Cornices, subtract 4 inches from the maximum non-railroad width.

- Railroad Fabrics (turned width for length) will have a visible seam when fabricated longer than the maximum roll width less 16".
- Red Box in spec chart indicates shade sizes Heat Sealed Hem Bar is recommended. For Continuous Loop Control, metal chain is also recommended for these sizes.

Top Treatment	Legend			
Medium Cassette				
3" Fascia				
Large Cassette				
Square Cassette				
Fabric Cornice				
4" Fascia				
Open Roll				

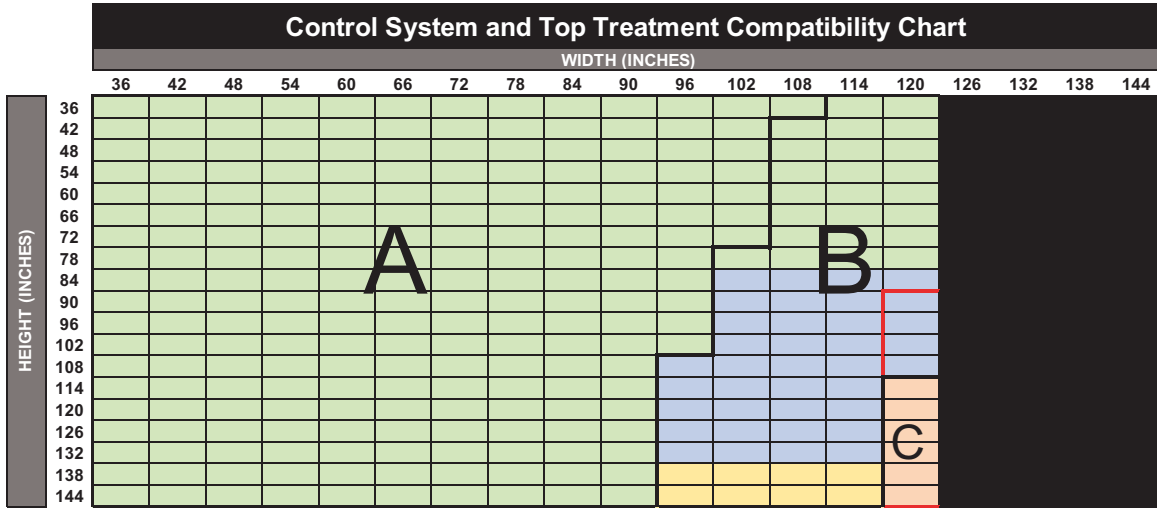

Control Systems (Minimum height for all Control Systems is 12")		Minimum Width (Single Panel)	Overall Minimum Width (2-on-1)	Specification Zone(s)*	Top Treatment
Continuous Loop Control	Continuous Loop Control (Maximum height for 12" width is 60")	12"	24"	A, B & C	All
	**Continuous Loop Control with Spring Assist	60"	NA	A, B & C	Open Roll & 4" Fascia
PowerWand	Powerwand 1.0 Li-Ion	21"	43"	A	All
	Powerwand 2.0 Li-Ion	22"	45"	A & B	(except 3" Fascia)
Lithium-ion Motors	Bliss™ 1.1 Li-Ion	21 1/2"	44"	A	All
	Bliss™ 2.0 Li-Ion	29"	59"	A & B	
	Sonessé® 28 WireFree™ RTS Li-Ion / Sonessé® 28 WireFree™ Zigbee Li-Ion	24 1/2"	50"	A	
	Sonessé® ULTRA 30 WireFree™ RTS Li-Ion	28 1/2"	58"	A & B	
DC Motors	Bliss™ 1.1 DC	16 1/2"	34"	A	All
	Bliss™ 2.0 DC	22 1/2"	46"	A & B	
	Sonessé® 28 WireFree™ RTS DC / Sonessé® 28 WireFree™ Zigbee DC	16 1/2"	34"	A	
	Sonessé® 30 RTS 24v DC	21"	NA	A & B	

**See Spring Assist Section in reference guide for details

*Not all fabrics are available in all zones

Control System and Top Treatment Compatibility Chart - High Torque Motors

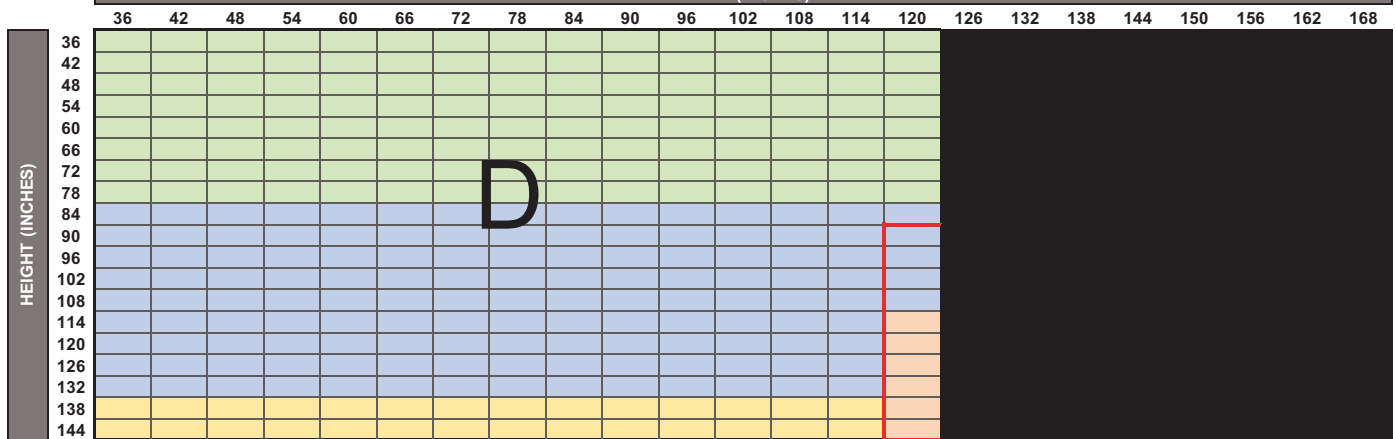

Control Systems (Minimum height for all Control Systems is 12")		Minimum Width (Single Panel)	Overall Minimum Width (2-on-1)	Specification Zone(s)*	Top Treatment
Lithium-ion Motors	Bliss™ 3.0 Li-Ion	32"	65"	D & E	All
	Sonessé® 40 WireFree™ RTS Li-Ion	31"	63"	D	
AC Motors	Bliss™ 10.0 AC	35"	NA	D & E	Open Roll, Fabric Cornice, and 4" Fascia
	Sonessé® 50 RTS AC (120V)	33"	NA	D & E	
	Sonessé® Ultra 50 AC (120V)	39"	NA	D & E	

*Not all fabrics are available in all zones

PRODUCT SIZE SPECIFICATIONS – CONTINUOUS LOOP CONTROL & AUTOMATION

Collection Code	Collection Name	Max Width Non-Railroaded ** (inches)	Max Width Railroaded (inches)	Available with Seam
RB6	Brilliance Blackout	118	NA	No

**To determine the maximum width for continuous Fabric Cornices, subtract 4 inches from the maximum non-railroad width.

· Railroad Fabrics (turned width for length) will have a visible seam when fabricated longer than the maximum roll width less 16".
 · Red Box in spec chart indicates shade sizes Heat Sealed Hem Bar is recommended. For Continuous Loop Control, metal chain is also recommended for these sizes.

Top Treatment	Legend			
Medium Cassette				
3" Fascia				
Large Cassette				
Square Cassette				
Fabric Cornice				
4" Fascia				
Open Roll				

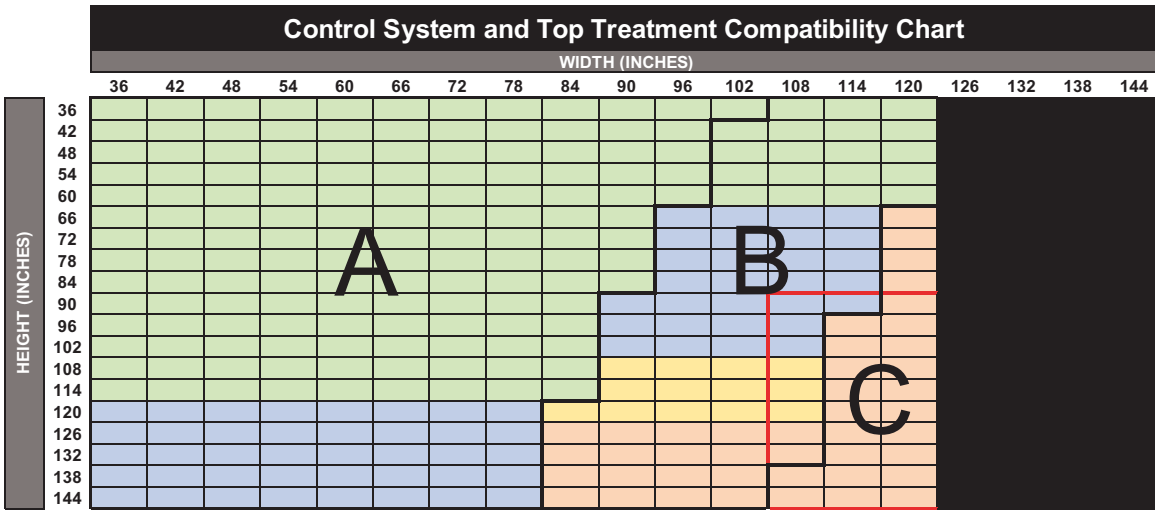

Control Systems (Minimum height for all Control Systems is 12")		Minimum Width (Single Panel)	Overall Minimum Width (2-on-1)	Specification Zone(s)*	Top Treatment
Continuous Loop Control	Continuous Loop Control (Maximum height for 12" width is 60")	12"	24"	A, B & C	All
	**Continuous Loop Control with Spring Assist	60"	NA	A, B & C	Open Roll & 4" Fascia
PowerWand	Powerwand 1.0 Li-Ion	21"	43"	A	All
	Powerwand 2.0 Li-Ion	22"	45"	A & B	(except 3" Fascia)
Lithium-ion Motors	Bliss™ 1.1 Li-Ion	21 1/2"	44"	A	All
	Bliss™ 2.0 Li-Ion	29"	59"	A & B	
	Sonessé® 28 WireFree™ RTS Li-Ion / Sonessé® 28 WireFree™ Zigbee Li-Ion	24 1/2"	50"	A	
	Sonessé® ULTRA 30 WireFree™ RTS Li-Ion	28 1/2"	58"	A & B	
DC Motors	Bliss™ 1.1 DC	16 1/2"	34"	A	All
	Bliss™ 2.0 DC	22 1/2"	46"	A & B	
	Sonessé® 28 WireFree™ RTS DC / Sonessé® 28 WireFree™ Zigbee DC	16 1/2"	34"	A	
	Sonessé® 30 RTS 24v DC	21"	NA	A & B	

**See Spring Assist Section in reference guide for details

*Not all fabrics are available in all zones

Control System and Top Treatment Compatibility Chart - High Torque Motors

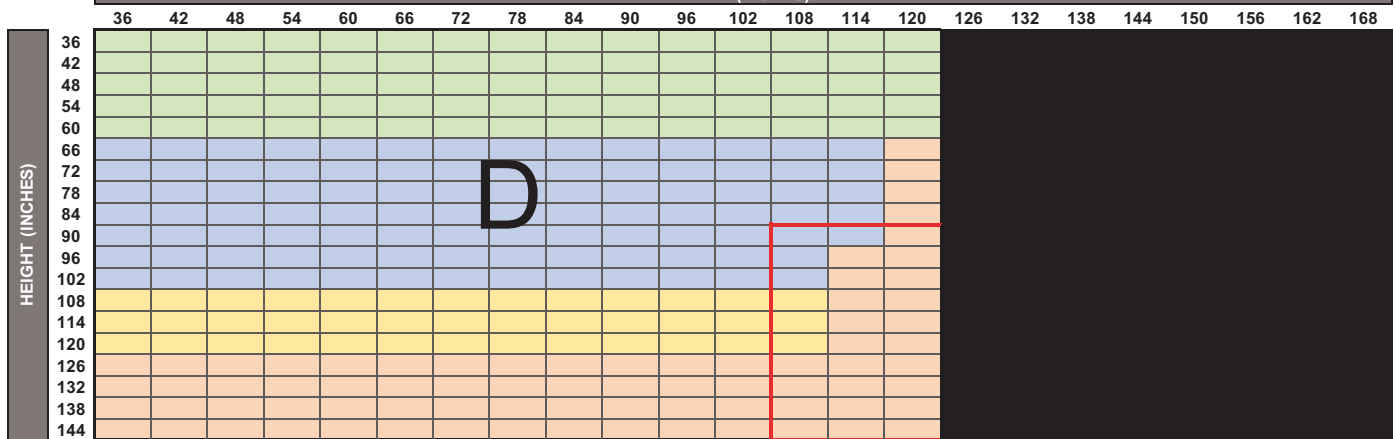

Control Systems (Minimum height for all Control Systems is 12")		Minimum Width (Single Panel)	Overall Minimum Width (2-on-1)	Specification Zone(s)*	Top Treatment
Lithium-ion Motors	Bliss™ 3.0 Li-Ion	32"	65"	D & E	All
	Sonessé® 40 WireFree™ RTS Li-Ion	31"	63"	D	
AC Motors	Bliss™ 10.0 AC	35"	NA	D & E	Open Roll, Fabric Cornice, and 4" Fascia
	Sonessé® 50 RTS AC (120V)	33"	NA	D & E	
	Sonessé® Ultra 50 AC (120V)	39"	NA	D & E	

*Not all fabrics are available in all zones

PRODUCT SIZE SPECIFICATIONS – CONTINUOUS LOOP CONTROL & AUTOMATION

Collection Code	Collection Name	Max Width Non-Railroaded ** (inches)	Max Width Railroaded (inches)	Available with Seam
AF040	Burton	110	NA	No

**To determine the maximum width for continuous Fabric Cornices, subtract 4 inches from the maximum non-railroad width.

· Railroad Fabrics (turned width for length) will have a visible seam when fabricated longer than the maximum roll width less 16".
 · Red Box in spec chart indicates shade sizes Heat Sealed Hem Bar is recommended. For Continuous Loop Control, metal chain is also recommended for these sizes.

Top Treatment	Legend			
Medium Cassette				
3" Fascia				
Large Cassette				
Square Cassette				
Fabric Cornice				
4" Fascia				
Open Roll				

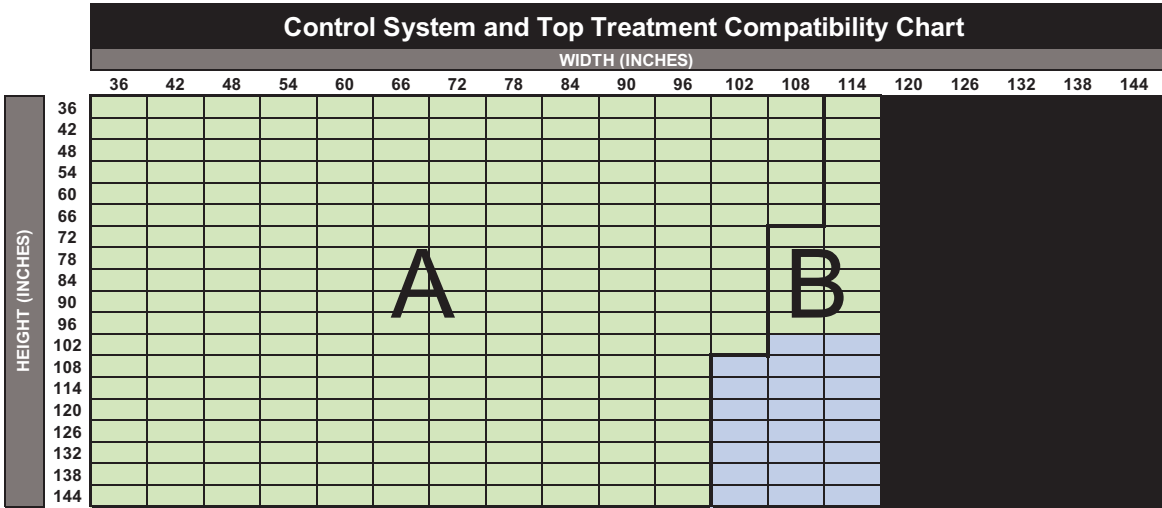

Control Systems (Minimum height for all Control Systems is 12")		Minimum Width (Single Panel)	Overall Minimum Width (2-on-1)	Specification Zone(s)*	Top Treatment
Continuous Loop Control	Continuous Loop Control (Maximum height for 12" width is 60")	12"	24"	A, B & C	All
	**Continuous Loop Control with Spring Assist	60"	NA	A, B & C	Open Roll & 4" Fascia
PowerWand	Powerwand 1.0 Li-Ion	21"	43"	A	All
	Powerwand 2.0 Li-Ion	22"	45"	A & B	(except 3" Fascia)
Lithium-ion Motors	Bliss™ 1.1 Li-Ion	21 1/2"	44"	A	All
	Bliss™ 2.0 Li-Ion	29"	59"	A & B	
	Sonessé® 28 WireFree™ RTS Li-Ion / Sonessé® 28 WireFree™ Zigbee Li-Ion	24 1/2"	50"	A	
	Sonessé® ULTRA 30 WireFree™ RTS Li-Ion	28 1/2"	58"	A & B	
DC Motors	Bliss™ 1.1 DC	16 1/2"	34"	A	All
	Bliss™ 2.0 DC	22 1/2"	46"	A & B	
	Sonessé® 28 WireFree™ RTS DC / Sonessé® 28 WireFree™ Zigbee DC	16 1/2"	34"	A	
	Sonessé® 30 RTS 24v DC	21"	NA	A & B	

**See Spring Assist Section in reference guide for details

*Not all fabrics are available in all zones

Control System and Top Treatment Compatibility Chart - High Torque Motors

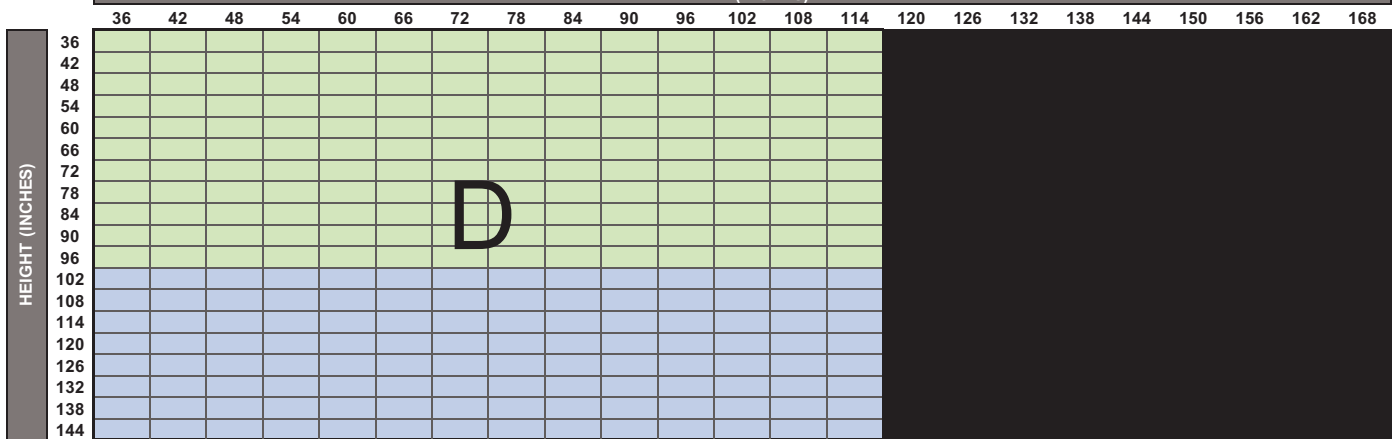

Control Systems (Minimum height for all Control Systems is 12")		Minimum Width (Single Panel)	Overall Minimum Width (2-on-1)	Specification Zone(s)*	Top Treatment
Lithium-ion Motors	Bliss™ 3.0 Li-Ion	32"	65"	D & E	All
	Sonessé® 40 WireFree™ RTS Li-Ion	31"	63"	D	
AC Motors	Bliss™ 10.0 AC	35"	NA	D & E	Open Roll, Fabric Cornice, and 4" Fascia
	Sonessé® 50 RTS AC (120V)	33"	NA	D & E	
	Sonessé® Ultra 50 AC (120V)	39"	NA	D & E	

*Not all fabrics are available in all zones

PRODUCT SIZE SPECIFICATIONS – CONTINUOUS LOOP CONTROL & AUTOMATION

Collection Code	Collection Name	Max Width Non-Railroaded ** (inches)	Max Width Railroaded (inches)	Available with Seam
RD6	Carrara	110	NA	No

**To determine the maximum width for continuous Fabric Cornices, subtract 4 inches from the maximum non-railroad width.

- Railroad Fabrics (turned width for length) will have a visible seam when fabricated longer than the maximum roll width less 16".
- Red Box in spec chart indicates shade sizes Heat Sealed Hem Bar is recommended. For Continuous Loop Control, metal chain is also recommended for these sizes.

Top Treatment	Legend			
Medium Cassette				
3" Fascia				
Large Cassette				
Square Cassette				
Fabric Cornice				
4" Fascia				
Open Roll				

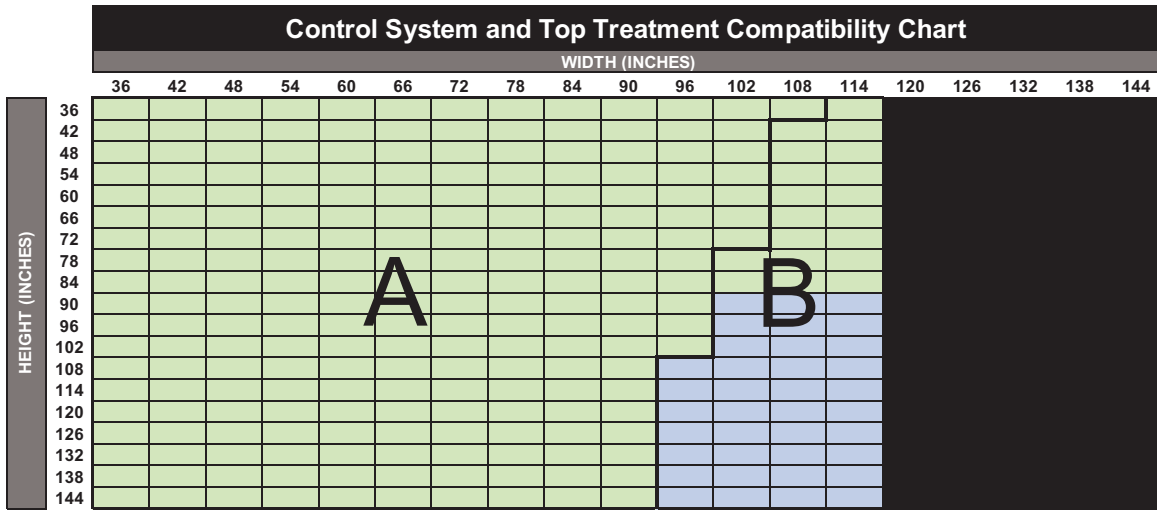

Control Systems (Minimum height for all Control Systems is 12")		Minimum Width (Single Panel)	Overall Minimum Width (2-on-1)	Specification Zone(s)*	Top Treatment
Continuous Loop Control	Continuous Loop Control (Maximum height for 12" width is 60")	12"	24"	A, B & C	All
	**Continuous Loop Control with Spring Assist	60"	NA	A, B & C	Open Roll & 4" Fascia
PowerWand	Powerwand 1.0 Li-Ion	21"	43"	A	All
	Powerwand 2.0 Li-Ion	22"	45"	A & B	(except 3" Fascia)
Lithium-ion Motors	Bliss™ 1.1 Li-Ion	21 1/2"	44"	A	All
	Bliss™ 2.0 Li-Ion	29"	59"	A & B	
	Sonessé® 28 WireFree™ RTS Li-Ion / Sonessé® 28 WireFree™ Zigbee Li-Ion	24 1/2"	50"	A	
	Sonessé® ULTRA 30 WireFree™ RTS Li-Ion	28 1/2"	58"	A & B	
DC Motors	Bliss™ 1.1 DC	16 1/2"	34"	A	All
	Bliss™ 2.0 DC	22 1/2"	46"	A & B	
	Sonessé® 28 WireFree™ RTS DC / Sonessé® 28 WireFree™ Zigbee DC	16 1/2"	34"	A	
	Sonessé® 30 RTS 24v DC	21"	NA	A & B	

**See Spring Assist Section in reference guide for details

*Not all fabrics are available in all zones

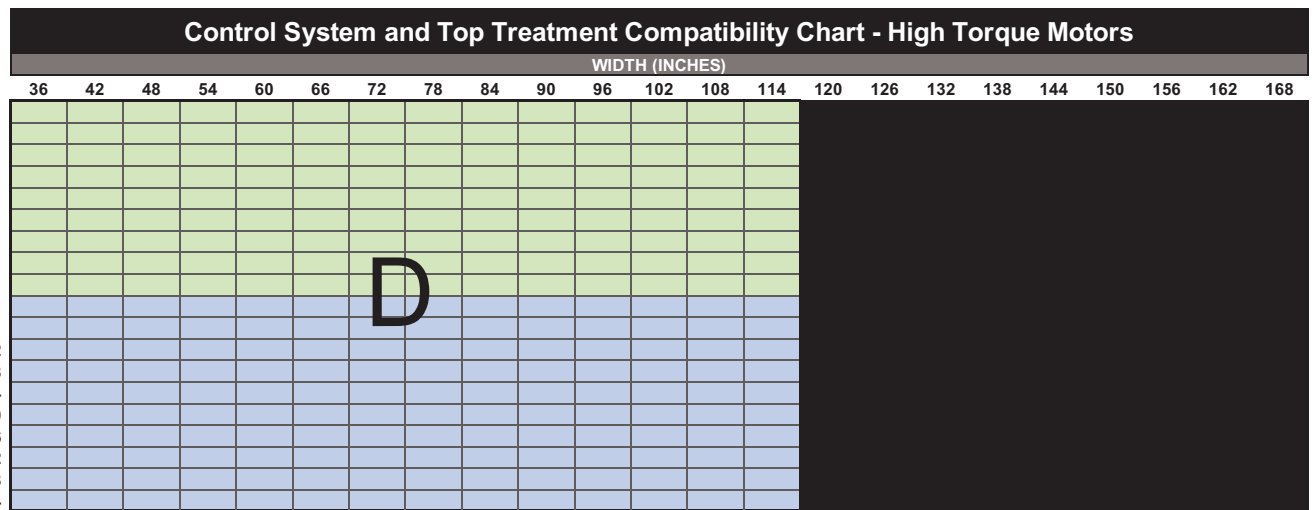

Control Systems (Minimum height for all Control Systems is 12")		Minimum Width (Single Panel)	Overall Minimum Width (2-on-1)	Specification Zone(s)*	Top Treatment
Lithium-ion Motors	Bliss™ 3.0 Li-Ion	32"	65"	D & E	All
	Sonessé® 40 WireFree™ RTS Li-Ion	31"	63"	D	
AC Motors	Bliss™ 10.0 AC	35"	NA	D & E	Open Roll, Fabric Cornice, and 4" Fascia
	Sonessé® 50 RTS AC (120V)	33"	NA	D & E	
	Sonessé® Ultra 50 AC (120V)	39"	NA	D & E	

*Not all fabrics are available in all zones

PRODUCT SIZE SPECIFICATIONS – CONTINUOUS LOOP CONTROL & AUTOMATION

Collection Code	Collection Name	Max Width Non-Railroaded ** (inches)	Max Width Railroaded (inches)	Available with Seam
RB4	Carrara Blackout	110	NA	No

**To determine the maximum width for continuous Fabric Cornices, subtract 4 inches from the maximum non-railroad width.

- Railroad Fabrics (turned width for length) will have a visible seam when fabricated longer than the maximum roll width less 16".
- Red Box in spec chart indicates shade sizes Heat Sealed Hem Bar is recommended. For Continuous Loop Control, metal chain is also recommended for these sizes.

Top Treatment	Legend			
Medium Cassette				
3" Fascia				
Large Cassette				
Square Cassette				
Fabric Cornice				
4" Fascia				
Open Roll				

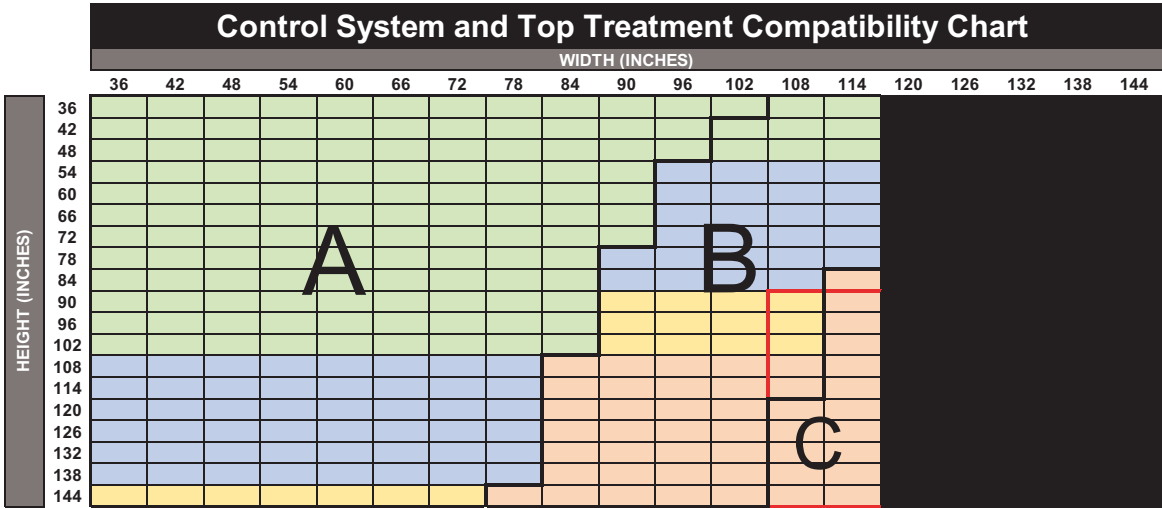

Control Systems (Minimum height for all Control Systems is 12")		Minimum Width (Single Panel)	Overall Minimum Width (2-on-1)	Specification Zone(s)*	Top Treatment
Continuous Loop Control	Continuous Loop Control (Maximum height for 12" width is 60")	12"	24"	A, B & C	All
	**Continuous Loop Control with Spring Assist	60"	NA	A, B & C	Open Roll & 4" Fascia
PowerWand	Powerwand 1.0 Li-Ion	21"	43"	A	All
	Powerwand 2.0 Li-Ion	22"	45"	A & B	(except 3" Fascia)
Lithium-ion Motors	Bliss™ 1.1 Li-Ion	21 1/2"	44"	A	All
	Bliss™ 2.0 Li-Ion	29"	59"	A & B	
	Sonessé® 28 WireFree™ RTS Li-Ion / Sonessé® 28 WireFree™ Zigbee Li-Ion	24 1/2"	50"	A	
	Sonessé® ULTRA 30 WireFree™ RTS Li-Ion	28 1/2"	58"	A & B	
DC Motors	Bliss™ 1.1 DC	16 1/2"	34"	A	All
	Bliss™ 2.0 DC	22 1/2"	46"	A & B	
	Sonessé® 28 WireFree™ RTS DC / Sonessé® 28 WireFree™ Zigbee DC	16 1/2"	34"	A	
	Sonessé® 30 RTS 24v DC	21"	NA	A & B	

**See Spring Assist Section in reference guide for details

*Not all fabrics are available in all zones

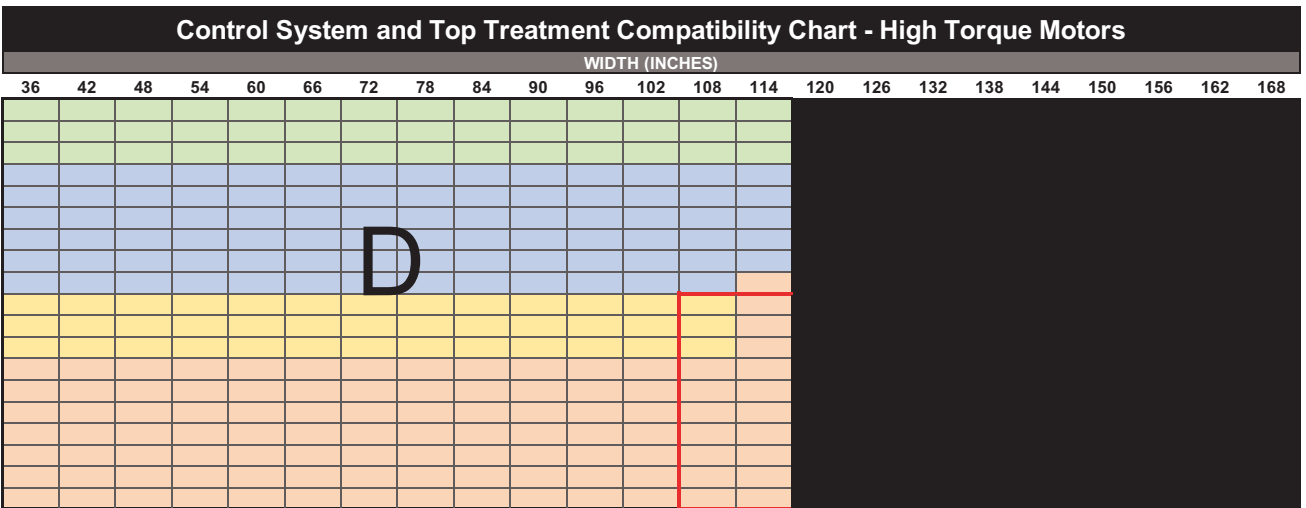

Control Systems (Minimum height for all Control Systems is 12")		Minimum Width (Single Panel)	Overall Minimum Width (2-on-1)	Specification Zone(s)*	Top Treatment
Lithium-ion Motors	Bliss™ 3.0 Li-Ion	32"	65"	D & E	All
	Sonessé® 40 WireFree™ RTS Li-Ion	31"	63"	D	
AC Motors	Bliss™ 10.0 AC	35"	NA	D & E	Open Roll, Fabric Cornice, and 4" Fascia
	Sonessé® 50 RTS AC (120V)	33"	NA	D & E	
	Sonessé® Ultra 50 AC (120V)	39"	NA	D & E	

*Not all fabrics are available in all zones

PRODUCT SIZE SPECIFICATIONS – CONTINUOUS LOOP CONTROL & AUTOMATION

Collection Code	Collection Name	Max Width Non-Railroaded ** (inches)	Max Width Railroaded (inches)	Available with Seam
RB16	Chesapeake Blackout	98	NA	No

**To determine the maximum width for continuous Fabric Cornices, subtract 4 inches from the maximum non-railroad width.

- Railroad Fabrics (turned width for length) will have a visible seam when fabricated longer than the maximum roll width less 16".
- Red Box in spec chart indicates shade sizes Heat Sealed Hem Bar is recommended. For Continuous Loop Control, metal chain is also recommended for these sizes.

Top Treatment	Legend			
Medium Cassette				
3" Fascia				
Large Cassette				
Square Cassette				
Fabric Cornice				
4" Fascia				
Open Roll				

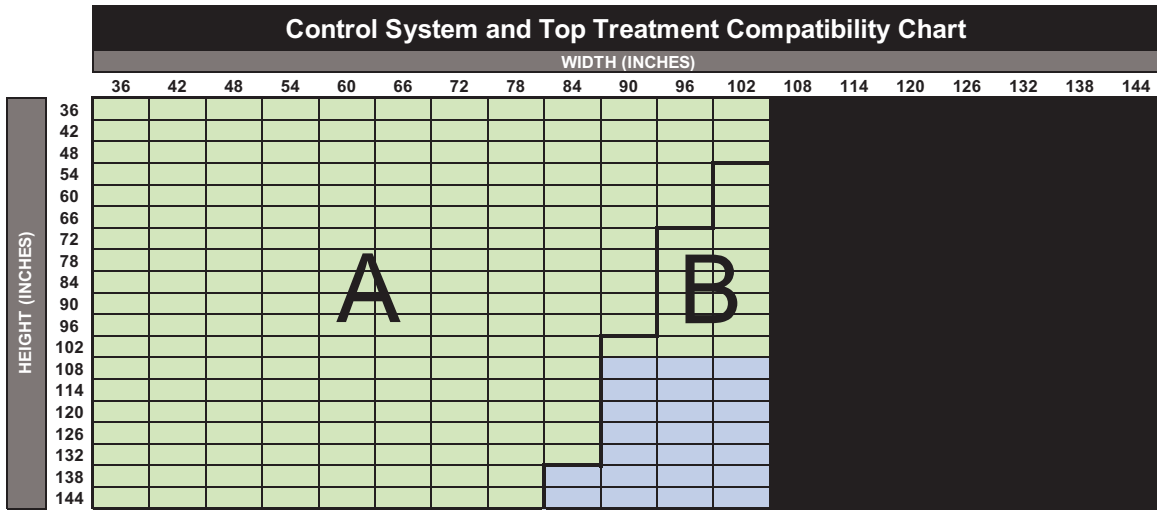

Control Systems (Minimum height for all Control Systems is 12")		Minimum Width (Single Panel)	Overall Minimum Width (2-on-1)	Specification Zone(s)*	Top Treatment
Continuous Loop Control	Continuous Loop Control (Maximum height for 12" width is 60")	12"	24"	A, B & C	All
	**Continuous Loop Control with Spring Assist	60"	NA	A, B & C	Open Roll & 4" Fascia
PowerWand	Powerwand 1.0 Li-Ion	21"	43"	A	All
	Powerwand 2.0 Li-Ion	22"	45"	A & B	(except 3" Fascia)
Lithium-ion Motors	Bliss™ 1.1 Li-Ion	21 1/2"	44"	A	All
	Bliss™ 2.0 Li-Ion	29"	59"	A & B	
	Sonesse® 28 WireFree™ RTS Li-Ion / Sonesse® 28 WireFree™ Zigbee Li-Ion	24 1/2"	50"	A	
	Sonesse® ULTRA 30 WireFree™ RTS Li-Ion	28 1/2"	58"	A & B	
DC Motors	Bliss™ 1.1 DC	16 1/2"	34"	A	All
	Bliss™ 2.0 DC	22 1/2"	46"	A & B	
	Sonesse® 28 WireFree™ RTS DC / Sonesse® 28 WireFree™ Zigbee DC	16 1/2"	34"	A	
	Sonesse® 30 RTS 24v DC	21"	NA	A & B	

**See Spring Assist Section in reference guide for details

*Not all fabrics are available in all zones

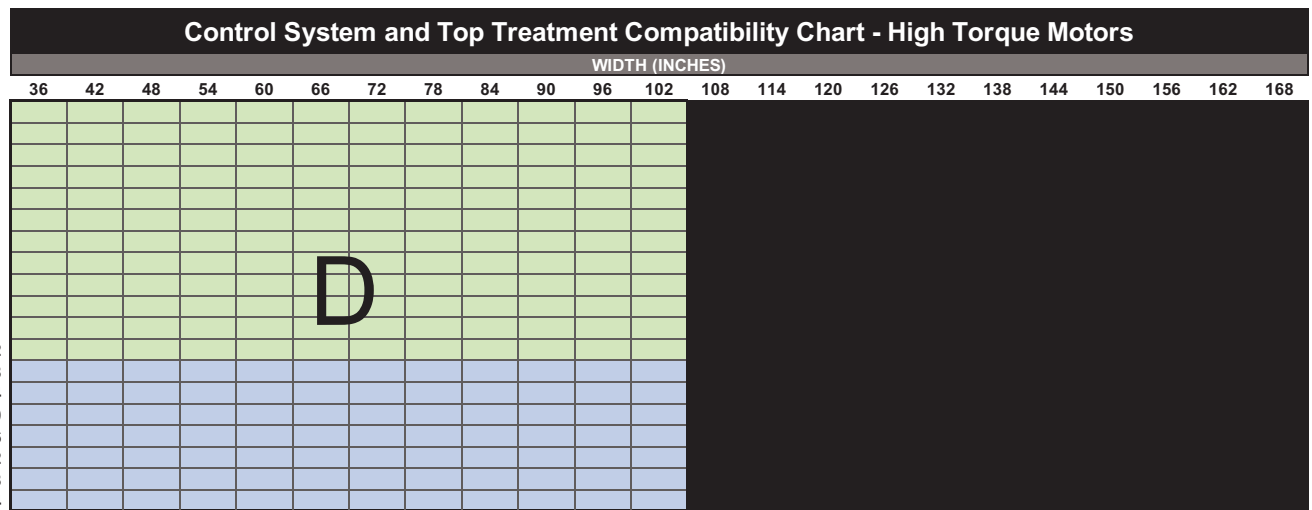

Control Systems (Minimum height for all Control Systems is 12")		Minimum Width (Single Panel)	Overall Minimum Width (2-on-1)	Specification Zone(s)*	Top Treatment
Lithium-ion Motors	Bliss™ 3.0 Li-Ion	32"	65"	D & E	All
	Sonesse® 40 WireFree™ RTS Li-Ion	31"	63"	D	
AC Motors	Bliss™ 10.0 AC	35"	NA	D & E	Open Roll, Fabric Cornice, and 4" Fascia
	Sonesse® 50 RTS AC (120V)	33"	NA	D & E	
	Sonesse® Ultra 50 AC (120V)	39"	NA	D & E	

*Not all fabrics are available in all zones

PRODUCT SIZE SPECIFICATIONS – CONTINUOUS LOOP CONTROL & AUTOMATION

Collection Code	Collection Name	Max Width Non-Railroaded ** (inches)	Max Width Railroaded (inches)	Available with Seam
RD7	Claudio	110	NA	No

**To determine the maximum width for continuous Fabric Cornices, subtract 4 inches from the maximum non-railroad width.

- Railroad Fabrics (turned width for length) will have a visible seam when fabricated longer than the maximum roll width less 16".
- Red Box in spec chart indicates shade sizes Heat Sealed Hem Bar is recommended. For Continuous Loop Control, metal chain is also recommended for these sizes.

Top Treatment	Legend			
Medium Cassette				
3" Fascia				
Large Cassette				
Square Cassette				
Fabric Cornice				
4" Fascia				
Open Roll				

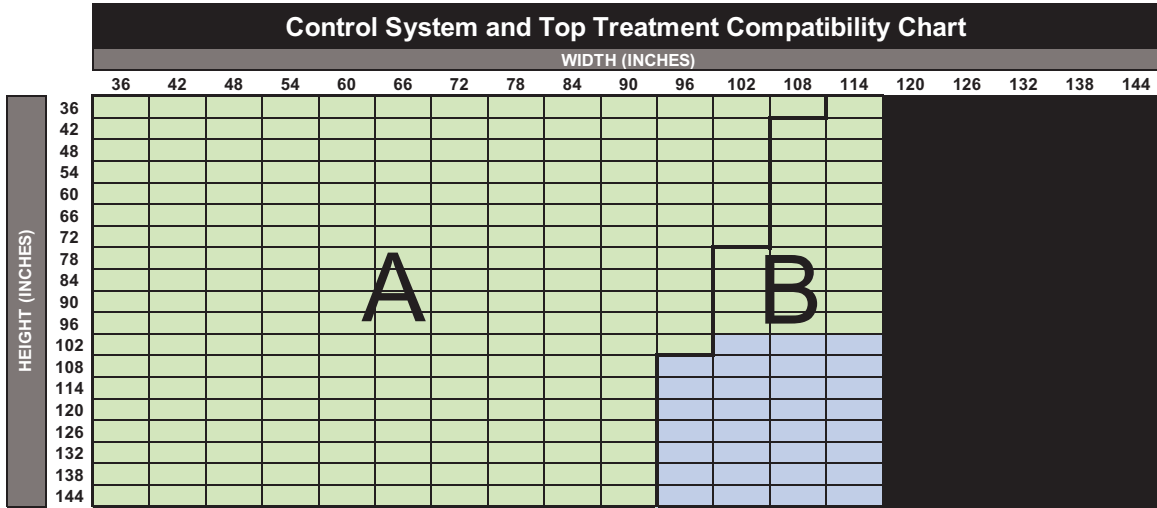

Control Systems (Minimum height for all Control Systems is 12")		Minimum Width (Single Panel)	Overall Minimum Width (2-on-1)	Specification Zone(s)*	Top Treatment
Continuous Loop Control	Continuous Loop Control (Maximum height for 12" width is 60")	12"	24"	A, B & C	All
	**Continuous Loop Control with Spring Assist	60"	NA	A, B & C	Open Roll & 4" Fascia
PowerWand	Powerwand 1.0 Li-Ion	21"	43"	A	All
	Powerwand 2.0 Li-Ion	22"	45"	A & B	(except 3" Fascia)
Lithium-ion Motors	Bliss™ 1.1 Li-Ion	21 1/2"	44"	A	All
	Bliss™ 2.0 Li-Ion	29"	59"	A & B	
	Sonessé® 28 WireFree™ RTS Li-Ion / Sonessé® 28 WireFree™ Zigbee Li-Ion	24 1/2"	50"	A	
	Sonessé® ULTRA 30 WireFree™ RTS Li-Ion	28 1/2"	58"	A & B	
DC Motors	Bliss™ 1.1 DC	16 1/2"	34"	A	All
	Bliss™ 2.0 DC	22 1/2"	46"	A & B	
	Sonessé® 28 WireFree™ RTS DC / Sonessé® 28 WireFree™ Zigbee DC	16 1/2"	34"	A	
	Sonessé® 30 RTS 24v DC	21"	NA	A & B	

**See Spring Assist Section in reference guide for details

*Not all fabrics are available in all zones

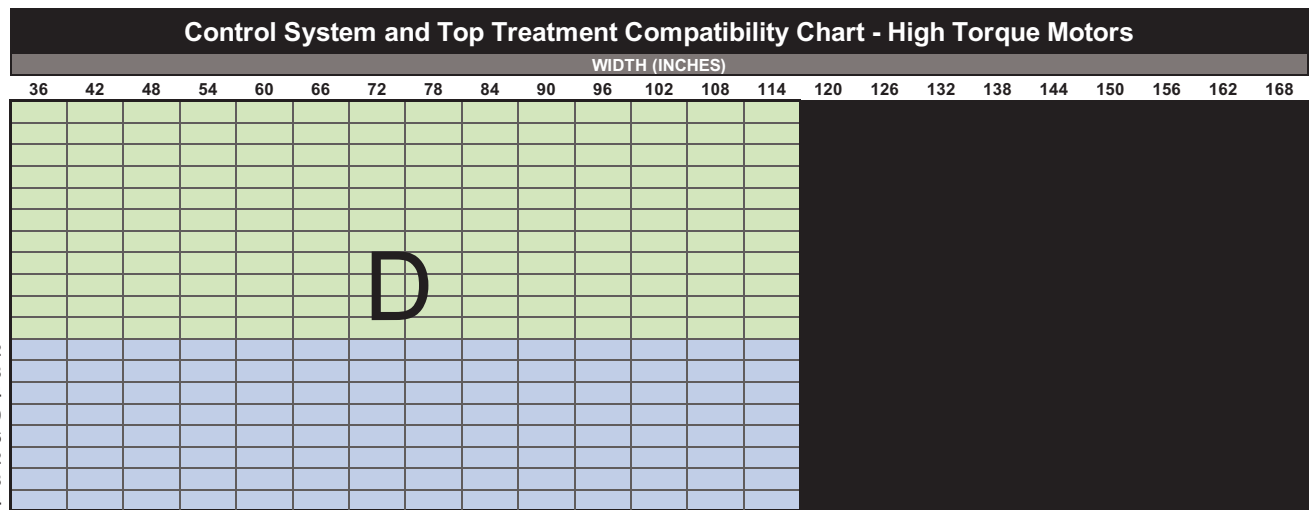

Control Systems (Minimum height for all Control Systems is 12")		Minimum Width (Single Panel)	Overall Minimum Width (2-on-1)	Specification Zone(s)*	Top Treatment
Lithium-ion Motors	Bliss™ 3.0 Li-Ion	32"	65"	D & E	All
	Sonessé® 40 WireFree™ RTS Li-Ion	31"	63"	D	
AC Motors	Bliss™ 10.0 AC	35"	NA	D & E	Open Roll, Fabric Cornice, and 4" Fascia
	Sonessé® 50 RTS AC (120V)	33"	NA	D & E	
	Sonessé® Ultra 50 AC (120V)	39"	NA	D & E	

*Not all fabrics are available in all zones

PRODUCT SIZE SPECIFICATIONS – CONTINUOUS LOOP CONTROL & AUTOMATION

Collection Code	Collection Name	Max Width Non-Railroaded ** (inches)	Max Width Railroaded (inches)	Available with Seam
RB5	Claudio Blackout	110	NA	No

**To determine the maximum width for continuous Fabric Cornices, subtract 4 inches from the maximum non-railroad width.

- Railroad Fabrics (turned width for length) will have a visible seam when fabricated longer than the maximum roll width less 16".
- Red Box in spec chart indicates shade sizes Heat Sealed Hem Bar is recommended. For Continuous Loop Control, metal chain is also recommended for these sizes.

Top Treatment	Legend			
Medium Cassette				
3" Fascia				
Large Cassette				
Square Cassette				
Fabric Cornice				
4" Fascia				
Open Roll				

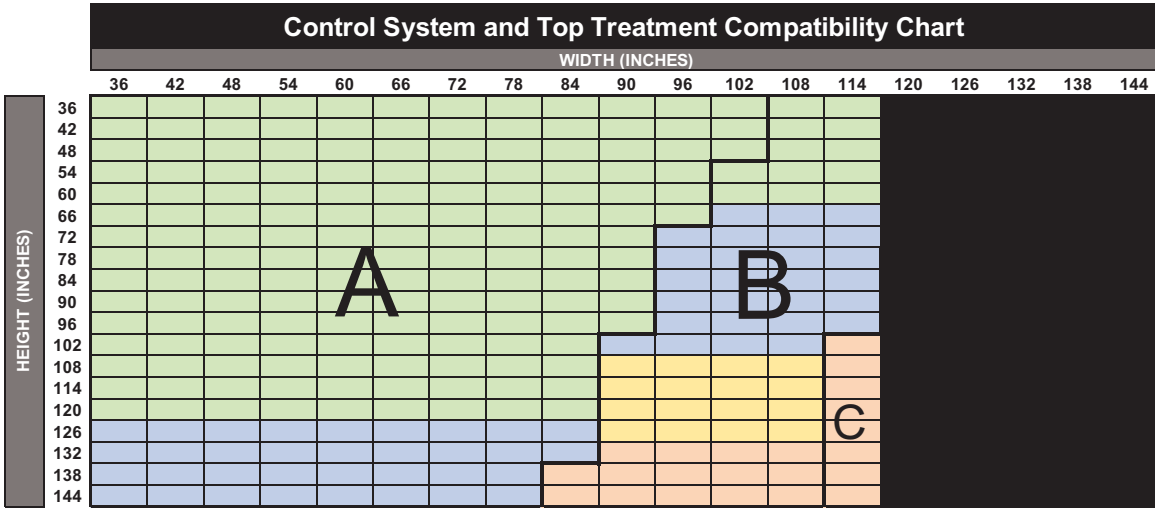

Control Systems (Minimum height for all Control Systems is 12")		Minimum Width (Single Panel)	Overall Minimum Width (2-on-1)	Specification Zone(s)*	Top Treatment
Continuous Loop Control	Continuous Loop Control (Maximum height for 12" width is 60")	12"	24"	A, B & C	All
	**Continuous Loop Control with Spring Assist	60"	NA	A, B & C	Open Roll & 4" Fascia
PowerWand	Powerwand 1.0 Li-Ion	21"	43"	A	All
	Powerwand 2.0 Li-Ion	22"	45"	A & B	(except 3" Fascia)
Lithium-ion Motors	Bliss™ 1.1 Li-Ion	21 1/2"	44"	A	All
	Bliss™ 2.0 Li-Ion	29"	59"	A & B	
	Sonesse® 28 WireFree™ RTS Li-Ion / Sonesse® 28 WireFree™ Zigbee Li-Ion	24 1/2"	50"	A	
	Sonesse® ULTRA 30 WireFree™ RTS Li-Ion	28 1/2"	58"	A & B	
DC Motors	Bliss™ 1.1 DC	16 1/2"	34"	A	All
	Bliss™ 2.0 DC	22 1/2"	46"	A & B	
	Sonesse® 28 WireFree™ RTS DC / Sonesse® 28 WireFree™ Zigbee DC	16 1/2"	34"	A	
	Sonesse® 30 RTS 24v DC	21"	NA	A & B	

**See Spring Assist Section in reference guide for details

*Not all fabrics are available in all zones

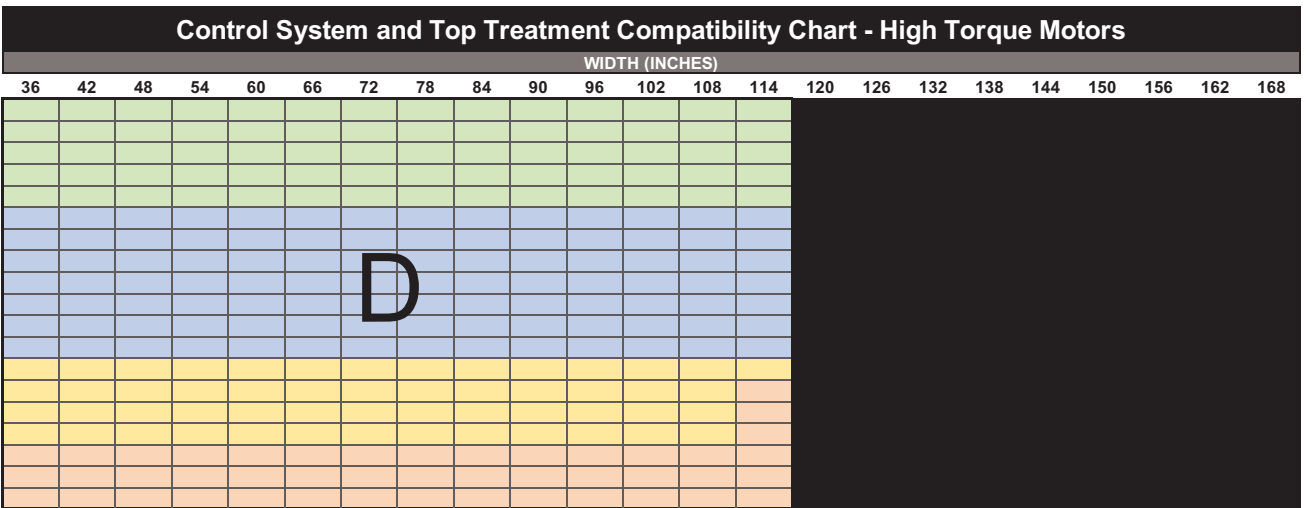

Control Systems (Minimum height for all Control Systems is 12")		Minimum Width (Single Panel)	Overall Minimum Width (2-on-1)	Specification Zone(s)*	Top Treatment
Lithium-ion Motors	Bliss™ 3.0 Li-Ion	32"	65"	D & E	All
	Sonesse® 40 WireFree™ RTS Li-Ion	31"	63"	D	
AC Motors	Bliss™ 10.0 AC	35"	NA	D & E	Open Roll, Fabric Cornice, and 4" Fascia
	Sonesse® 50 RTS AC (120V)	33"	NA	D & E	
	Sonesse® Ultra 50 AC (120V)	39"	NA	D & E	

*Not all fabrics are available in all zones

PRODUCT SIZE SPECIFICATIONS – CONTINUOUS LOOP CONTROL & AUTOMATION

Collection Code	Collection Name	Max Width Non-Railroaded ** (inches)	Max Width Railroaded (inches)	Available with Seam
AB021	Cusco Blackout	110	NA	No

**To determine the maximum width for continuous Fabric Cornices, subtract 4 inches from the maximum non-railroad width.

· Railroad Fabrics (turned width for length) will have a visible seam when fabricated longer than the maximum roll width less 16".
 · Red Box in spec chart indicates shade sizes Heat Sealed Hem Bar is recommended. For Continuous Loop Control, metal chain is also recommended for these sizes.

Top Treatment	Legend			
Medium Cassette				
3" Fascia				
Large Cassette				
Square Cassette				
Fabric Cornice				
4" Fascia				
Open Roll				

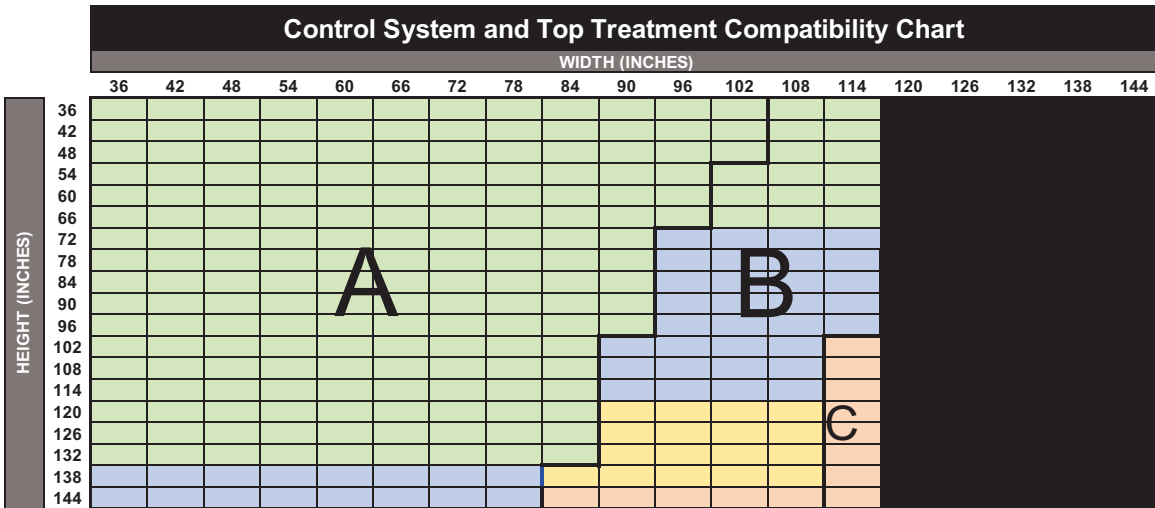

Control Systems (Minimum height for all Control Systems is 12")		Minimum Width (Single Panel)	Overall Minimum Width (2-on-1)	Specification Zone(s)*	Top Treatment
Continuous Loop Control	Continuous Loop Control (Maximum height for 12" width is 60")	12"	24"	A, B & C	All
	**Continuous Loop Control with Spring Assist	60"	NA	A, B & C	Open Roll & 4" Fascia
PowerWand	Powerwand 1.0 Li-Ion	21"	43"	A	All
	Powerwand 2.0 Li-Ion	22"	45"	A & B	(except 3" Fascia)
Lithium-ion Motors	Bliss™ 1.1 Li-Ion	21 1/2"	44"	A	All
	Bliss™ 2.0 Li-Ion	29"	59"	A & B	
	Sonessé® 28 WireFree™ RTS Li-Ion / Sonessé® 28 WireFree™ Zigbee Li-Ion	24 1/2"	50"	A	
	Sonessé® ULTRA 30 WireFree™ RTS Li-Ion	28 1/2"	58"	A & B	
DC Motors	Bliss™ 1.1 DC	16 1/2"	34"	A	All
	Bliss™ 2.0 DC	22 1/2"	46"	A & B	
	Sonessé® 28 WireFree™ RTS DC / Sonessé® 28 WireFree™ Zigbee DC	16 1/2"	34"	A	
	Sonessé® 30 RTS 24v DC	21"	NA	A & B	

**See Spring Assist Section in reference guide for details

*Not all fabrics are available in all zones

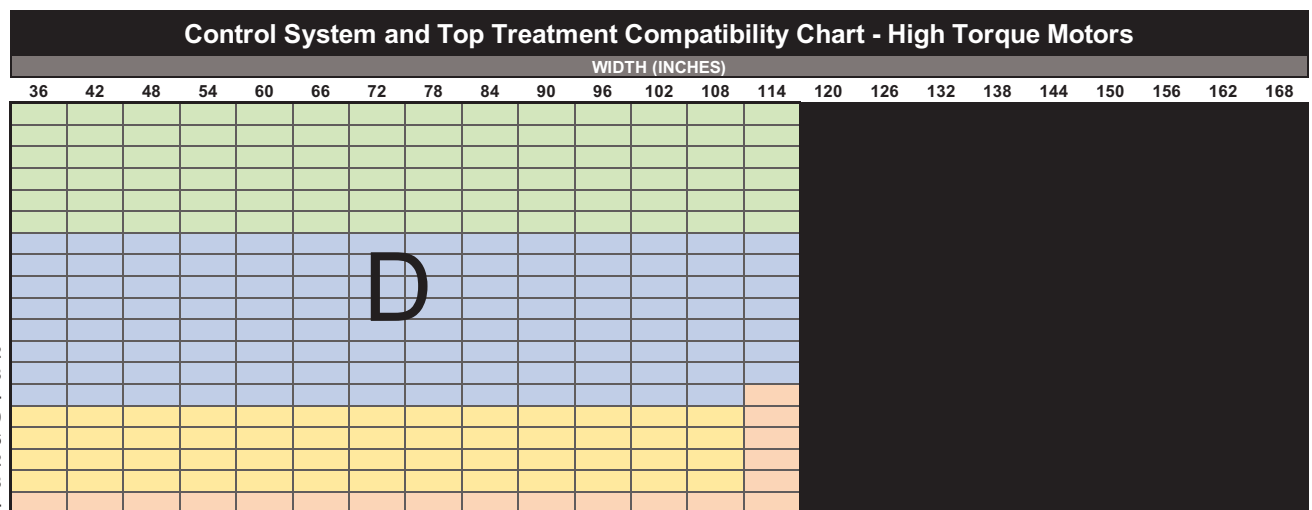

Control Systems (Minimum height for all Control Systems is 12")		Minimum Width (Single Panel)	Overall Minimum Width (2-on-1)	Specification Zone(s)*	Top Treatment
Lithium-ion Motors	Bliss™ 3.0 Li-Ion	32"	65"	D & E	All
	Sonessé® 40 WireFree™ RTS Li-Ion	31"	63"	D	
AC Motors	Bliss™ 10.0 AC	35"	NA	D & E	Open Roll, Fabric Cornice, and 4" Fascia
	Sonessé® 50 RTS AC (120V)	33"	NA	D & E	
	Sonessé® Ultra 50 AC (120V)	39"	NA	D & E	

*Not all fabrics are available in all zones

PRODUCT SIZE SPECIFICATIONS – CONTINUOUS LOOP CONTROL & AUTOMATION

Collection Code	Collection Name	Max Width Non-Railroaded ** (inches)	Max Width Railroaded (inches)	Available with Seam
RD2	Drizzle	94	168	Yes

**To determine the maximum width for continuous Fabric Cornices, subtract 4 inches from the maximum non-railroad width.

- Railroad Fabrics (turned width for length) will have a visible seam when fabricated longer than the maximum roll width less 16".
- Red Box in spec chart indicates shade sizes Heat Sealed Hem Bar is recommended. For Continuous Loop Control, metal chain is also recommended for these sizes.

Top Treatment	Legend			
Medium Cassette				
3" Fascia				
Large Cassette				
Square Cassette				
Fabric Cornice				
4" Fascia				
Open Roll				

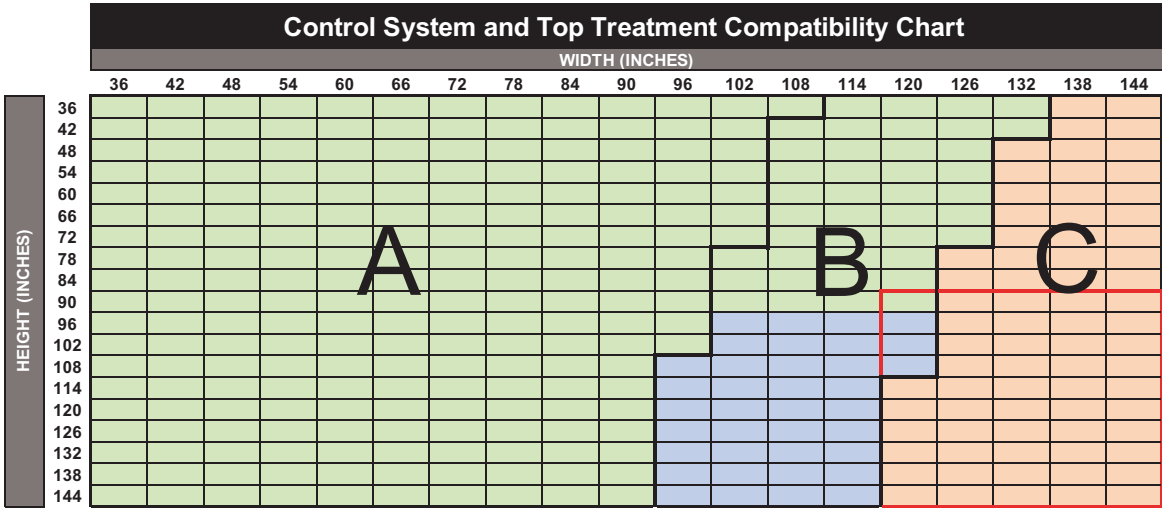

Control Systems (Minimum height for all Control Systems is 12")		Minimum Width (Single Panel)	Overall Minimum Width (2-on-1)	Specification Zone(s)*	Top Treatment
Continuous Loop Control	Continuous Loop Control (Maximum height for 12" width is 60")	12"	24"	A, B & C	All
	**Continuous Loop Control with Spring Assist	60"	NA	A, B & C	Open Roll & 4" Fascia
PowerWand	Powerwand 1.0 Li-Ion	21"	43"	A	All (except 3" Fascia)
	Powerwand 2.0 Li-Ion	22"	45"	A & B	
Lithium-ion Motors	Bliss™ 1.1 Li-Ion	21 1/2"	44"	A	All
	Bliss™ 2.0 Li-Ion	29"	59"	A & B	
	Sonessé® 28 WireFree™ RTS Li-Ion / Sonessé® 28 WireFree™ Zigbee Li-Ion	24 1/2"	50"	A	
	Sonessé® ULTRA 30 WireFree™ RTS Li-Ion	28 1/2"	58"	A & B	
DC Motors	Bliss™ 1.1 DC	16 1/2"	34"	A	All
	Bliss™ 2.0 DC	22 1/2"	46"	A & B	
	Sonessé® 28 WireFree™ RTS DC / Sonessé® 28 WireFree™ Zigbee DC	16 1/2"	34"	A	
	Sonessé® 30 RTS 24v DC	21"	NA	A & B	

**See Spring Assist Section in reference guide for details

*Not all fabrics are available in all zones

Control System and Top Treatment Compatibility Chart - High Torque Motors

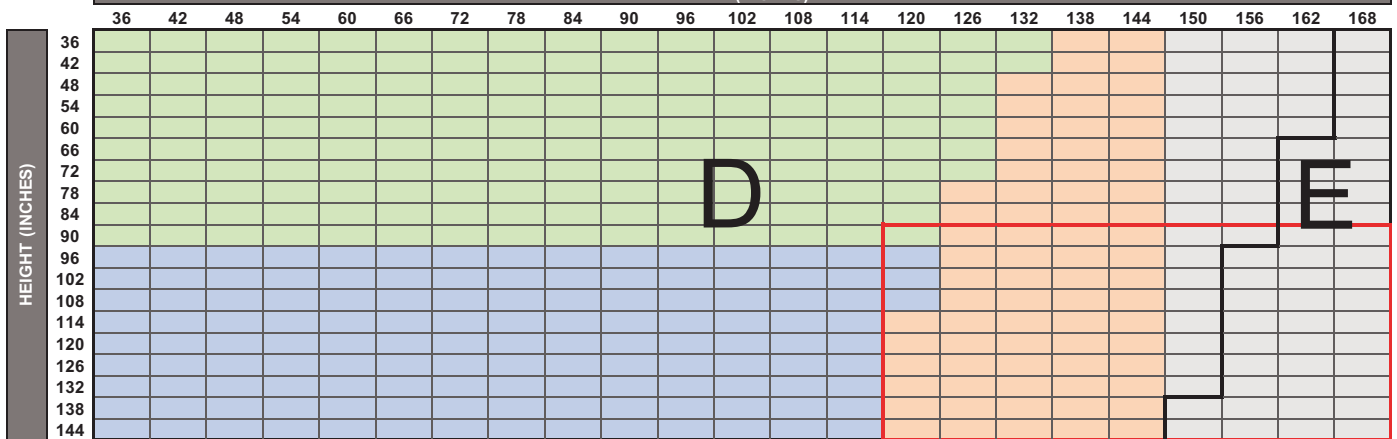

Control Systems (Minimum height for all Control Systems is 12")		Minimum Width (Single Panel)	Overall Minimum Width (2-on-1)	Specification Zone(s)*	Top Treatment
Lithium-ion Motors	Bliss™ 3.0 Li-Ion	32"	65"	D & E	All
	Sonessé® 40 WireFree™ RTS Li-Ion	31"	63"	D	
AC Motors	Bliss™ 10.0 AC	35"	NA	D & E	Open Roll, Fabric Cornice, and 4" Fascia
	Sonessé® 50 RTS AC (120V)	33"	NA	D & E	
	Sonessé® Ultra 50 AC (120V)	39"	NA	D & E	

*Not all fabrics are available in all zones

PRODUCT SIZE SPECIFICATIONS – CONTINUOUS LOOP CONTROL & AUTOMATION

Collection Code	Collection Name	Max Width Non-Railroaded ** (inches)	Max Width Railroaded (inches)	Available with Seam
AF037	Fuji	78 3/4	168	Yes

**To determine the maximum width for continuous Fabric Cornices, subtract 4 inches from the maximum non-railroad width.

- Railroad Fabrics (turned width for length) will have a visible seam when fabricated longer than the maximum roll width less 16".
- Red Box in spec chart indicates shade sizes Heat Sealed Hem Bar is recommended. For Continuous Loop Control, metal chain is also recommended for these sizes.

Top Treatment	Legend			
Medium Cassette				
3" Fascia				
Large Cassette				
Square Cassette				
Fabric Cornice				
4" Fascia				
Open Roll				

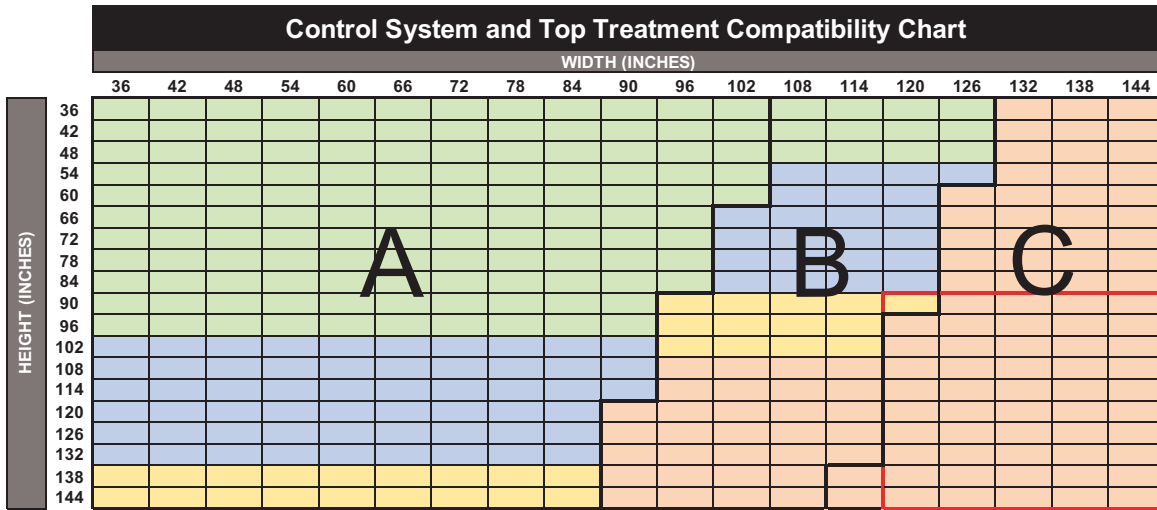

Control Systems (Minimum height for all Control Systems is 12")		Minimum Width (Single Panel)	Overall Minimum Width (2-on-1)	Specification Zone(s)*	Top Treatment
Continuous Loop Control	Continuous Loop Control (Maximum height for 12" width is 60")	12"	24"	A, B & C	All
	**Continuous Loop Control with Spring Assist	60"	NA	A, B & C	Open Roll & 4" Fascia
PowerWand	Powerwand 1.0 Li-Ion	21"	43"	A	All
	Powerwand 2.0 Li-Ion	22"	45"	A & B	(except 3" Fascia)
Lithium-ion Motors	Bliss™ 1.1 Li-Ion	21 1/2"	44"	A	All
	Bliss™ 2.0 Li-Ion	29"	59"	A & B	
	Sonessé® 28 WireFree™ RTS Li-Ion / Sonessé® 28 WireFree™ Zigbee Li-Ion	24 1/2"	50"	A	
	Sonessé® ULTRA 30 WireFree™ RTS Li-Ion	28 1/2"	58"	A & B	
DC Motors	Bliss™ 1.1 DC	16 1/2"	34"	A	All
	Bliss™ 2.0 DC	22 1/2"	46"	A & B	
	Sonessé® 28 WireFree™ RTS DC / Sonessé® 28 WireFree™ Zigbee DC	16 1/2"	34"	A	
	Sonessé® 30 RTS 24v DC	21"	NA	A & B	

**See Spring Assist Section in reference guide for details

*Not all fabrics are available in all zones

Control System and Top Treatment Compatibility Chart - High Torque Motors

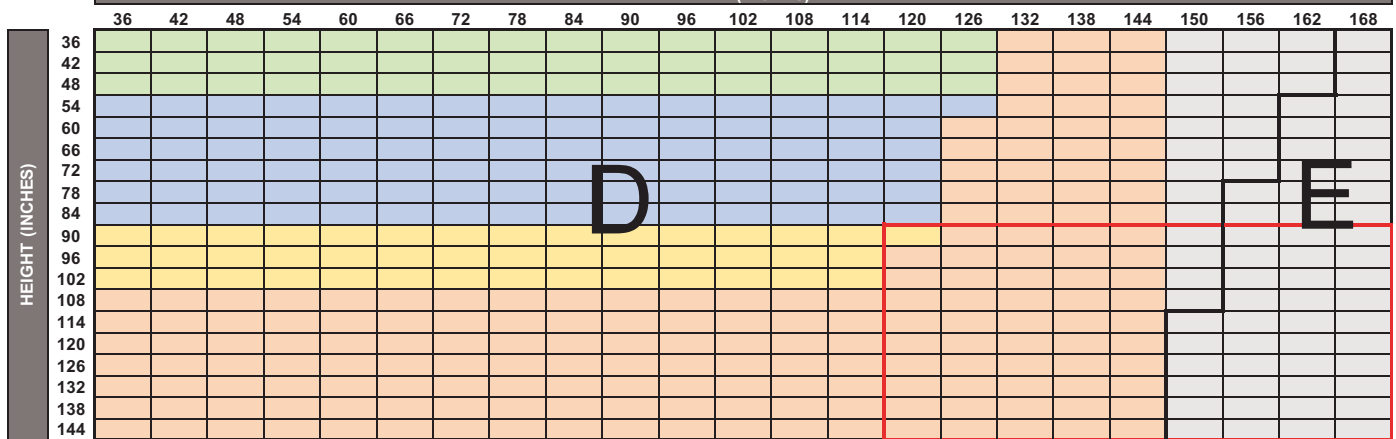

Control Systems (Minimum height for all Control Systems is 12")		Minimum Width (Single Panel)	Overall Minimum Width (2-on-1)	Specification Zone(s)*	Top Treatment
Lithium-ion Motors	Bliss™ 3.0 Li-Ion	32"	65"	D & E	All
	Sonessé® 40 WireFree™ RTS Li-Ion	31"	63"	D	
AC Motors	Bliss™ 10.0 AC	35"	NA	D & E	Open Roll, Fabric Cornice, and 4" Fascia
	Sonessé® 50 RTS AC (120V)	33"	NA	D & E	
	Sonessé® Ultra 50 AC (120V)	39"	NA	D & E	

*Not all fabrics are available in all zones

PRODUCT SIZE SPECIFICATIONS – CONTINUOUS LOOP CONTROL & AUTOMATION

Collection Code	Collection Name	Max Width Non-Railroaded ** (inches)	Max Width Railroaded (inches)	Available with Seam
AB036	Horizon Blackout	110	NA	No

**To determine the maximum width for continuous Fabric Cornices, subtract 4 inches from the maximum non-railroad width.

- Railroad Fabrics (turned width for length) will have a visible seam when fabricated longer than the maximum roll width less 16".
- Red Box in spec chart indicates shade sizes Heat Sealed Hem Bar is recommended. For Continuous Loop Control, metal chain is also recommended for these sizes.

Top Treatment	Legend			
Medium Cassette				
3" Fascia				
Large Cassette				
Square Cassette				
Fabric Cornice				
4" Fascia				
Open Roll				

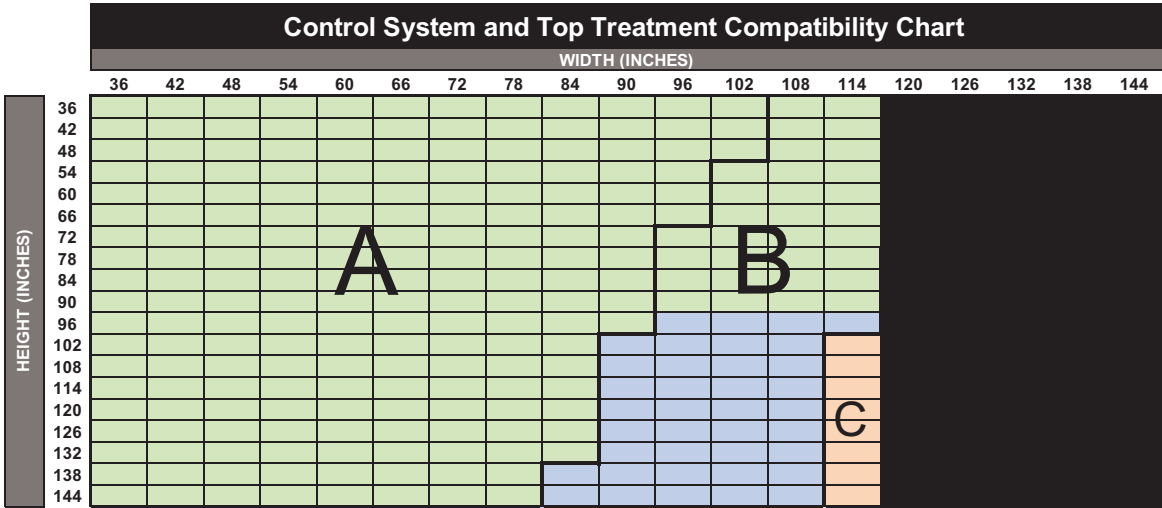

Control Systems (Minimum height for all Control Systems is 12")		Minimum Width (Single Panel)	Overall Minimum Width (2-on-1)	Specification Zone(s)*	Top Treatment
Continuous Loop Control	Continuous Loop Control (Maximum height for 12" width is 60")	12"	24"	A, B & C	All
	**Continuous Loop Control with Spring Assist	60"	NA	A, B & C	Open Roll & 4" Fascia
PowerWand	Powerwand 1.0 Li-Ion	21"	43"	A	All
	Powerwand 2.0 Li-Ion	22"	45"	A & B	(except 3" Fascia)
Lithium-ion Motors	Bliss™ 1.1 Li-Ion	21 1/2"	44"	A	All
	Bliss™ 2.0 Li-Ion	29"	59"	A & B	
	Sonessé® 28 WireFree™ RTS Li-Ion / Sonessé® 28 WireFree™ Zigbee Li-Ion	24 1/2"	50"	A	
	Sonessé® ULTRA 30 WireFree™ RTS Li-Ion	28 1/2"	58"	A & B	
DC Motors	Bliss™ 1.1 DC	16 1/2"	34"	A	All
	Bliss™ 2.0 DC	22 1/2"	46"	A & B	
	Sonessé® 28 WireFree™ RTS DC / Sonessé® 28 WireFree™ Zigbee DC	16 1/2"	34"	A	
	Sonessé® 30 RTS 24v DC	21"	NA	A & B	

**See Spring Assist Section in reference guide for details

*Not all fabrics are available in all zones

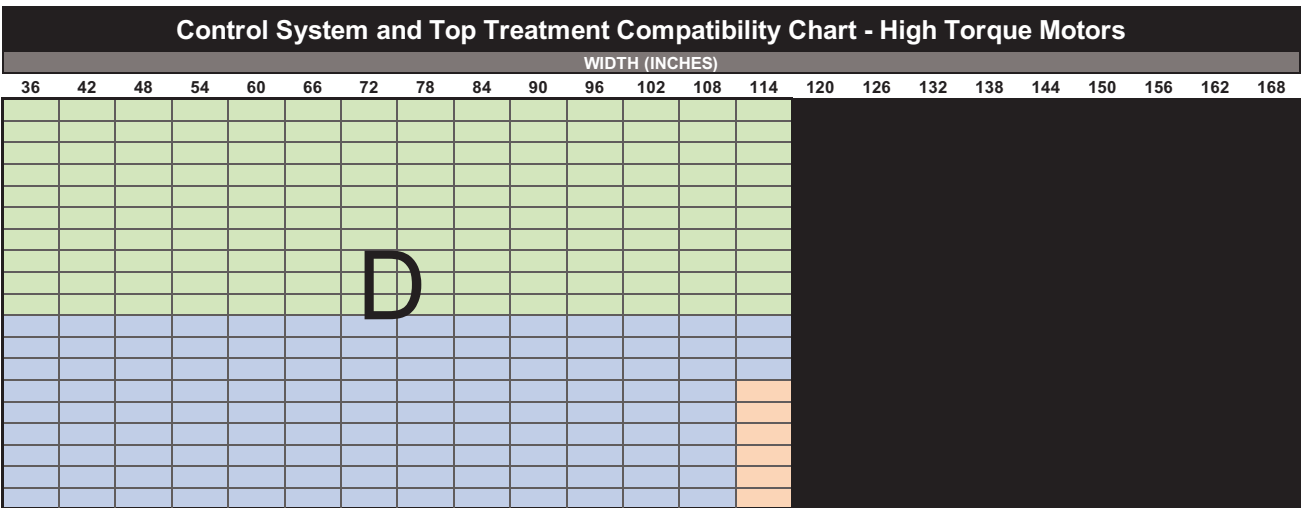

Control Systems (Minimum height for all Control Systems is 12")		Minimum Width (Single Panel)	Overall Minimum Width (2-on-1)	Specification Zone(s)*	Top Treatment
Lithium-ion Motors	Bliss™ 3.0 Li-Ion	32"	65"	D & E	All
	Sonessé® 40 WireFree™ RTS Li-Ion	31"	63"	D	
AC Motors	Bliss™ 10.0 AC	35"	NA	D & E	Open Roll, Fabric Cornice, and 4" Fascia
	Sonessé® 50 RTS AC (120V)	33"	NA	D & E	
	Sonessé® Ultra 50 AC (120V)	39"	NA	D & E	

*Not all fabrics are available in all zones

PRODUCT SIZE SPECIFICATIONS – CONTINUOUS LOOP CONTROL & AUTOMATION

Collection Code	Collection Name	Max Width Non-Railroaded ** (inches)	Max Width Railroaded (inches)	Available with Seam
AF018	Juniper	110	168	Yes

**To determine the maximum width for continuous Fabric Cornices, subtract 4 inches from the maximum non-railroad width.

- Railroad Fabrics (turned width for length) will have a visible seam when fabricated longer than the maximum roll width less 16".
- Red Box in spec chart indicates shade sizes Heat Sealed Hem Bar is recommended. For Continuous Loop Control, metal chain is also recommended for these sizes.

Top Treatment	Legend			
Medium Cassette				
3" Fascia				
Large Cassette				
Square Cassette				
Fabric Cornice				
4" Fascia				
Open Roll				

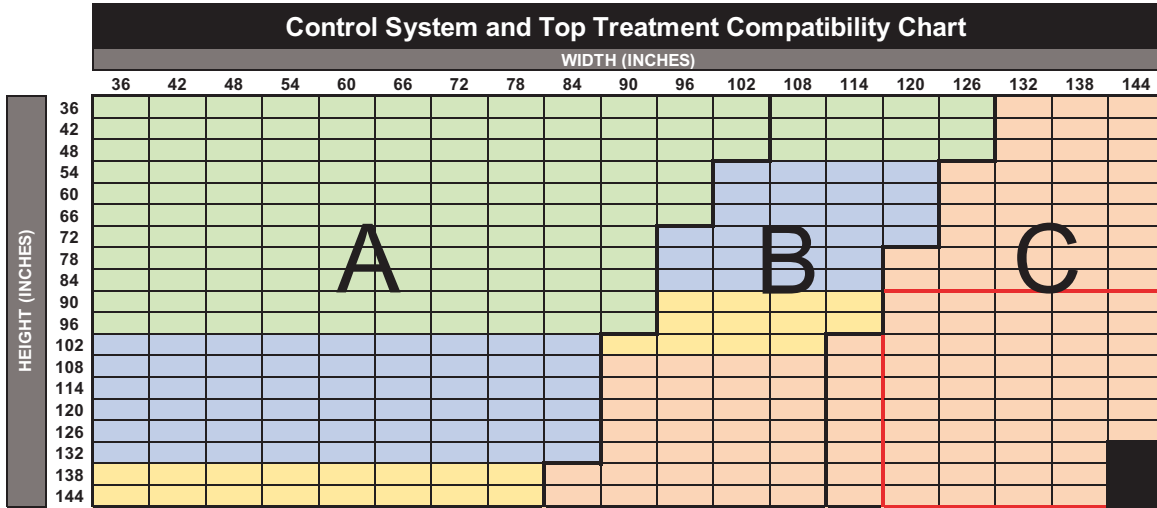

Control Systems (Minimum height for all Control Systems is 12")		Minimum Width (Single Panel)	Overall Minimum Width (2-on-1)	Specification Zone(s)*	Top Treatment
Continuous Loop Control	Continuous Loop Control (Maximum height for 12" width is 60")	12"	24"	A, B & C	All
	**Continuous Loop Control with Spring Assist	60"	NA	A, B & C	Open Roll & 4" Fascia
PowerWand	Powerwand 1.0 Li-Ion	21"	43"	A	All (except 3" Fascia)
	Powerwand 2.0 Li-Ion	22"	45"	A & B	
Lithium-ion Motors	Bliss™ 1.1 Li-Ion	21 1/2"	44"	A	All
	Bliss™ 2.0 Li-Ion	29"	59"	A & B	
	Sonessé® 28 WireFree™ RTS Li-Ion / Sonessé® 28 WireFree™ Zigbee Li-Ion	24 1/2"	50"	A	
	Sonessé® ULTRA 30 WireFree™ RTS Li-Ion	28 1/2"	58"	A & B	
DC Motors	Bliss™ 1.1 DC	16 1/2"	34"	A	All
	Bliss™ 2.0 DC	22 1/2"	46"	A & B	
	Sonessé® 28 WireFree™ RTS DC / Sonessé® 28 WireFree™ Zigbee DC	16 1/2"	34"	A	
	Sonessé® 30 RTS 24v DC	21"	NA	A & B	

**See Spring Assist Section in reference guide for details

*Not all fabrics are available in all zones

Control System and Top Treatment Compatibility Chart - High Torque Motors

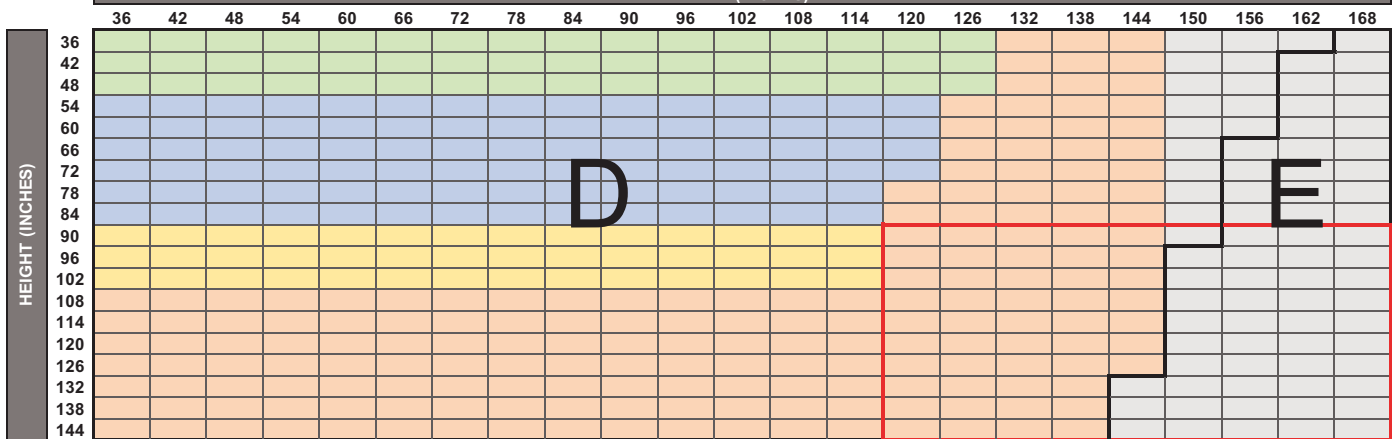

Control Systems (Minimum height for all Control Systems is 12")		Minimum Width (Single Panel)	Overall Minimum Width (2-on-1)	Specification Zone(s)*	Top Treatment
Lithium-ion Motors	Bliss™ 3.0 Li-Ion	32"	65"	D & E	All
	Sonessé® 40 WireFree™ RTS Li-Ion	31"	63"	D	
AC Motors	Bliss™ 10.0 AC	35"	NA	D & E	Open Roll, Fabric Cornice, and 4" Fascia
	Sonessé® 50 RTS AC (120V)	33"	NA	D & E	
	Sonessé® Ultra 50 AC (120V)	39"	NA	D & E	

*Not all fabrics are available in all zones

PRODUCT SIZE SPECIFICATIONS – CONTINUOUS LOOP CONTROL & AUTOMATION

Collection Code	Collection Name	Max Width Non-Railroaded ** (inches)	Max Width Railroaded (inches)	Available with Seam
AB018	Juniper Blackout	110	168	Yes

**To determine the maximum width for continuous Fabric Cornices, subtract 4 inches from the maximum non-railroad width.

- Railroad Fabrics (turned width for length) will have a visible seam when fabricated longer than the maximum roll width less 16".
- Red Box in spec chart indicates shade sizes Heat Sealed Hem Bar is recommended. For Continuous Loop Control, metal chain is also recommended for these sizes.

Top Treatment	Legend			
Medium Cassette				
3" Fascia				
Large Cassette				
Square Cassette				
Fabric Cornice				
4" Fascia				
Open Roll				

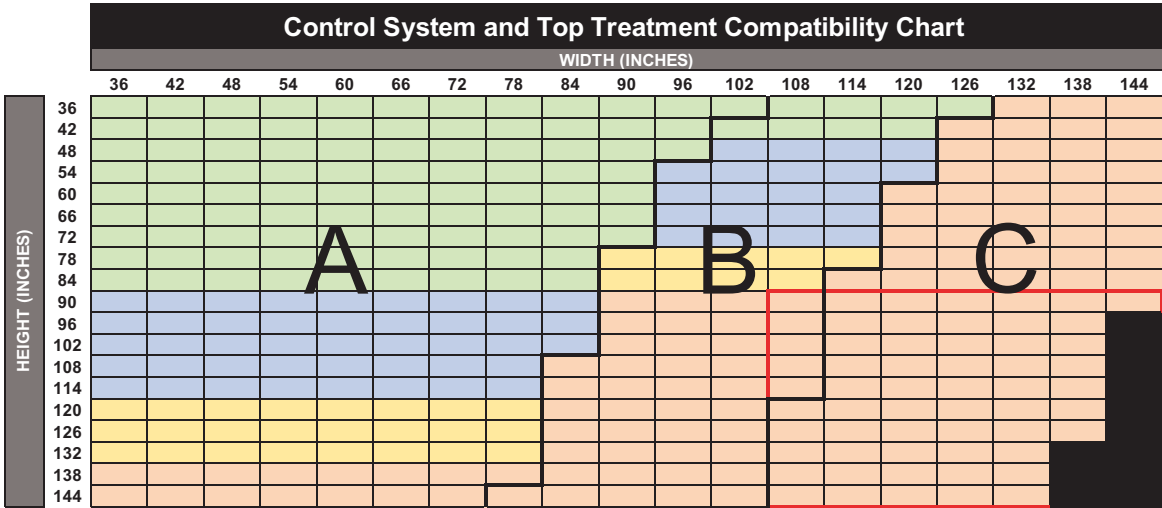

Control Systems (Minimum height for all Control Systems is 12")		Minimum Width (Single Panel)	Overall Minimum Width (2-on-1)	Specification Zone(s)*	Top Treatment
Continuous Loop Control	Continuous Loop Control (Maximum height for 12" width is 60")	12"	24"	A, B & C	All
	**Continuous Loop Control with Spring Assist	60"	NA	A, B & C	Open Roll & 4" Fascia
PowerWand	Powerwand 1.0 Li-Ion	21"	43"	A	All
	Powerwand 2.0 Li-Ion	22"	45"	A & B	(except 3" Fascia)
Lithium-ion Motors	Bliss™ 1.1 Li-Ion	21 1/2"	44"	A	All
	Bliss™ 2.0 Li-Ion	29"	59"	A & B	
	Sonesse® 28 WireFree™ RTS Li-Ion / Sonesse® 28 WireFree™ Zigbee Li-Ion	24 1/2"	50"	A	
	Sonesse® ULTRA 30 WireFree™ RTS Li-Ion	28 1/2"	58"	A & B	
DC Motors	Bliss™ 1.1 DC	16 1/2"	34"	A	All
	Bliss™ 2.0 DC	22 1/2"	46"	A & B	
	Sonesse® 28 WireFree™ RTS DC / Sonesse® 28 WireFree™ Zigbee DC	16 1/2"	34"	A	
	Sonesse® 30 RTS 24v DC	21"	NA	A & B	

**See Spring Assist Section in reference guide for details

*Not all fabrics are available in all zones

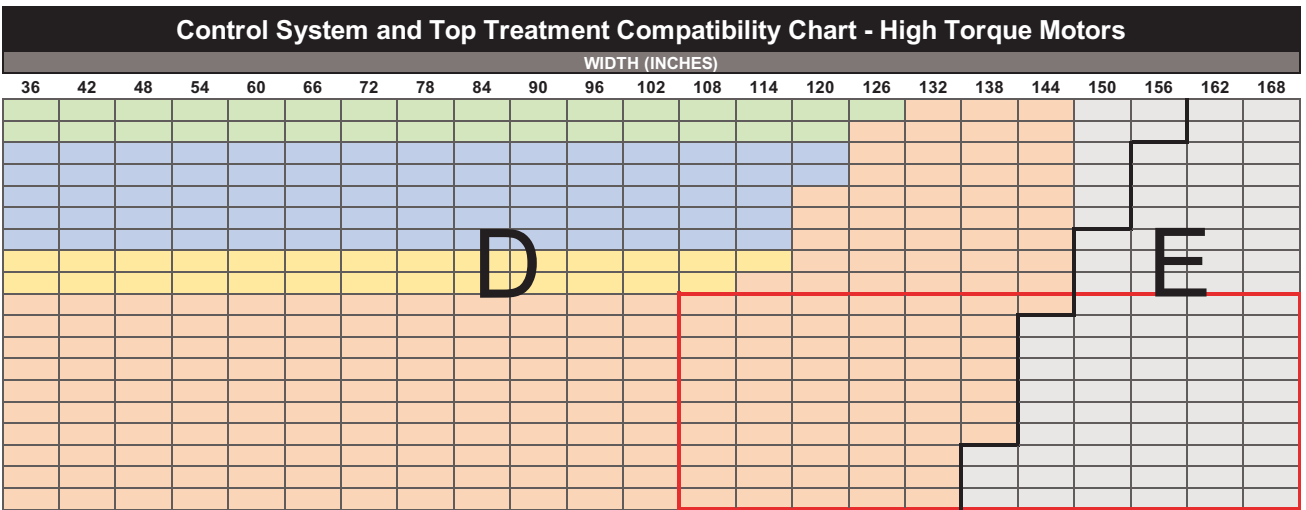

Control Systems (Minimum height for all Control Systems is 12")		Minimum Width (Single Panel)	Overall Minimum Width (2-on-1)	Specification Zone(s)*	Top Treatment
Lithium-ion Motors	Bliss™ 3.0 Li-Ion	32"	65"	D & E	All
	Sonesse® 40 WireFree™ RTS Li-Ion	31"	63"	D	
AC Motors	Bliss™ 10.0 AC	35"	NA	D & E	Open Roll, Fabric Cornice, and 4" Fascia
	Sonesse® 50 RTS AC (120V)	33"	NA	D & E	
	Sonesse® Ultra 50 AC (120V)	39"	NA	D & E	

*Not all fabrics are available in all zones

PRODUCT SIZE SPECIFICATIONS – CONTINUOUS LOOP CONTROL & AUTOMATION

Collection Code	Collection Name	Max Width Non-Railroaded ** (inches)	Max Width Railroaded (inches)	Available with Seam
AF033	Lavish	110	NA	No

**To determine the maximum width for continuous Fabric Cornices, subtract 4 inches from the maximum non-railroad width.

- Railroad Fabrics (turned width for length) will have a visible seam when fabricated longer than the maximum roll width less 16".
- Red Box in spec chart indicates shade sizes Heat Sealed Hem Bar is recommended. For Continuous Loop Control, metal chain is also recommended for these sizes.

Top Treatment	Legend			
Medium Cassette				
3" Fascia				
Large Cassette				
Square Cassette				
Fabric Cornice				
4" Fascia				
Open Roll				

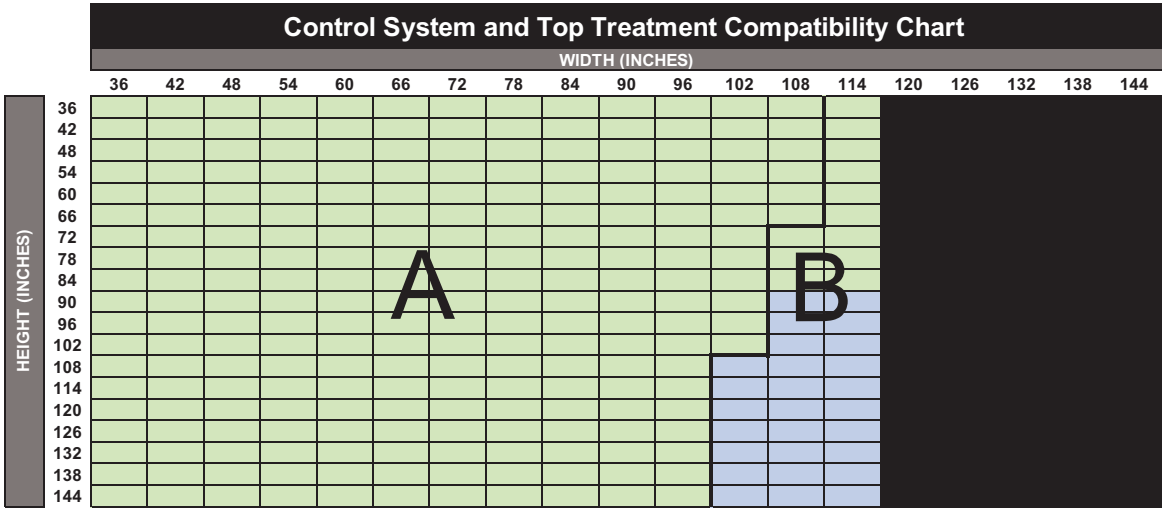

Control Systems (Minimum height for all Control Systems is 12")		Minimum Width (Single Panel)	Overall Minimum Width (2-on-1)	Specification Zone(s)*	Top Treatment
Continuous Loop Control	Continuous Loop Control (Maximum height for 12" width is 60")	12"	24"	A, B & C	All
	**Continuous Loop Control with Spring Assist	60"	NA	A, B & C	Open Roll & 4" Fascia
PowerWand	Powerwand 1.0 Li-Ion	21"	43"	A	All
	Powerwand 2.0 Li-Ion	22"	45"	A & B	(except 3" Fascia)
Lithium-ion Motors	Bliss™ 1.1 Li-Ion	21 1/2"	44"	A	All
	Bliss™ 2.0 Li-Ion	29"	59"	A & B	
	Sonessé® 28 WireFree™ RTS Li-Ion / Sonessé® 28 WireFree™ Zigbee Li-Ion	24 1/2"	50"	A	
	Sonessé® ULTRA 30 WireFree™ RTS Li-Ion	28 1/2"	58"	A & B	
DC Motors	Bliss™ 1.1 DC	16 1/2"	34"	A	All
	Bliss™ 2.0 DC	22 1/2"	46"	A & B	
	Sonessé® 28 WireFree™ RTS DC / Sonessé® 28 WireFree™ Zigbee DC	16 1/2"	34"	A	
	Sonessé® 30 RTS 24v DC	21"	NA	A & B	

**See Spring Assist Section in reference guide for details

*Not all fabrics are available in all zones

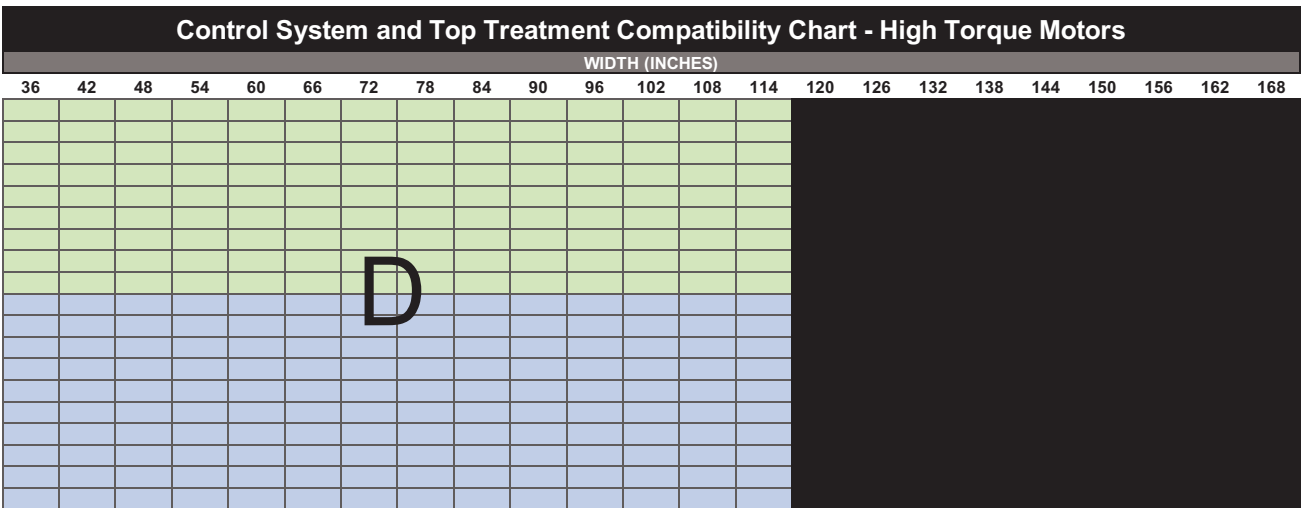

Control Systems (Minimum height for all Control Systems is 12")		Minimum Width (Single Panel)	Overall Minimum Width (2-on-1)	Specification Zone(s)*	Top Treatment
Lithium-ion Motors	Bliss™ 3.0 Li-Ion	32"	65"	D & E	All
	Sonessé® 40 WireFree™ RTS Li-Ion	31"	63"	D	
AC Motors	Bliss™ 10.0 AC	35"	NA	D & E	Open Roll, Fabric Cornice, and 4" Fascia
	Sonessé® 50 RTS AC (120V)	33"	NA	D & E	
	Sonessé® Ultra 50 AC (120V)	39"	NA	D & E	

*Not all fabrics are available in all zones

PRODUCT SIZE SPECIFICATIONS – CONTINUOUS LOOP CONTROL & AUTOMATION

Collection Code	Collection Name	Max Width Non-Railroaded ** (inches)	Max Width Railroaded (inches)	Available with Seam
R56	Linview	122	168	Yes
AF028	Bamboo	113	NA	No
AF027	Lady Amherst	113	NA	No

**To determine the maximum width for continuous Fabric Cornices, subtract 4 inches from the maximum non-railroad width.

• Railroad Fabrics (turned width for length) will have a visible seam when fabricated longer than the maximum roll width less 16".

• Red Box in spec chart indicates shade sizes Heat Sealed Hem Bar is recommended. For Continuous Loop Control, metal chain is also recommended for these sizes.

Top Treatment	Legend			
Medium Cassette				
3" Fascia				
Large Cassette				
Square Cassette				
Fabric Cornice				
4" Fascia				
Open Roll				

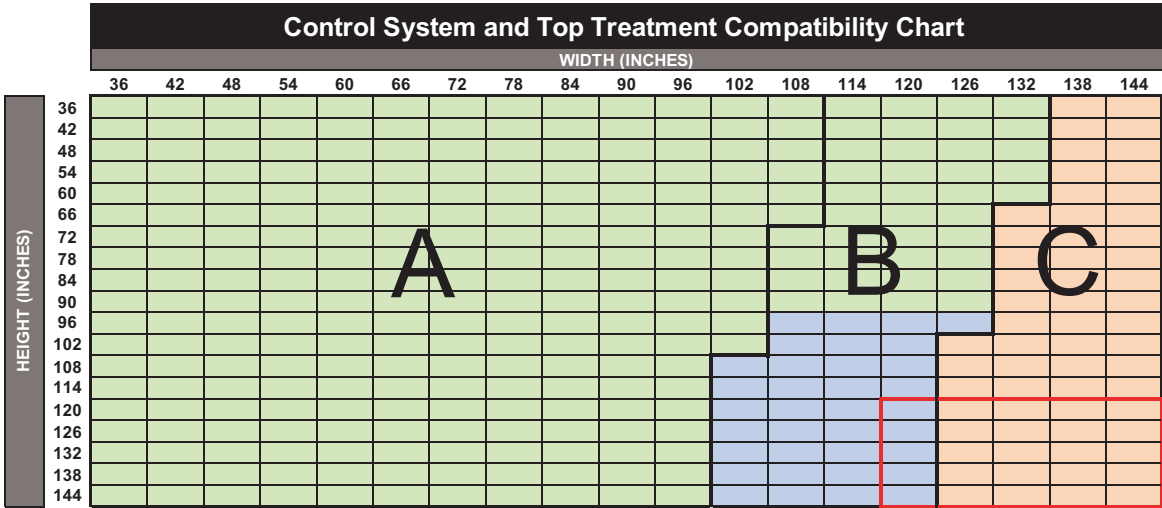

Control Systems (Minimum height for all Control Systems is 12")		Minimum Width (Single Panel)	Overall Minimum Width (2-on-1)	Specification Zone(s)*	Top Treatment
Continuous Loop Control	Continuous Loop Control (Maximum height for 12" width is 60")	12"	24"	A, B & C	All
	**Continuous Loop Control with Spring Assist	60"	NA	A, B & C	Open Roll & 4" Fascia
PowerWand	Powerwand 1.0 Li-Ion	21"	43"	A	All
	Powerwand 2.0 Li-Ion	22"	45"	A & B	(except 3" Fascia)
Lithium-ion Motors	Bliss™ 1.1 Li-Ion	21 1/2"	44"	A	All
	Bliss™ 2.0 Li-Ion	29"	59"	A & B	
	Sonessé® 28 WireFree™ RTS Li-Ion / Sonessé® 28 WireFree™ Zigbee Li-Ion	24 1/2"	50"	A	
	Sonessé® ULTRA 30 WireFree™ RTS Li-Ion	28 1/2"	58"	A & B	
DC Motors	Bliss™ 1.1 DC	16 1/2"	34"	A	All
	Bliss™ 2.0 DC	22 1/2"	46"	A & B	
	Sonessé® 28 WireFree™ RTS DC / Sonessé® 28 WireFree™ Zigbee DC	16 1/2"	34"	A	
	Sonessé® 30 RTS 24v DC	21"	NA	A & B	

**See Spring Assist Section in reference guide for details

*Not all fabrics are available in all zones

Control System and Top Treatment Compatibility Chart - High Torque Motors

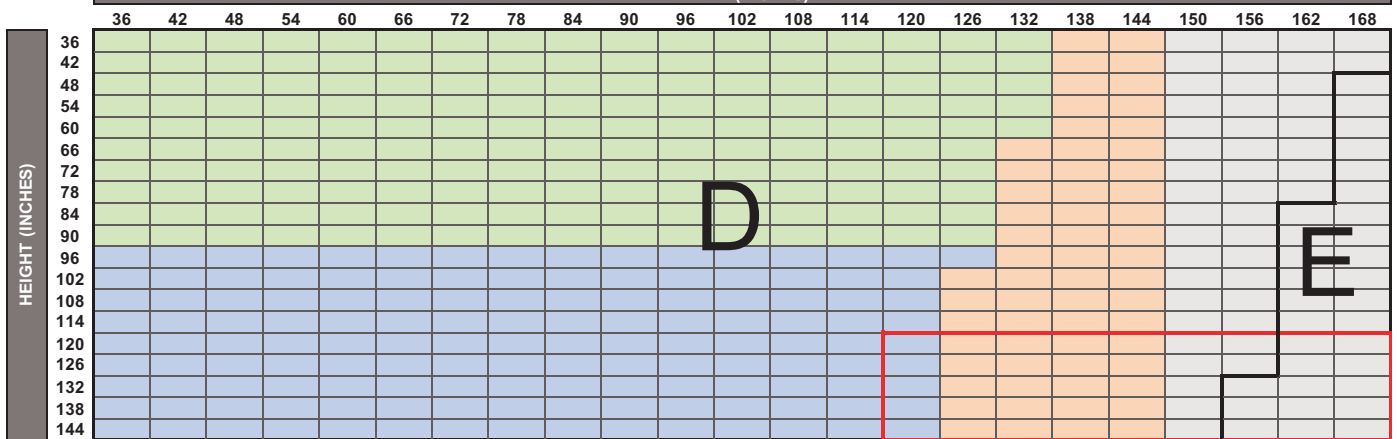

Control Systems (Minimum height for all Control Systems is 12")		Minimum Width (Single Panel)	Overall Minimum Width (2-on-1)	Specification Zone(s)*	Top Treatment
Lithium-ion Motors	Bliss™ 3.0 Li-Ion	32"	65"	D & E	All
	Sonessé® 40 WireFree™ RTS Li-Ion	31"	63"	D	
AC Motors	Bliss™ 10.0 AC	35"	NA	D & E	Open Roll, Fabric Cornice, and 4" Fascia
	Sonessé® 50 RTS AC (120V)	33"	NA	D & E	
	Sonessé® Ultra 50 AC (120V)	39"	NA	D & E	

*Not all fabrics are available in all zones

PRODUCT SIZE SPECIFICATIONS – CONTINUOUS LOOP CONTROL & AUTOMATION

Collection Code	Collection Name	Max Width Non-Railroaded ** (inches)	Max Width Railroaded (inches)	Available with Seam
RB3	Linview Blackout	120	168	Yes
AB028	Bamboo Blackout	113	NA	No
AB027	Lady Amherst Blackout	113	NA	No

Top Treatment	Legend			
Medium Cassette				
3" Fascia				
Large Cassette				
Square Cassette				
Fabric Cornice				
4" Fascia				
Open Roll				

**To determine the maximum width for continuous Fabric Cornices, subtract 4 inches from the maximum non-railroad width.

• Railroad Fabrics (turned width for length) will have a visible seam when fabricated longer than the maximum roll width less 16".

• Red Box in spec chart indicates shade sizes Heat Sealed Hem Bar is recommended. For Continuous Loop Control, metal chain is also recommended for these sizes.

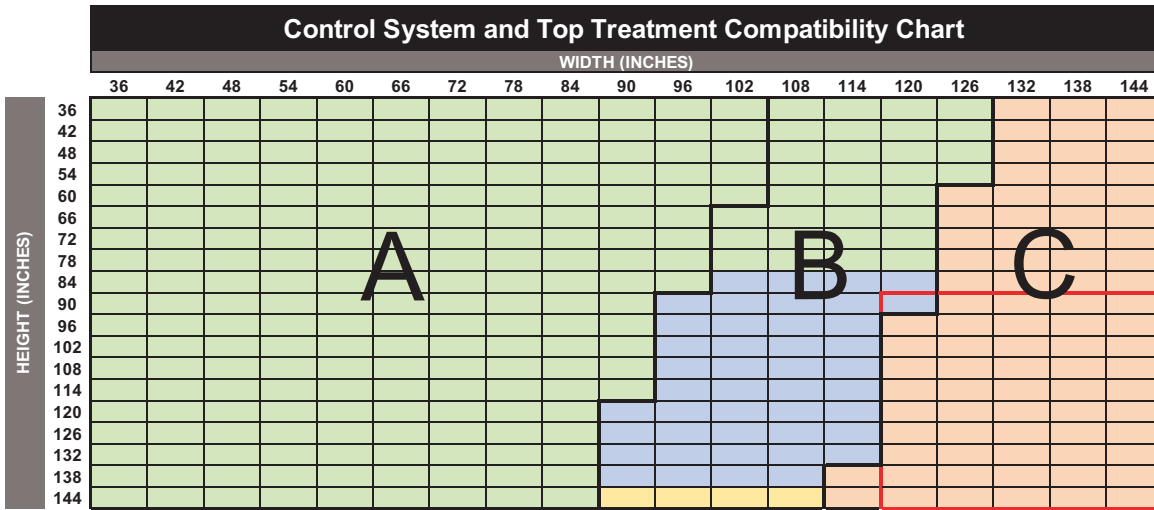

Control Systems (Minimum height for all Control Systems is 12")		Minimum Width (Single Panel)	Overall Minimum Width (2-on-1)	Specification Zone(s)*	Top Treatment
Continuous Loop Control	Continuous Loop Control (Maximum height for 12" width is 60")	12"	24"	A, B & C	All
	**Continuous Loop Control with Spring Assist	60"	NA	A, B & C	Open Roll & 4" Fascia
PowerWand	Powerwand 1.0 Li-Ion	21"	43"	A	All
	Powerwand 2.0 Li-Ion	22"	45"	A & B	(except 3" Fascia)
Lithium-ion Motors	Bliss™ 1.1 Li-Ion	21 1/2"	44"	A	All
	Bliss™ 2.0 Li-Ion	29"	59"	A & B	
	Sonesse® 28 WireFree™ RTS Li-Ion / Sonesse® 28 WireFree™ Zigbee Li-Ion	24 1/2"	50"	A	
	Sonesse® ULTRA 30 WireFree™ RTS Li-Ion	28 1/2"	58"	A & B	
DC Motors	Bliss™ 1.1 DC	16 1/2"	34"	A	All
	Bliss™ 2.0 DC	22 1/2"	46"	A & B	
	Sonesse® 28 WireFree™ RTS DC / Sonesse® 28 WireFree™ Zigbee DC	16 1/2"	34"	A	
	Sonesse® 30 RTS 24v DC	21"	NA	A & B	

**See Spring Assist Section in reference guide for details

*Not all fabrics are available in all zones

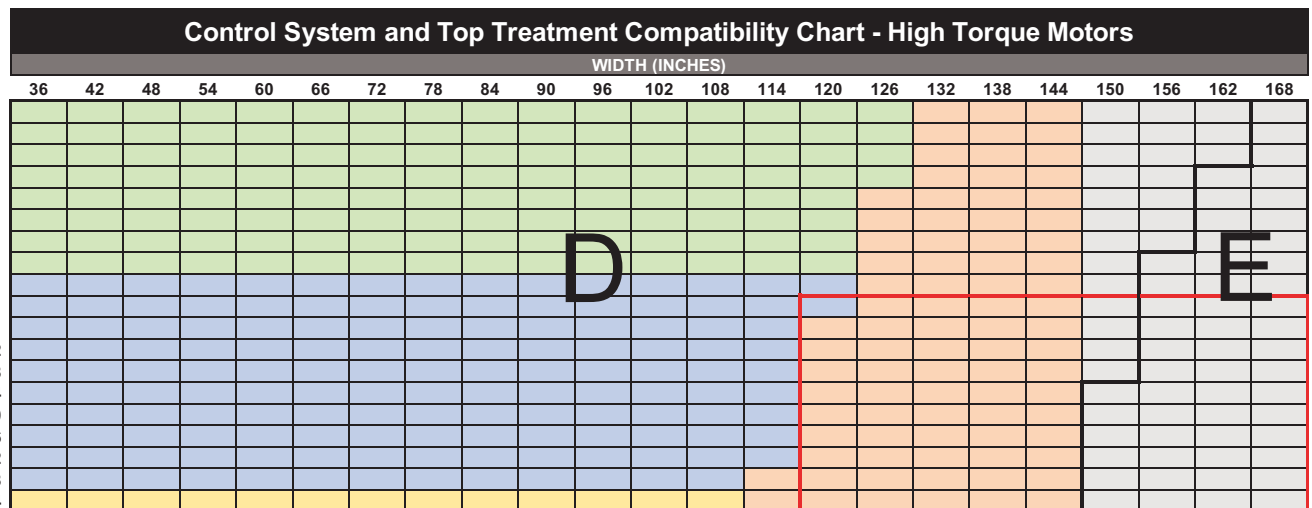

Control Systems (Minimum height for all Control Systems is 12")		Minimum Width (Single Panel)	Overall Minimum Width (2-on-1)	Specification Zone(s)*	Top Treatment
Lithium-ion Motors	Bliss™ 3.0 Li-Ion	32"	65"	D & E	All
	Sonesse® 40 WireFree™ RTS Li-Ion	31"	63"	D	
AC Motors	Bliss™ 10.0 AC	35"	NA	D & E	Open Roll, Fabric Cornice, and 4" Fascia
	Sonesse® 50 RTS AC (120V)	33"	NA	D & E	
	Sonesse® Ultra 50 AC (120V)	39"	NA	D & E	

*Not all fabrics are available in all zones

PRODUCT SIZE SPECIFICATIONS – CONTINUOUS LOOP CONTROL & AUTOMATION

Collection Code	Collection Name	Max Width Non-Railroaded ** (inches)	Max Width Railroaded (inches)	Available with Seam
RF4	Montero	94	NA	No

**To determine the maximum width for continuous Fabric Cornices, subtract 4 inches from the maximum non-railroad width.

- Railroad Fabrics (turned width for length) will have a visible seam when fabricated longer than the maximum roll width less 16".
- Red Box in spec chart indicates shade sizes Heat Sealed Hem Bar is recommended. For Continuous Loop Control, metal chain is also recommended for these sizes.

Top Treatment	Legend			
Medium Cassette				
3" Fascia				
Large Cassette				
Square Cassette				
Fabric Cornice				
4" Fascia				
Open Roll				

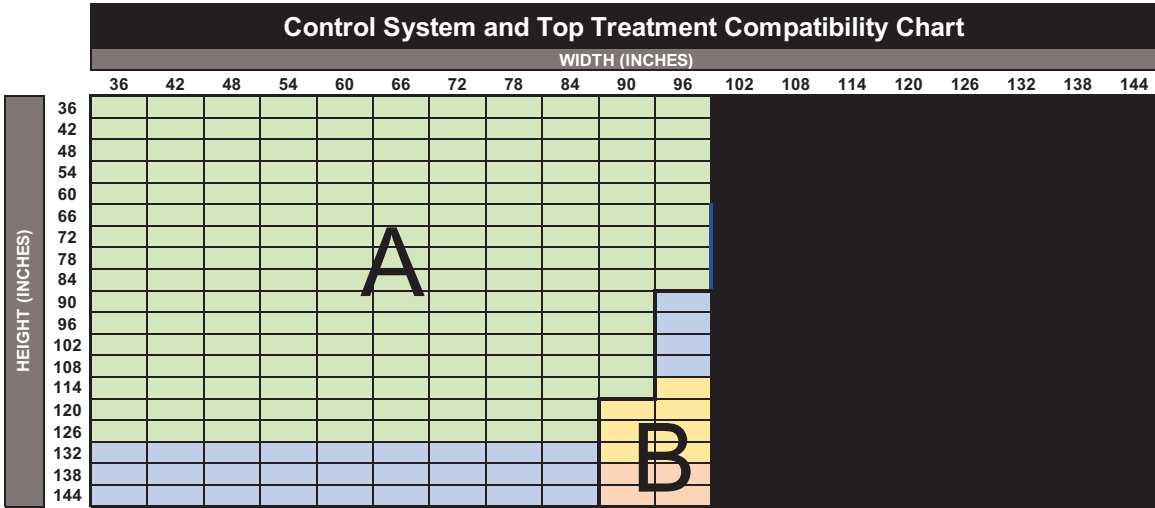

Control Systems (Minimum height for all Control Systems is 12")		Minimum Width (Single Panel)	Overall Minimum Width (2-on-1)	Specification Zone(s)*	Top Treatment
Continuous Loop Control	Continuous Loop Control (Maximum height for 12" width is 60")	12"	24"	A, B & C	All
	**Continuous Loop Control with Spring Assist	60"	NA	A, B & C	Open Roll & 4" Fascia
PowerWand	Powerwand 1.0 Li-Ion	21"	43"	A	All
	Powerwand 2.0 Li-Ion	22"	45"	A & B	(except 3" Fascia)
Lithium-ion Motors	Bliss™ 1.1 Li-Ion	21 1/2"	44"	A	All
	Bliss™ 2.0 Li-Ion	29"	59"	A & B	
	Sonessé® 28 WireFree™ RTS Li-Ion / Sonessé® 28 WireFree™ Zigbee Li-Ion	24 1/2"	50"	A	
	Sonessé® ULTRA 30 WireFree™ RTS Li-Ion	28 1/2"	58"	A & B	
DC Motors	Bliss™ 1.1 DC	16 1/2"	34"	A	All
	Bliss™ 2.0 DC	22 1/2"	46"	A & B	
	Sonessé® 28 WireFree™ RTS DC / Sonessé® 28 WireFree™ Zigbee DC	16 1/2"	34"	A	
	Sonessé® 30 RTS 24v DC	21"	NA	A & B	

**See Spring Assist Section in reference guide for details

*Not all fabrics are available in all zones

Control System and Top Treatment Compatibility Chart - High Torque Motors

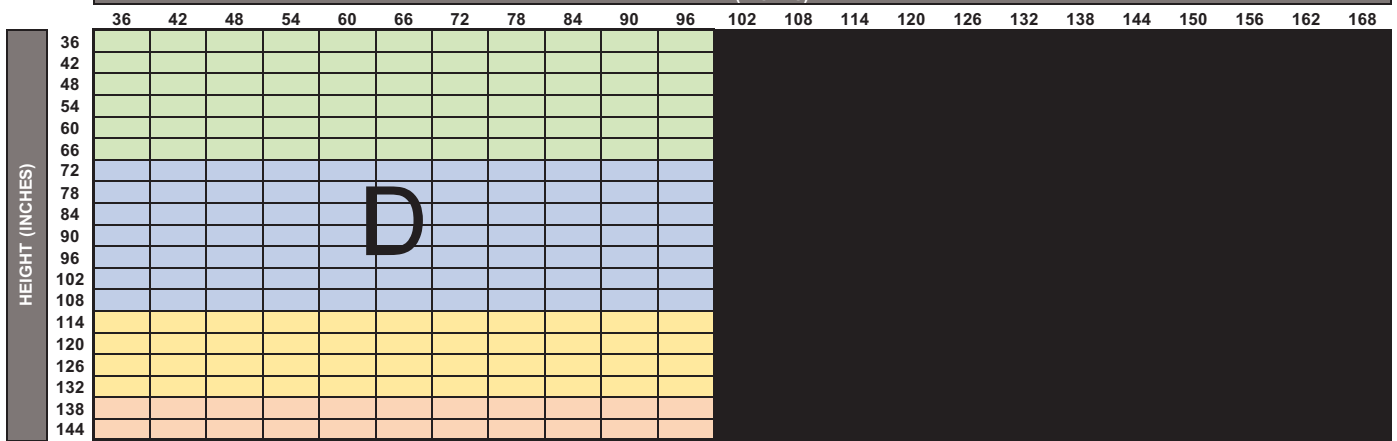

Control Systems (Minimum height for all Control Systems is 12")		Minimum Width (Single Panel)	Overall Minimum Width (2-on-1)	Specification Zone(s)*	Top Treatment
Lithium-ion Motors	Bliss™ 3.0 Li-Ion	32"	65"	D & E	All
	Sonessé® 40 WireFree™ RTS Li-Ion	31"	63"	D	
AC Motors	Bliss™ 10.0 AC	35"	NA	D & E	Open Roll, Fabric Cornice, and 4" Fascia
	Sonessé® 50 RTS AC (120V)	33"	NA	D & E	
	Sonessé® Ultra 50 AC (120V)	39"	NA	D & E	

*Not all fabrics are available in all zones

PRODUCT SIZE SPECIFICATIONS – CONTINUOUS LOOP CONTROL & AUTOMATION

Collection Code	Collection Name	Max Width Non-Railroaded ** (inches)	Max Width Railroaded (inches)	Available with Seam
AR041	Opulence Room Darkening	78 3/4	NA	No

**To determine the maximum width for continuous Fabric Cornices, subtract 4 inches from the maximum non-railroad width.

- Railroad Fabrics (turned width for length) will have a visible seam when fabricated longer than the maximum roll width less 16".
- Red Box in spec chart indicates shade sizes Heat Sealed Hem Bar is recommended. For Continuous Loop Control, metal chain is also recommended for these sizes.

Top Treatment	Legend			
Medium Cassette				
3" Fascia				
Large Cassette				
Square Cassette				
Fabric Cornice				
4" Fascia				
Open Roll				

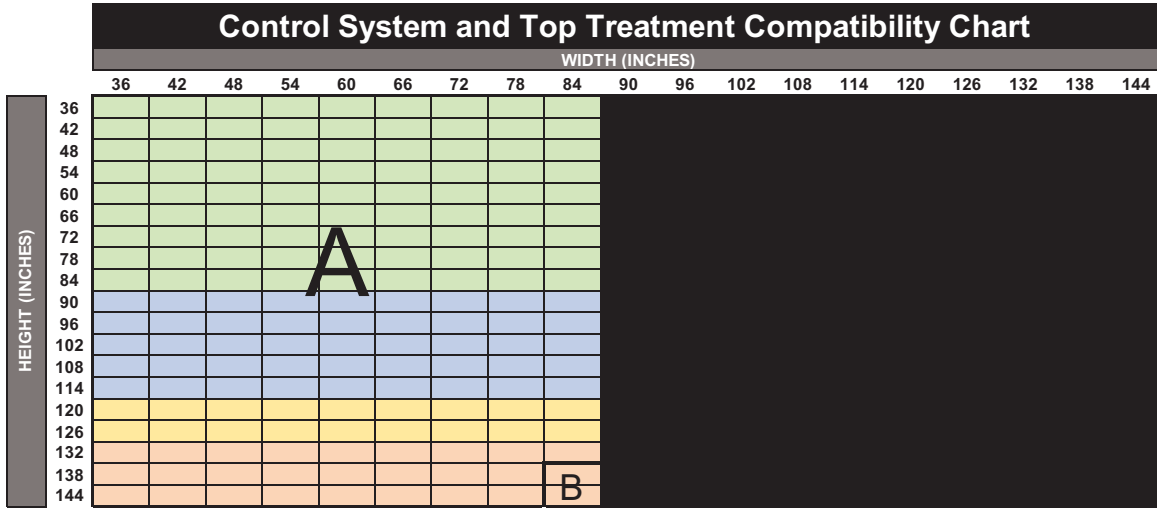

Control Systems (Minimum height for all Control Systems is 12")		Minimum Width (Single Panel)	Overall Minimum Width (2-on-1)	Specification Zone(s)*	Top Treatment
Continuous Loop Control	Continuous Loop Control (Maximum height for 12" width is 60")	12"	24"	A, B & C	All
	**Continuous Loop Control with Spring Assist	60"	NA	A, B & C	Open Roll & 4" Fascia
PowerWand	Powerwand 1.0 Li-Ion	21"	43"	A	All (except 3" Fascia)
	Powerwand 2.0 Li-Ion	22"	45"	A & B	
Lithium-ion Motors	Bliss™ 1.1 Li-Ion	21 1/2"	44"	A	All
	Bliss™ 2.0 Li-Ion	29"	59"	A & B	
	Sonessé® 28 WireFree™ RTS Li-Ion / Sonessé® 28 WireFree™ Zigbee Li-Ion	24 1/2"	50"	A	
	Sonessé® ULTRA 30 WireFree™ RTS Li-Ion	28 1/2"	58"	A & B	
DC Motors	Bliss™ 1.1 DC	16 1/2"	34"	A	All
	Bliss™ 2.0 DC	22 1/2"	46"	A & B	
	Sonessé® 28 WireFree™ RTS DC / Sonessé® 28 WireFree™ Zigbee DC	16 1/2"	34"	A	
	Sonessé® 30 RTS 24v DC	21"	NA	A & B	

**See Spring Assist Section in reference guide for details

*Not all fabrics are available in all zones

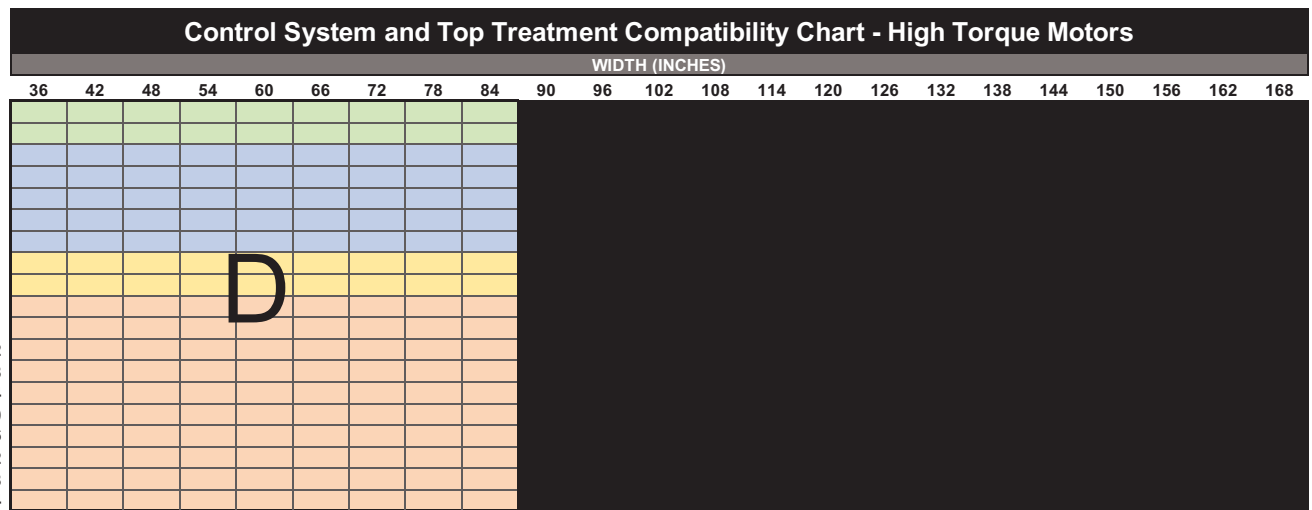

Control Systems (Minimum height for all Control Systems is 12")		Minimum Width (Single Panel)	Overall Minimum Width (2-on-1)	Specification Zone(s)*	Top Treatment
Lithium-ion Motors	Bliss™ 3.0 Li-Ion	32"	65"	D & E	All
	Sonessé® 40 WireFree™ RTS Li-Ion	31"	63"	D	
AC Motors	Bliss™ 10.0 AC	35"	NA	D & E	Open Roll, Fabric Cornice, and 4" Fascia
	Sonessé® 50 RTS AC (120V)	33"	NA	D & E	
	Sonessé® Ultra 50 AC (120V)	39"	NA	D & E	

*Not all fabrics are available in all zones

PRODUCT SIZE SPECIFICATIONS – CONTINUOUS LOOP CONTROL & AUTOMATION

Collection Code	Collection Name	Max Width Non-Railroaded ** (inches)	Max Width Railroaded (inches)	Available with Seam
AF032	Pacific	122	NA	No

**To determine the maximum width for continuous Fabric Cornices, subtract 4 inches from the maximum non-railroad width.

- Railroad Fabrics (turned width for length) will have a visible seam when fabricated longer than the maximum roll width less 16".
- Red Box in spec chart indicates shade sizes Heat Sealed Hem Bar is recommended. For Continuous Loop Control, metal chain is also recommended for these sizes.

Top Treatment	Legend			
Medium Cassette				
3" Fascia				
Large Cassette				
Square Cassette				
Fabric Cornice				
4" Fascia				
Open Roll				

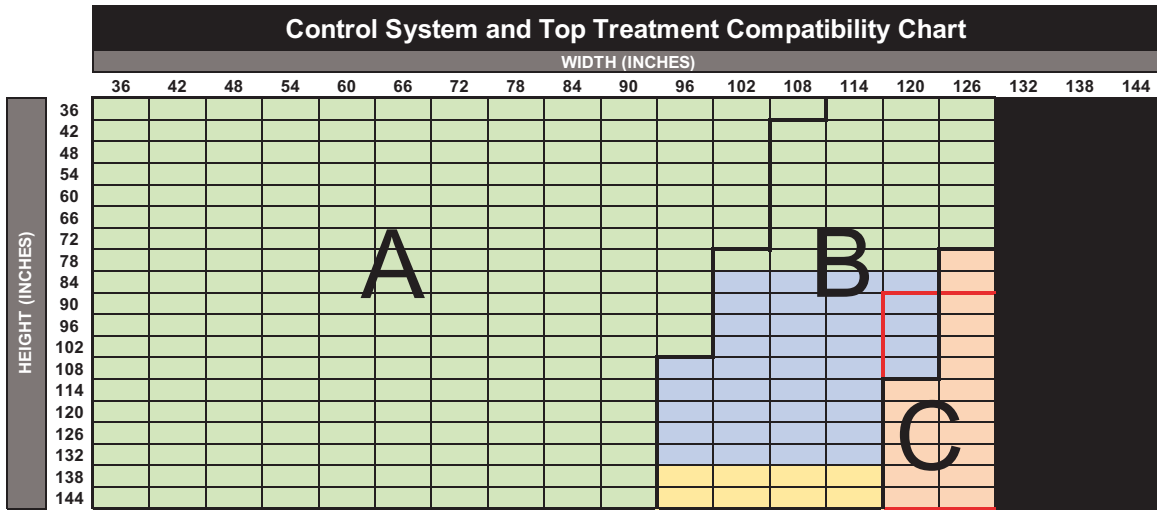

Control Systems (Minimum height for all Control Systems is 12")		Minimum Width (Single Panel)	Overall Minimum Width (2-on-1)	Specification Zone(s)*	Top Treatment
Continuous Loop Control	Continuous Loop Control (Maximum height for 12" width is 60")	12"	24"	A, B & C	All
	**Continuous Loop Control with Spring Assist	60"	NA	A, B & C	Open Roll & 4" Fascia
PowerWand	Powerwand 1.0 Li-Ion	21"	43"	A	All
	Powerwand 2.0 Li-Ion	22"	45"	A & B	(except 3" Fascia)
Lithium-ion Motors	Bliss™ 1.1 Li-Ion	21 1/2"	44"	A	All
	Bliss™ 2.0 Li-Ion	29"	59"	A & B	
	Sonessé® 28 WireFree™ RTS Li-Ion / Sonessé® 28 WireFree™ Zigbee Li-Ion	24 1/2"	50"	A	
	Sonessé® ULTRA 30 WireFree™ RTS Li-Ion	28 1/2"	58"	A & B	
DC Motors	Bliss™ 1.1 DC	16 1/2"	34"	A	All
	Bliss™ 2.0 DC	22 1/2"	46"	A & B	
	Sonessé® 28 WireFree™ RTS DC / Sonessé® 28 WireFree™ Zigbee DC	16 1/2"	34"	A	
	Sonessé® 30 RTS 24v DC	21"	NA	A & B	

**See Spring Assist Section in reference guide for details

*Not all fabrics are available in all zones

Control System and Top Treatment Compatibility Chart - High Torque Motors

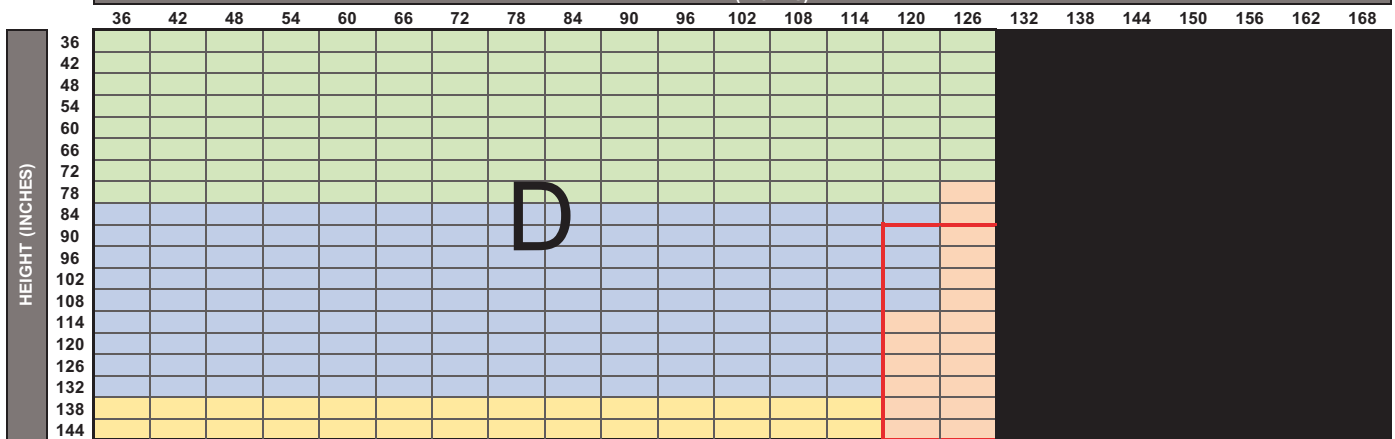

Control Systems (Minimum height for all Control Systems is 12")		Minimum Width (Single Panel)	Overall Minimum Width (2-on-1)	Specification Zone(s)*	Top Treatment
Lithium-ion Motors	Bliss™ 3.0 Li-Ion	32"	65"	D & E	All
	Sonessé® 40 WireFree™ RTS Li-Ion	31"	63"	D	
AC Motors	Bliss™ 10.0 AC	35"	NA	D & E	Open Roll, Fabric Cornice, and 4" Fascia
	Sonessé® 50 RTS AC (120V)	33"	NA	D & E	
	Sonessé® Ultra 50 AC (120V)	39"	NA	D & E	

*Not all fabrics are available in all zones

PRODUCT SIZE SPECIFICATIONS – CONTINUOUS LOOP CONTROL & AUTOMATION

Collection Code	Collection Name	Max Width Non-Railroaded ** (inches)	Max Width Railroaded (inches)	Available with Seam
AB032	Pacific Blackout	121	NA	No

**To determine the maximum width for continuous Fabric Cornices, subtract 4 inches from the maximum non-railroad width.

- Railroad Fabrics (turned width for length) will have a visible seam when fabricated longer than the maximum roll width less 16".
- Red Box in spec chart indicates shade sizes Heat Sealed Hem Bar is recommended. For Continuous Loop Control, metal chain is also recommended for these sizes.

Top Treatment	Legend			
Medium Cassette				
3" Fascia				
Large Cassette				
Square Cassette				
Fabric Cornice				
4" Fascia				
Open Roll				

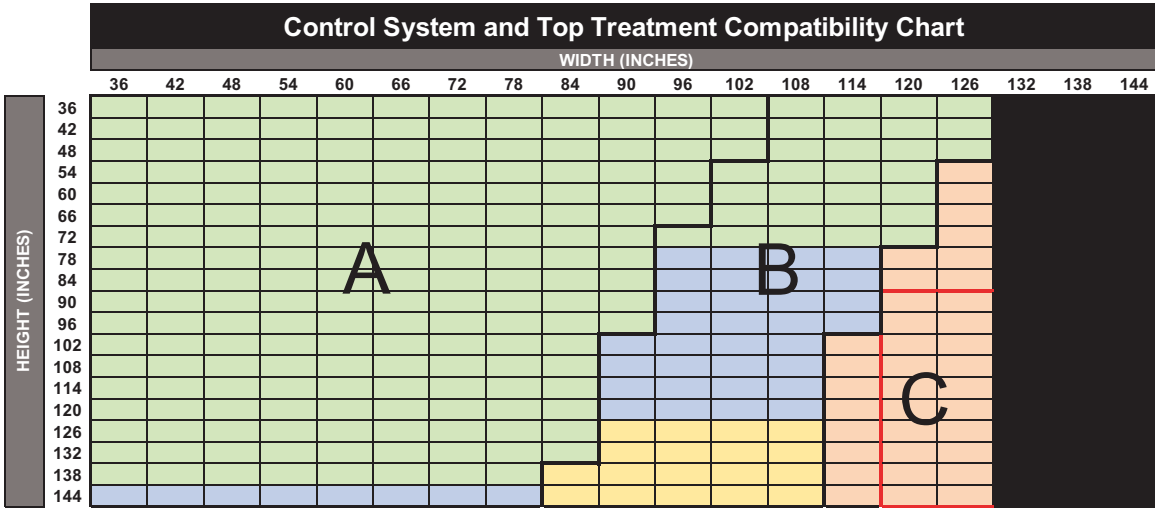

Control Systems (Minimum height for all Control Systems is 12")		Minimum Width (Single Panel)	Overall Minimum Width (2-on-1)	Specification Zone(s)*	Top Treatment
Continuous Loop Control	Continuous Loop Control (Maximum height for 12" width is 60")	12"	24"	A, B & C	All
	**Continuous Loop Control with Spring Assist	60"	NA	A, B & C	Open Roll & 4" Fascia
PowerWand	Powerwand 1.0 Li-Ion	21"	43"	A	All
	Powerwand 2.0 Li-Ion	22"	45"	A & B	(except 3" Fascia)
Lithium-ion Motors	Bliss™ 1.1 Li-Ion	21 1/2"	44"	A	All
	Bliss™ 2.0 Li-Ion	29"	59"	A & B	
	Sonesse® 28 WireFree™ RTS Li-Ion / Sonesse® 28 WireFree™ Zigbee Li-Ion	24 1/2"	50"	A	
	Sonesse® ULTRA 30 WireFree™ RTS Li-Ion	28 1/2"	58"	A & B	
DC Motors	Bliss™ 1.1 DC	16 1/2"	34"	A	All
	Bliss™ 2.0 DC	22 1/2"	46"	A & B	
	Sonesse® 28 WireFree™ RTS DC / Sonesse® 28 WireFree™ Zigbee DC	16 1/2"	34"	A	
	Sonesse® 30 RTS 24v DC	21"	NA	A & B	

**See Spring Assist Section in reference guide for details

*Not all fabrics are available in all zones

Control System and Top Treatment Compatibility Chart - High Torque Motors

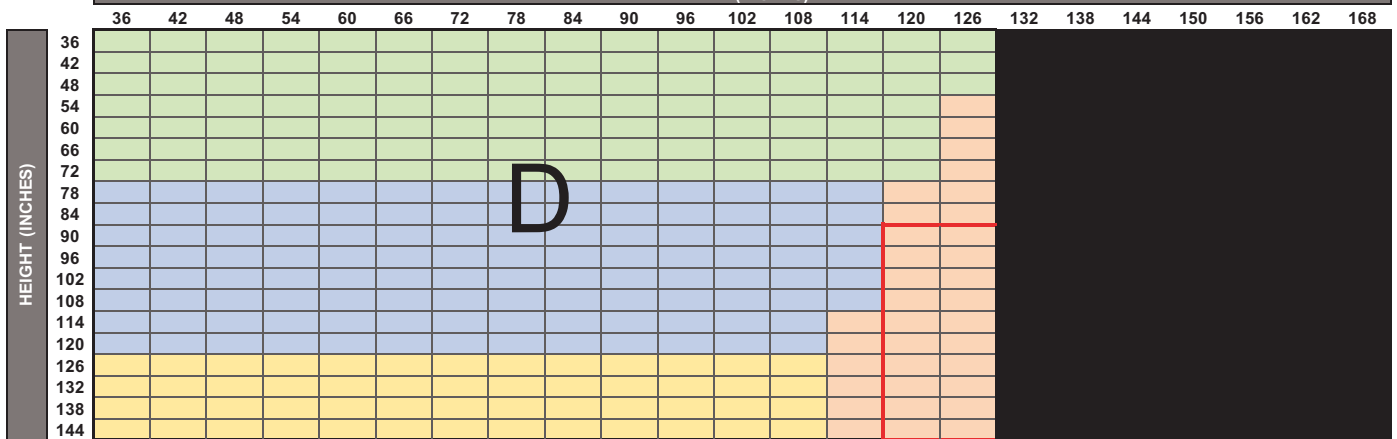

Control Systems (Minimum height for all Control Systems is 12")		Minimum Width (Single Panel)	Overall Minimum Width (2-on-1)	Specification Zone(s)*	Top Treatment
Lithium-ion Motors	Bliss™ 3.0 Li-Ion	32"	65"	D & E	All
	Sonesse® 40 WireFree™ RTS Li-Ion	31"	63"	D	
AC Motors	Bliss™ 10.0 AC	35"	NA	D & E	Open Roll, Fabric Cornice, and 4" Fascia
	Sonesse® 50 RTS AC (120V)	33"	NA	D & E	
	Sonesse® Ultra 50 AC (120V)	39"	NA	D & E	

*Not all fabrics are available in all zones

PRODUCT SIZE SPECIFICATIONS – CONTINUOUS LOOP CONTROL & AUTOMATION

Collection Code	Collection Name	Max Width Non-Railroaded ** (inches)	Max Width Railroaded (inches)	Available with Seam
AF017	Queenland	118	NA	No

**To determine the maximum width for continuous Fabric Cornices, subtract 4 inches from the maximum non-railroad width.

- Railroad Fabrics (turned width for length) will have a visible seam when fabricated longer than the maximum roll width less 16".
- Red Box in spec chart indicates shade sizes Heat Sealed Hem Bar is recommended. For Continuous Loop Control, metal chain is also recommended for these sizes.

Top Treatment	Legend			
Medium Cassette				
3" Fascia				
Large Cassette				
Square Cassette				
Fabric Cornice				
4" Fascia				
Open Roll				

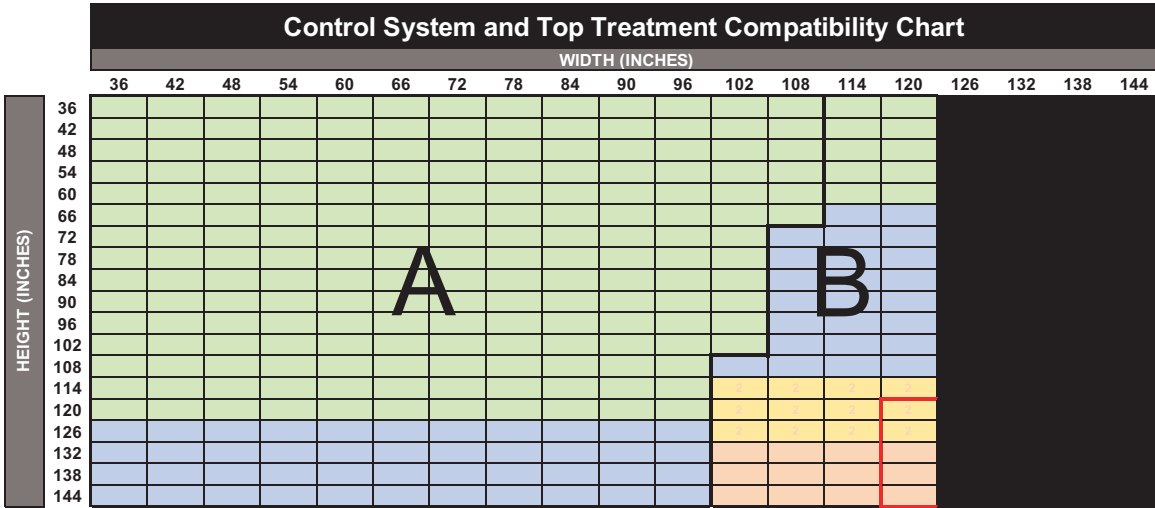

Control Systems (Minimum height for all Control Systems is 12")		Minimum Width (Single Panel)	Overall Minimum Width (2-on-1)	Specification Zone(s)*	Top Treatment
Continuous Loop Control	Continuous Loop Control (Maximum height for 12" width is 60")	12"	24"	A, B & C	All
	**Continuous Loop Control with Spring Assist	60"	NA	A, B & C	Open Roll & 4" Fascia
PowerWand	Powerwand 1.0 Li-Ion	21"	43"	A	All
	Powerwand 2.0 Li-Ion	22"	45"	A & B	(except 3" Fascia)
Lithium-ion Motors	Bliss™ 1.1 Li-Ion	21 1/2"	44"	A	All
	Bliss™ 2.0 Li-Ion	29"	59"	A & B	
	Sonessé® 28 WireFree™ RTS Li-Ion / Sonessé® 28 WireFree™ Zigbee Li-Ion	24 1/2"	50"	A	
	Sonessé® ULTRA 30 WireFree™ RTS Li-Ion	28 1/2"	58"	A & B	
DC Motors	Bliss™ 1.1 DC	16 1/2"	34"	A	All
	Bliss™ 2.0 DC	22 1/2"	46"	A & B	
	Sonessé® 28 WireFree™ RTS DC / Sonessé® 28 WireFree™ Zigbee DC	16 1/2"	34"	A	
	Sonessé® 30 RTS 24v DC	21"	NA	A & B	

**See Spring Assist Section in reference guide for details

*Not all fabrics are available in all zones

Control System and Top Treatment Compatibility Chart - High Torque Motors

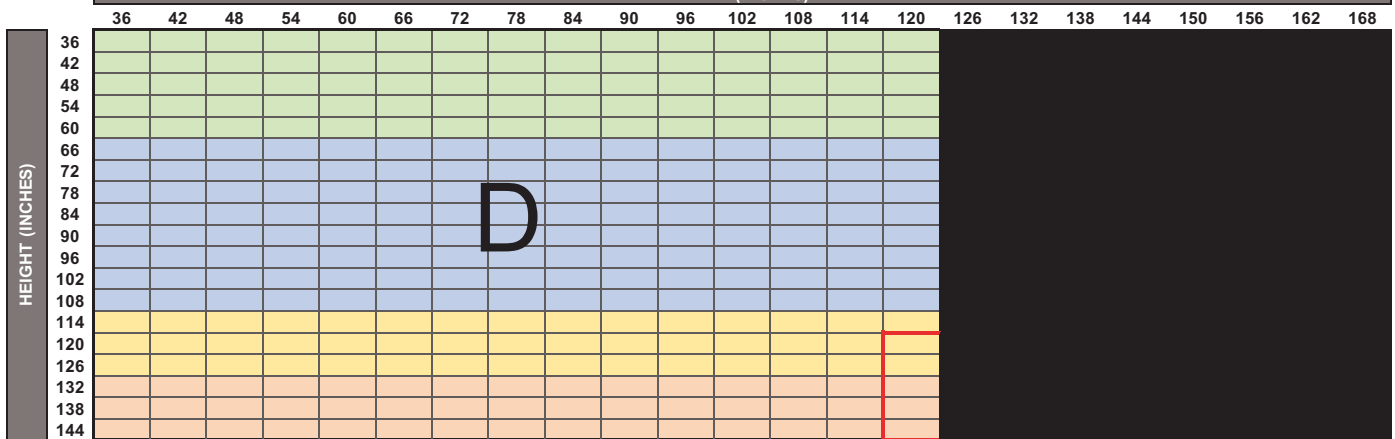

Control Systems (Minimum height for all Control Systems is 12")		Minimum Width (Single Panel)	Overall Minimum Width (2-on-1)	Specification Zone(s)*	Top Treatment
Lithium-ion Motors	Bliss™ 3.0 Li-Ion	32"	65"	D & E	All
	Sonessé® 40 WireFree™ RTS Li-Ion	31"	63"	D	
AC Motors	Bliss™ 10.0 AC	35"	NA	D & E	Open Roll, Fabric Cornice, and 4" Fascia
	Sonessé® 50 RTS AC (120V)	33"	NA	D & E	
	Sonessé® Ultra 50 AC (120V)	39"	NA	D & E	

*Not all fabrics are available in all zones

PRODUCT SIZE SPECIFICATIONS – CONTINUOUS LOOP CONTROL & AUTOMATION

Collection Code	Collection Name	Max Width Non-Railroaded ** (inches)	Max Width Railroaded (inches)	Available with Seam
AB017	Queensland Blackout	114	NA	No

**To determine the maximum width for continuous Fabric Cornices, subtract 4 inches from the maximum non-railroad width.

- Railroad Fabrics (turned width for length) will have a visible seam when fabricated longer than the maximum roll width less 16".
- Red Box in spec chart indicates shade sizes Heat Sealed Hem Bar is recommended. For Continuous Loop Control, metal chain is also recommended for these sizes.

Top Treatment	Legend				
Medium Cassette					
3" Fascia					
Large Cassette					
Square Cassette					
Fabric Cornice					
4" Fascia					
Open Roll					

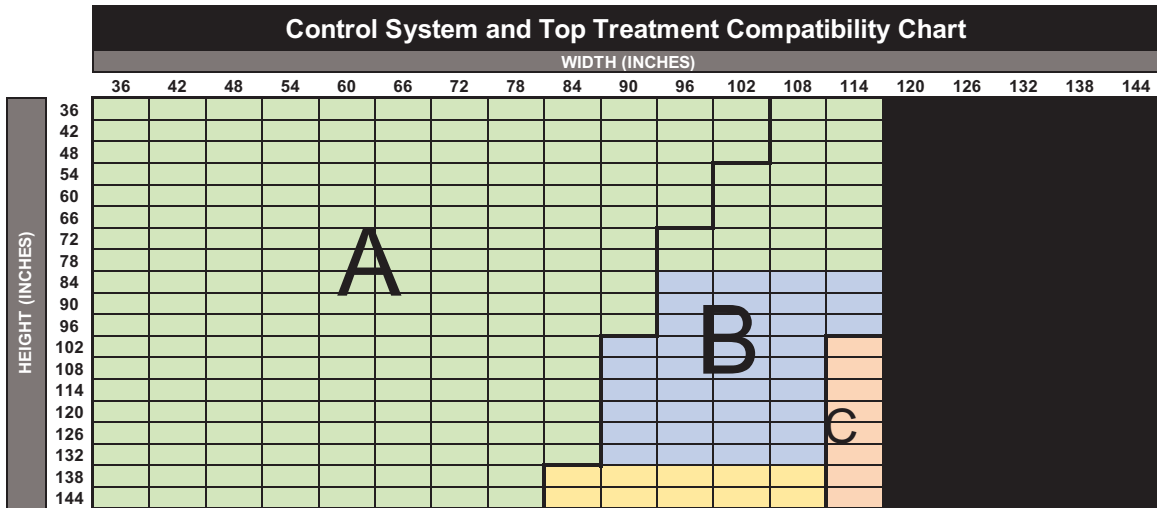

Control Systems (Minimum height for all Control Systems is 12")		Minimum Width (Single Panel)	Overall Minimum Width (2-on-1)	Specification Zone(s)*	Top Treatment
Continuous Loop Control	Continuous Loop Control (Maximum height for 12" width is 60")	12"	24"	A, B & C	All
	**Continuous Loop Control with Spring Assist	60"	NA	A, B & C	Open Roll & 4" Fascia
PowerWand	Powerwand 1.0 Li-Ion	21"	43"	A	All
	Powerwand 2.0 Li-Ion	22"	45"	A & B	(except 3" Fascia)
Lithium-ion Motors	Bliss™ 1.1 Li-Ion	21 1/2"	44"	A	All
	Bliss™ 2.0 Li-Ion	29"	59"	A & B	
	Sonessé® 28 WireFree™ RTS Li-Ion / Sonessé® 28 WireFree™ Zigbee Li-Ion	24 1/2"	50"	A	
	Sonessé® ULTRA 30 WireFree™ RTS Li-Ion	28 1/2"	58"	A & B	
DC Motors	Bliss™ 1.1 DC	16 1/2"	34"	A	All
	Bliss™ 2.0 DC	22 1/2"	46"	A & B	
	Sonessé® 28 WireFree™ RTS DC / Sonessé® 28 WireFree™ Zigbee DC	16 1/2"	34"	A	
	Sonessé® 30 RTS 24v DC	21"	NA	A & B	

**See Spring Assist Section in reference guide for details

*Not all fabrics are available in all zones

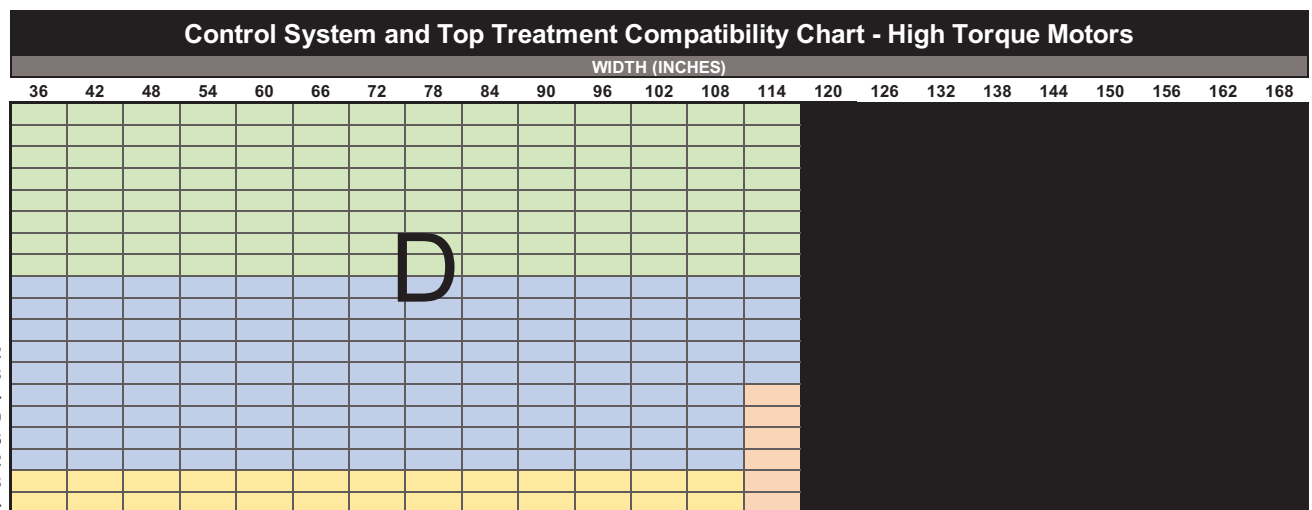

Control Systems (Minimum height for all Control Systems is 12")		Minimum Width (Single Panel)	Overall Minimum Width (2-on-1)	Specification Zone(s)*	Top Treatment
Lithium-ion Motors	Bliss™ 3.0 Li-Ion	32"	65"	D & E	All
	Sonessé® 40 WireFree™ RTS Li-Ion	31"	63"	D	
AC Motors	Bliss™ 10.0 AC	35"	NA	D & E	Open Roll, Fabric Cornice, and 4" Fascia
	Sonessé® 50 RTS AC (120V)	33"	NA	D & E	
	Sonessé® Ultra 50 AC (120V)	39"	NA	D & E	

*Not all fabrics are available in all zones

PRODUCT SIZE SPECIFICATIONS – CONTINUOUS LOOP CONTROL & AUTOMATION

Collection Code	Collection Name	Max Width Non-Railroaded ** (inches)	Max Width Railroaded (inches)	Available with Seam
RD21	Ranger	110	NA	No
AF026	Delhi	105	NA	No
AF025	Heritage	105	NA	No

**To determine the maximum width for continuous Fabric Cornices, subtract 4 inches from the maximum non-railroad width.

• Railroad Fabrics (turned width for length) will have a visible seam when fabricated longer than the maximum roll width less 16".

• Red Box in spec chart indicates shade sizes Heat Sealed Hem Bar is recommended. For Continuous Loop Control, metal chain is also recommended for these sizes.

Top Treatment	Legend			
Medium Cassette				
3" Fascia				
Large Cassette				
Square Cassette				
Fabric Cornice				
4" Fascia				
Open Roll				

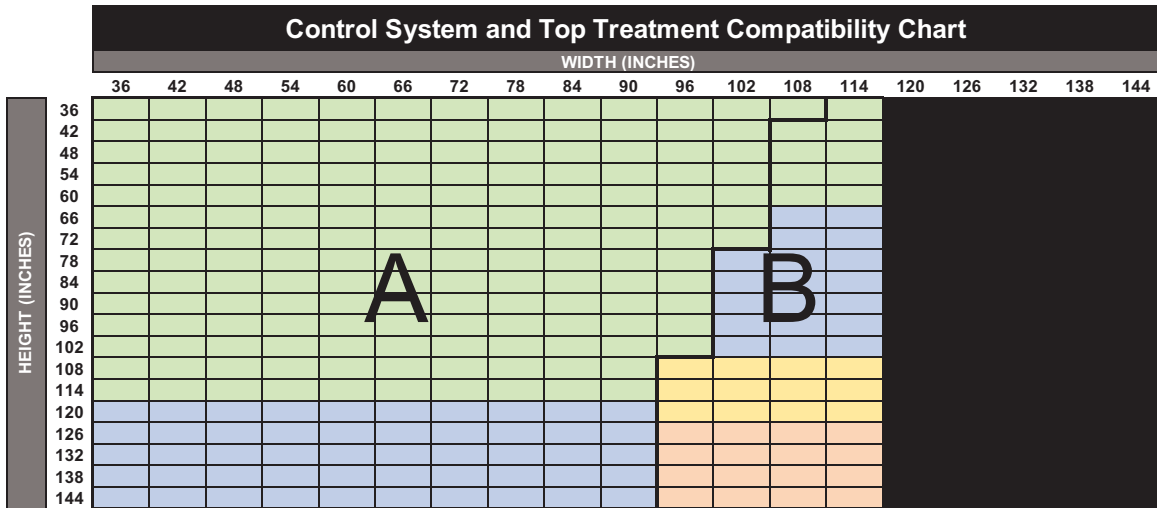

Control Systems (Minimum height for all Control Systems is 12")		Minimum Width (Single Panel)	Overall Minimum Width (2-on-1)	Specification Zone(s)*	Top Treatment
Continuous Loop Control	Continuous Loop Control (Maximum height for 12" width is 60")	12"	24"	A, B & C	All
	**Continuous Loop Control with Spring Assist	60"	NA	A, B & C	Open Roll & 4" Fascia
PowerWand	Powerwand 1.0 Li-Ion	21"	43"	A	All
	Powerwand 2.0 Li-Ion	22"	45"	A & B	(except 3" Fascia)
Lithium-ion Motors	Bliss™ 1.1 Li-Ion	21 1/2"	44"	A	All
	Bliss™ 2.0 Li-Ion	29"	59"	A & B	
	Sonessé® 28 WireFree™ RTS Li-Ion / Sonessé® 28 WireFree™ Zigbee Li-Ion	24 1/2"	50"	A	
	Sonessé® ULTRA 30 WireFree™ RTS Li-Ion	28 1/2"	58"	A & B	
DC Motors	Bliss™ 1.1 DC	16 1/2"	34"	A	All
	Bliss™ 2.0 DC	22 1/2"	46"	A & B	
	Sonessé® 28 WireFree™ RTS DC / Sonessé® 28 WireFree™ Zigbee DC	16 1/2"	34"	A	
	Sonessé® 30 RTS 24v DC	21"	NA	A & B	

**See Spring Assist Section in reference guide for details

*Not all fabrics are available in all zones

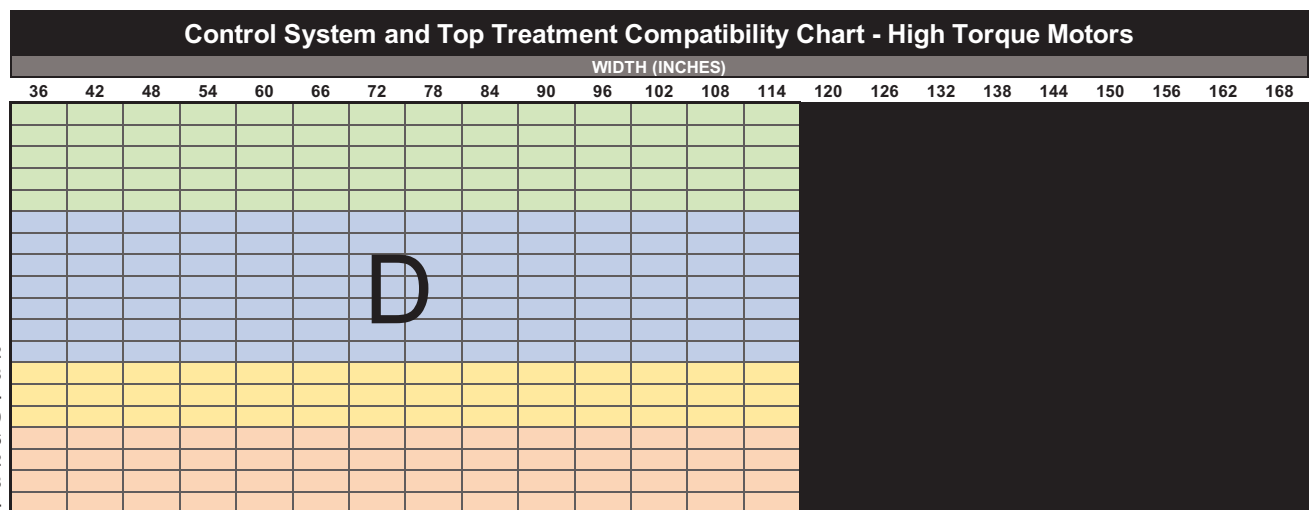

Control Systems (Minimum height for all Control Systems is 12")		Minimum Width (Single Panel)	Overall Minimum Width (2-on-1)	Specification Zone(s)*	Top Treatment
Lithium-ion Motors	Bliss™ 3.0 Li-Ion	32"	65"	D & E	All
	Sonessé® 40 WireFree™ RTS Li-Ion	31"	63"	D	
AC Motors	Bliss™ 10.0 AC	35"	NA	D & E	Open Roll, Fabric Cornice, and 4" Fascia
	Sonessé® 50 RTS AC (120V)	33"	NA	D & E	
	Sonessé® Ultra 50 AC (120V)	39"	NA	D & E	

*Not all fabrics are available in all zones

PRODUCT SIZE SPECIFICATIONS – CONTINUOUS LOOP CONTROL & AUTOMATION

Collection Code	Collection Name	Max Width Non-Railroaded ** (inches)	Max Width Railroaded (inches)	Available with Seam
RB13	Ranger Blackout	110	NA	No
AB026	Delhi Blackout	105	NA	No
AB025	Heritage Blackout	105	NA	No

Top Treatment	Legend				
Medium Cassette					
3" Fascia					
Large Cassette					
Square Cassette					
Fabric Cornice					
4" Fascia					
Open Roll					

**To determine the maximum width for continuous Fabric Cornices, subtract 4 inches from the maximum non-railroad width.

· Railroad Fabrics (turned width for length) will have a visible seam when fabricated longer than the maximum roll width less 16".

· **Red Box** in spec chart indicates shade sizes Heat Sealed Hem Bar is recommended. For Continuous Loop Control, metal chain is also recommended for these sizes.

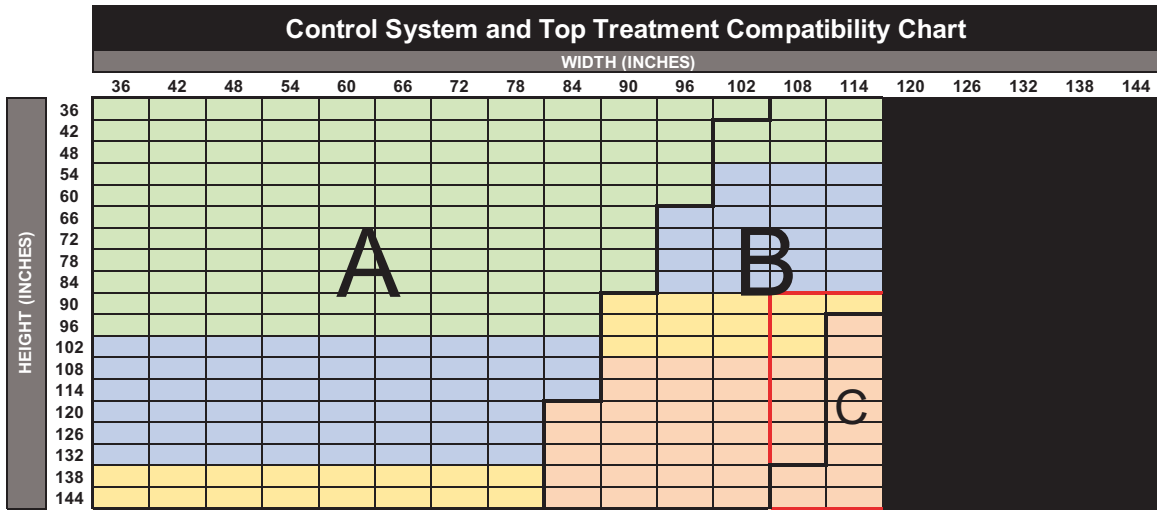

Control Systems (Minimum height for all Control Systems is 12")		Minimum Width (Single Panel)	Overall Minimum Width (2-on-1)	Specification Zone(s)*	Top Treatment
Continuous Loop Control	Continuous Loop Control (Maximum height for 12" width is 60")	12"	24"	A, B & C	All
	**Continuous Loop Control with Spring Assist	60"	NA	A, B & C	Open Roll & 4" Fascia
PowerWand	Powerwand 1.0 Li-Ion	21"	43"	A	All
	Powerwand 2.0 Li-Ion	22"	45"	A & B	(except 3" Fascia)
Lithium-ion Motors	Bliss™ 1.1 Li-Ion	21 1/2"	44"	A	All
	Bliss™ 2.0 Li-Ion	29"	59"	A & B	
	Sonesse® 28 WireFree™ RTS Li-Ion / Sonesse® 28 WireFree™ Zigbee Li-Ion	24 1/2"	50"	A	
	Sonesse® ULTRA 30 WireFree™ RTS Li-Ion	28 1/2"	58"	A & B	
DC Motors	Bliss™ 1.1 DC	16 1/2"	34"	A	All
	Bliss™ 2.0 DC	22 1/2"	46"	A & B	
	Sonesse® 28 WireFree™ RTS DC / Sonesse® 28 WireFree™ Zigbee DC	16 1/2"	34"	A	
	Sonesse® 30 RTS 24v DC	21"	NA	A & B	

**See Spring Assist Section in reference guide for details

*Not all fabrics are available in all zones

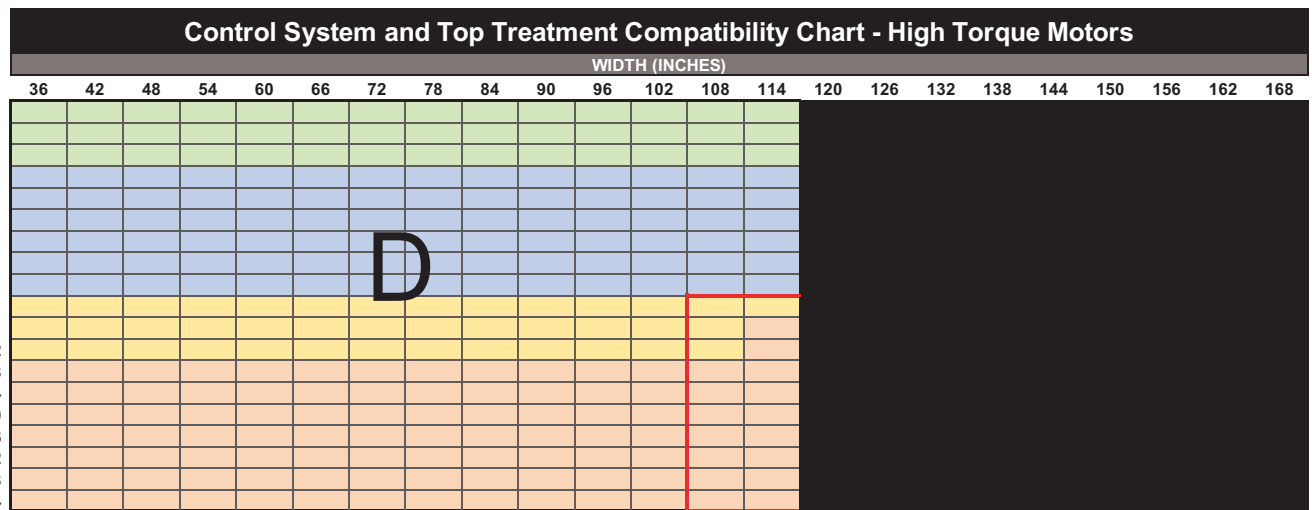

Control Systems (Minimum height for all Control Systems is 12")		Minimum Width (Single Panel)	Overall Minimum Width (2-on-1)	Specification Zone(s)*	Top Treatment
Lithium-ion Motors	Bliss™ 3.0 Li-Ion	32"	65"	D & E	All
	Sonesse® 40 WireFree™ RTS Li-Ion	31"	63"	D	
AC Motors	Bliss™ 10.0 AC	35"	NA	D & E	Open Roll, Fabric Cornice, and 4" Fascia
	Sonesse® 50 RTS AC (120V)	33"	NA	D & E	
	Sonesse® Ultra 50 AC (120V)	39"	NA	D & E	

*Not all fabrics are available in all zones

PRODUCT SIZE SPECIFICATIONS – CONTINUOUS LOOP CONTROL & AUTOMATION

Collection Code	Collection Name	Max Width Non-Railroaded ** (inches)	Max Width Railroaded (inches)	Available with Seam
AF038	Rhine	110	NA	No

**To determine the maximum width for continuous Fabric Cornices, subtract 4 inches from the maximum non-railroad width.

- Railroad Fabrics (turned width for length) will have a visible seam when fabricated longer than the maximum roll width less 16".
- Red Box in spec chart indicates shade sizes Heat Sealed Hem Bar is recommended. For Continuous Loop Control, metal chain is also recommended for these sizes.

Top Treatment	Legend			
Medium Cassette				
3" Fascia				
Large Cassette				
Square Cassette				
Fabric Cornice				
4" Fascia				
Open Roll				

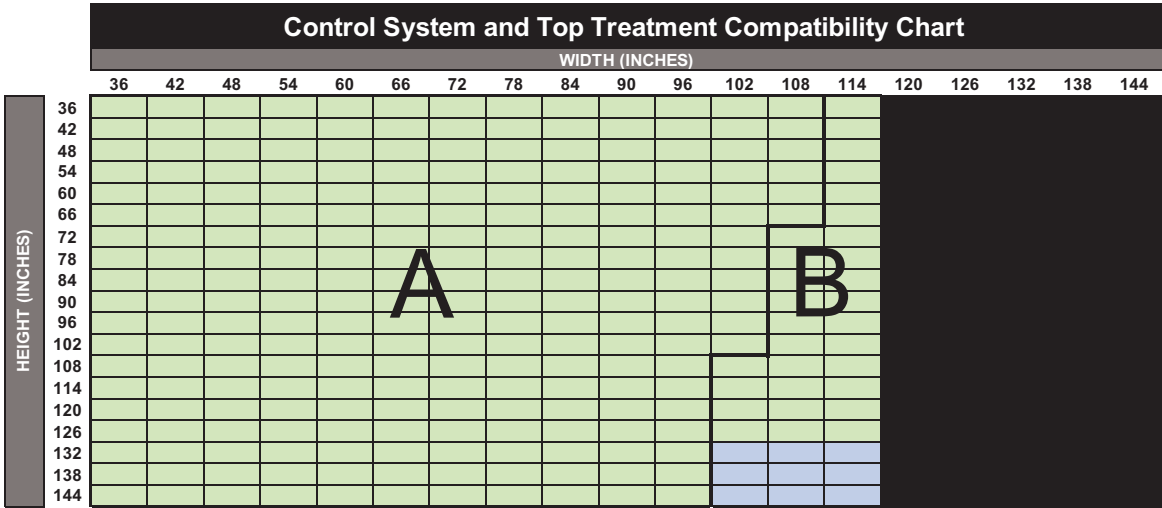

Control Systems (Minimum height for all Control Systems is 12")		Minimum Width (Single Panel)	Overall Minimum Width (2-on-1)	Specification Zone(s)*	Top Treatment
Continuous Loop Control	Continuous Loop Control (Maximum height for 12" width is 60")	12"	24"	A, B & C	All
	**Continuous Loop Control with Spring Assist	60"	NA	A, B & C	Open Roll & 4" Fascia
PowerWand	Powerwand 1.0 Li-Ion	21"	43"	A	All
	Powerwand 2.0 Li-Ion	22"	45"	A & B	(except 3" Fascia)
Lithium-ion Motors	Bliss™ 1.1 Li-Ion	21 1/2"	44"	A	All
	Bliss™ 2.0 Li-Ion	29"	59"	A & B	
	Sonessé® 28 WireFree™ RTS Li-Ion / Sonessé® 28 WireFree™ Zigbee Li-Ion	24 1/2"	50"	A	
	Sonessé® ULTRA 30 WireFree™ RTS Li-Ion	28 1/2"	58"	A & B	
DC Motors	Bliss™ 1.1 DC	16 1/2"	34"	A	All
	Bliss™ 2.0 DC	22 1/2"	46"	A & B	
	Sonessé® 28 WireFree™ RTS DC / Sonessé® 28 WireFree™ Zigbee DC	16 1/2"	34"	A	
	Sonessé® 30 RTS 24v DC	21"	NA	A & B	

**See Spring Assist Section in reference guide for details

*Not all fabrics are available in all zones

Control System and Top Treatment Compatibility Chart - High Torque Motors

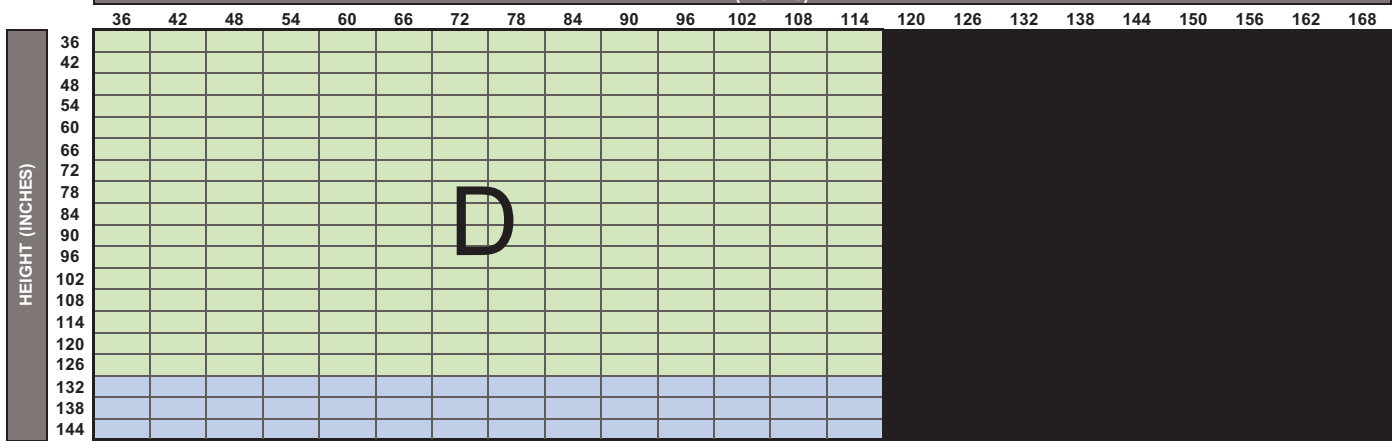

Control Systems (Minimum height for all Control Systems is 12")		Minimum Width (Single Panel)	Overall Minimum Width (2-on-1)	Specification Zone(s)*	Top Treatment
Lithium-ion Motors	Bliss™ 3.0 Li-Ion	32"	65"	D & E	All
	Sonessé® 40 WireFree™ RTS Li-Ion	31"	63"	D	
AC Motors	Bliss™ 10.0 AC	35"	NA	D & E	Open Roll, Fabric Cornice, and 4" Fascia
	Sonessé® 50 RTS AC (120V)	33"	NA	D & E	
	Sonessé® Ultra 50 AC (120V)	39"	NA	D & E	

*Not all fabrics are available in all zones

PRODUCT SIZE SPECIFICATIONS – CONTINUOUS LOOP CONTROL & AUTOMATION

Collection Code	Collection Name	Max Width Non-Railroaded ** (inches)	Max Width Railroaded (inches)	Available with Seam
RF3	Santa Cruz	94	NA	No

**To determine the maximum width for continuous Fabric Cornices, subtract 4 inches from the maximum non-railroad width.

- Railroad Fabrics (turned width for length) will have a visible seam when fabricated longer than the maximum roll width less 16".
- Red Box in spec chart indicates shade sizes Heat Sealed Hem Bar is recommended. For Continuous Loop Control, metal chain is also recommended for these sizes.

Top Treatment	Legend			
Medium Cassette				
3" Fascia				
Large Cassette				
Square Cassette				
Fabric Cornice				
4" Fascia				
Open Roll				

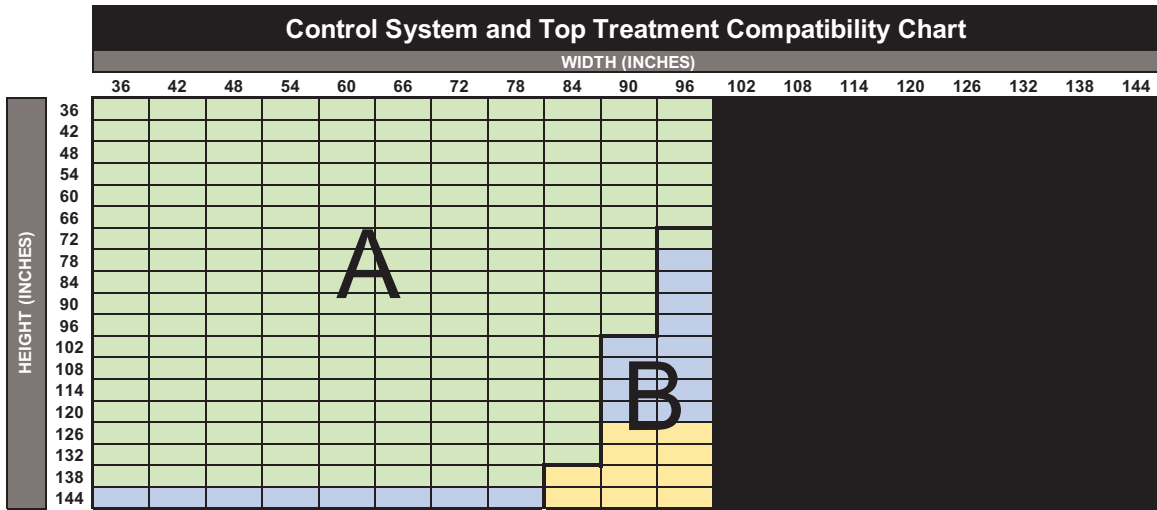

Control Systems (Minimum height for all Control Systems is 12")		Minimum Width (Single Panel)	Overall Minimum Width (2-on-1)	Specification Zone(s)*	Top Treatment
Continuous Loop Control	Continuous Loop Control (Maximum height for 12" width is 60")	12"	24"	A, B & C	All
	**Continuous Loop Control with Spring Assist	60"	NA	A, B & C	Open Roll & 4" Fascia
PowerWand	Powerwand 1.0 Li-Ion	21"	43"	A	All
	Powerwand 2.0 Li-Ion	22"	45"	A & B	(except 3" Fascia)
Lithium-ion Motors	Bliss™ 1.1 Li-Ion	21 1/2"	44"	A	All
	Bliss™ 2.0 Li-Ion	29"	59"	A & B	
	Sonesse® 28 WireFree™ RTS Li-Ion / Sonesse® 28 WireFree™ Zigbee Li-Ion	24 1/2"	50"	A	
	Sonesse® ULTRA 30 WireFree™ RTS Li-Ion	28 1/2"	58"	A & B	
DC Motors	Bliss™ 1.1 DC	16 1/2"	34"	A	All
	Bliss™ 2.0 DC	22 1/2"	46"	A & B	
	Sonesse® 28 WireFree™ RTS DC / Sonesse® 28 WireFree™ Zigbee DC	16 1/2"	34"	A	
	Sonesse® 30 RTS 24v DC	21"	NA	A & B	

**See Spring Assist Section in reference guide for details

*Not all fabrics are available in all zones

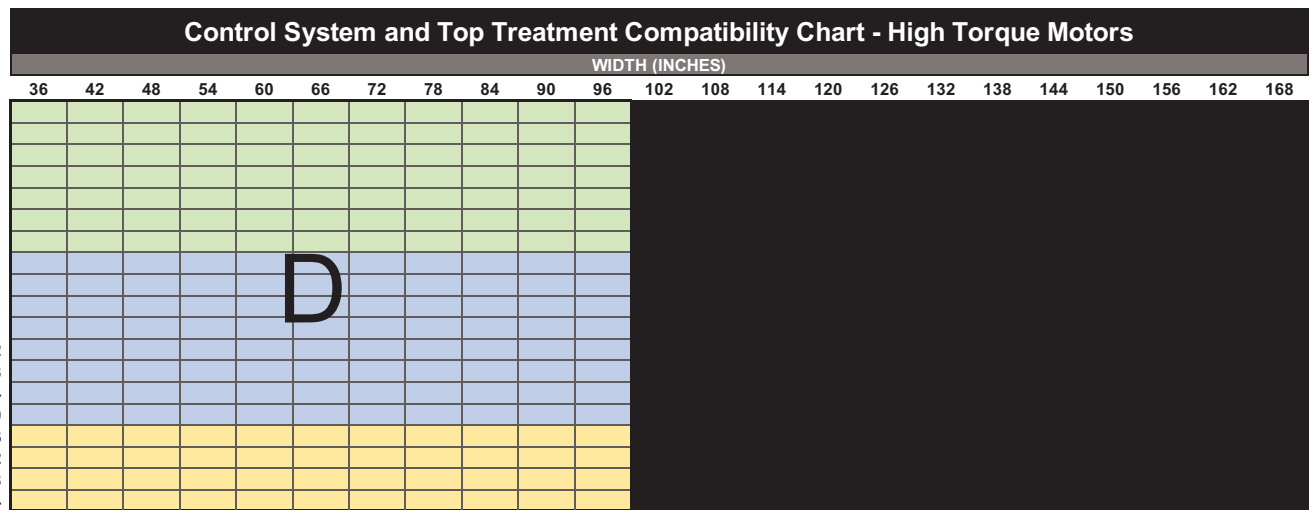

Control Systems (Minimum height for all Control Systems is 12")		Minimum Width (Single Panel)	Overall Minimum Width (2-on-1)	Specification Zone(s)*	Top Treatment
Lithium-ion Motors	Bliss™ 3.0 Li-Ion	32"	65"	D & E	All
	Sonesse® 40 WireFree™ RTS Li-Ion	31"	63"	D	
AC Motors	Bliss™ 10.0 AC	35"	NA	D & E	Open Roll, Fabric Cornice, and 4" Fascia
	Sonesse® 50 RTS AC (120V)	33"	NA	D & E	
	Sonesse® Ultra 50 AC (120V)	39"	NA	D & E	

*Not all fabrics are available in all zones

PRODUCT SIZE SPECIFICATIONS – CONTINUOUS LOOP CONTROL & AUTOMATION

Collection Code	Collection Name	Max Width Non-Railroaded ** (inches)	Max Width Railroaded (inches)	Available with Seam
RB1	Santa Cruz Blackout	94	NA	No

**To determine the maximum width for continuous Fabric Cornices, subtract 4 inches from the maximum non-railroad width.

- Railroad Fabrics (turned width for length) will have a visible seam when fabricated longer than the maximum roll width less 16".
- Red Box in spec chart indicates shade sizes Heat Sealed Hem Bar is recommended. For Continuous Loop Control, metal chain is also recommended for these sizes.

Top Treatment	Legend			
Medium Cassette				
3" Fascia				
Large Cassette				
Square Cassette				
Fabric Cornice				
4" Fascia				
Open Roll				

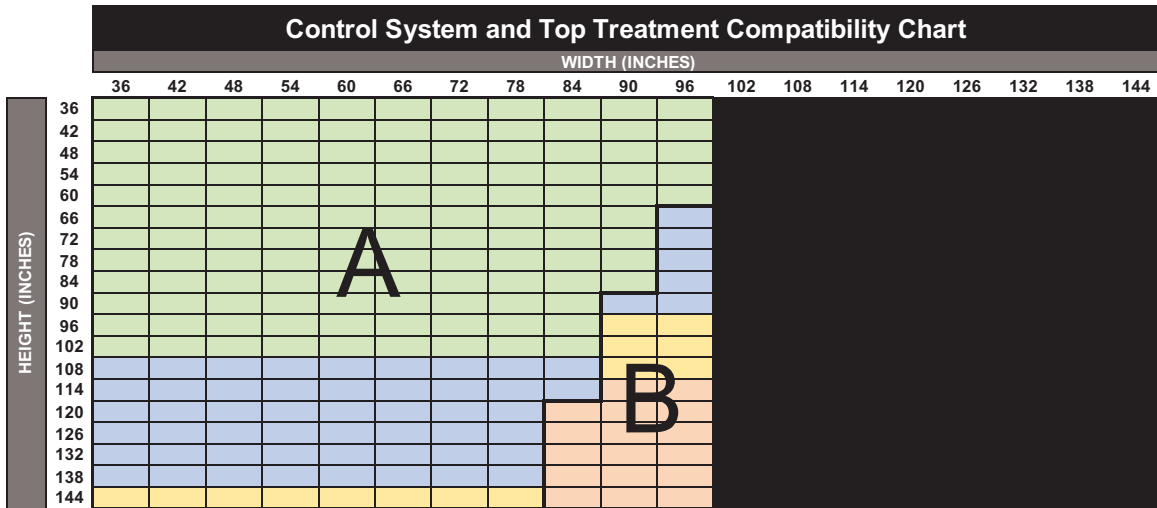

Control Systems (Minimum height for all Control Systems is 12")		Minimum Width (Single Panel)	Overall Minimum Width (2-on-1)	Specification Zone(s)*	Top Treatment
Continuous Loop Control	Continuous Loop Control (Maximum height for 12" width is 60")	12"	24"	A, B & C	All
	**Continuous Loop Control with Spring Assist	60"	NA	A, B & C	Open Roll & 4" Fascia
PowerWand	Powerwand 1.0 Li-Ion	21"	43"	A	All
	Powerwand 2.0 Li-Ion	22"	45"	A & B	(except 3" Fascia)
Lithium-ion Motors	Bliss™ 1.1 Li-Ion	21 1/2"	44"	A	All
	Bliss™ 2.0 Li-Ion	29"	59"	A & B	
	Sonessé® 28 WireFree™ RTS Li-Ion / Sonessé® 28 WireFree™ Zigbee Li-Ion	24 1/2"	50"	A	
	Sonessé® ULTRA 30 WireFree™ RTS Li-Ion	28 1/2"	58"	A & B	
DC Motors	Bliss™ 1.1 DC	16 1/2"	34"	A	All
	Bliss™ 2.0 DC	22 1/2"	46"	A & B	
	Sonessé® 28 WireFree™ RTS DC / Sonessé® 28 WireFree™ Zigbee DC	16 1/2"	34"	A	
	Sonessé® 30 RTS 24v DC	21"	NA	A & B	

**See Spring Assist Section in reference guide for details

*Not all fabrics are available in all zones

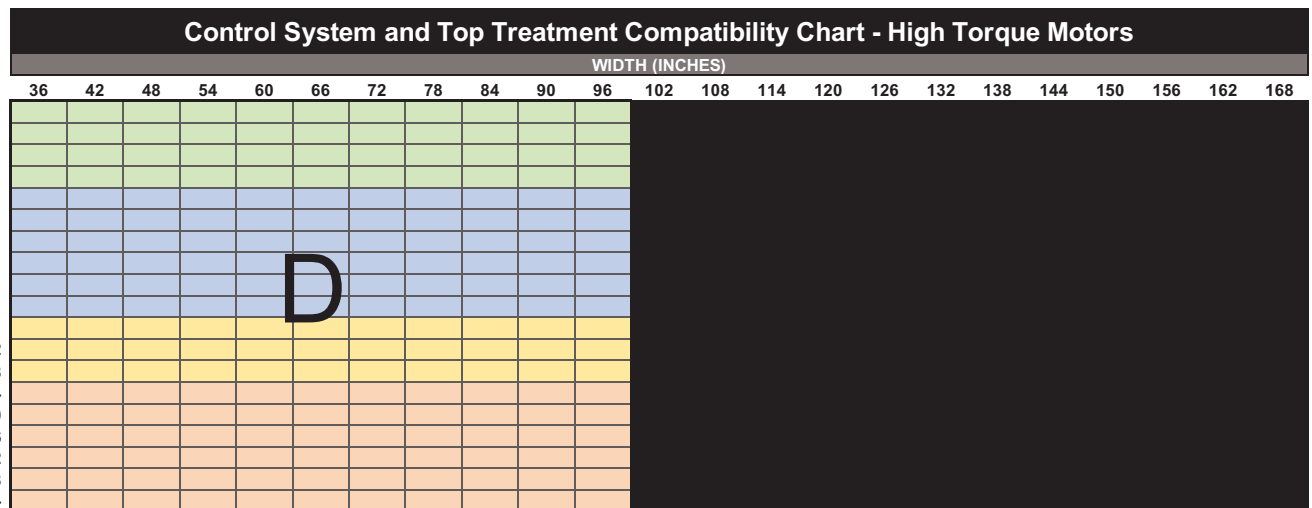

Control Systems (Minimum height for all Control Systems is 12")		Minimum Width (Single Panel)	Overall Minimum Width (2-on-1)	Specification Zone(s)*	Top Treatment
Lithium-ion Motors	Bliss™ 3.0 Li-Ion	32"	65"	D & E	All
	Sonessé® 40 WireFree™ RTS Li-Ion	31"	63"	D	
AC Motors	Bliss™ 10.0 AC	35"	NA	D & E	Open Roll, Fabric Cornice, and 4" Fascia
	Sonessé® 50 RTS AC (120V)	33"	NA	D & E	
	Sonessé® Ultra 50 AC (120V)	39"	NA	D & E	

*Not all fabrics are available in all zones

PRODUCT SIZE SPECIFICATIONS – CONTINUOUS LOOP CONTROL & AUTOMATION

Collection Code	Collection Name	Max Width Non-Railroaded ** (inches)	Max Width Railroaded (inches)	Available with Seam
R100	Scala Blackout	110	168	Yes

**To determine the maximum width for continuous Fabric Cornices, subtract 4 inches from the maximum non-railroad width.

- Railroad Fabrics (turned width for length) will have a visible seam when fabricated longer than the maximum roll width less 16".
- Red Box in spec chart indicates shade sizes Heat Sealed Hem Bar is recommended. For Continuous Loop Control, metal chain is also recommended for these sizes.

Top Treatment	Legend			
Medium Cassette				
3" Fascia				
Large Cassette				
Square Cassette				
Fabric Cornice				
4" Fascia				
Open Roll				

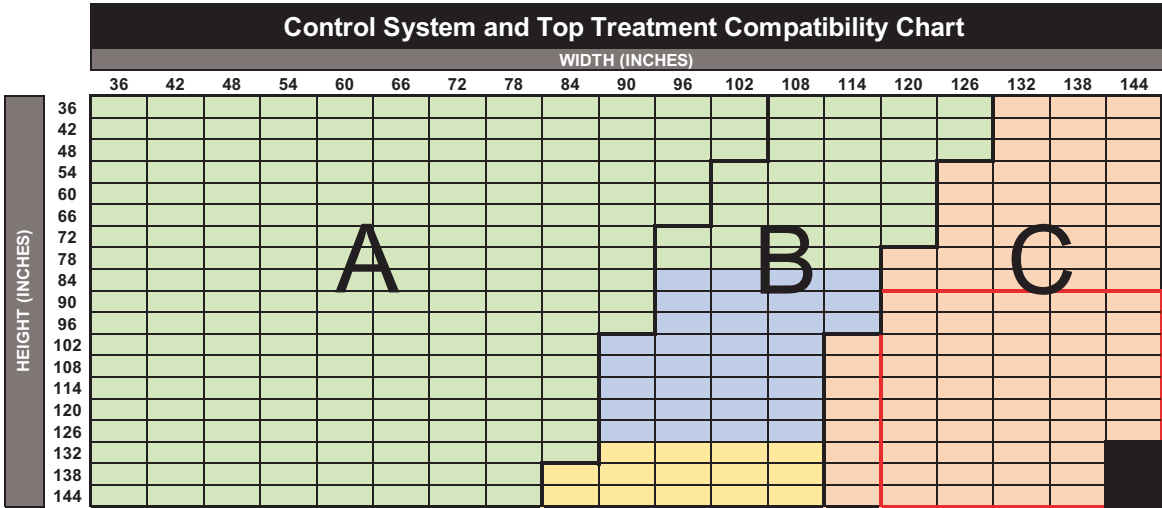

Control Systems (Minimum height for all Control Systems is 12")		Minimum Width (Single Panel)	Overall Minimum Width (2-on-1)	Specification Zone(s)*	Top Treatment
Continuous Loop Control	Continuous Loop Control (Maximum height for 12" width is 60")	12"	24"	A, B & C	All
	**Continuous Loop Control with Spring Assist	60"	NA	A, B & C	Open Roll & 4" Fascia
PowerWand	Powerwand 1.0 Li-Ion	21"	43"	A	All
	Powerwand 2.0 Li-Ion	22"	45"	A & B	(except 3" Fascia)
Lithium-ion Motors	Bliss™ 1.1 Li-Ion	21 1/2"	44"	A	All
	Bliss™ 2.0 Li-Ion	29"	59"	A & B	
	Sonessé® 28 WireFree™ RTS Li-Ion / Sonessé® 28 WireFree™ Zigbee Li-Ion	24 1/2"	50"	A	
	Sonessé® ULTRA 30 WireFree™ RTS Li-Ion	28 1/2"	58"	A & B	
DC Motors	Bliss™ 1.1 DC	16 1/2"	34"	A	All
	Bliss™ 2.0 DC	22 1/2"	46"	A & B	
	Sonessé® 28 WireFree™ RTS DC / Sonessé® 28 WireFree™ Zigbee DC	16 1/2"	34"	A	
	Sonessé® 30 RTS 24v DC	21"	NA	A & B	

**See Spring Assist Section in reference guide for details

*Not all fabrics are available in all zones

Control System and Top Treatment Compatibility Chart - High Torque Motors

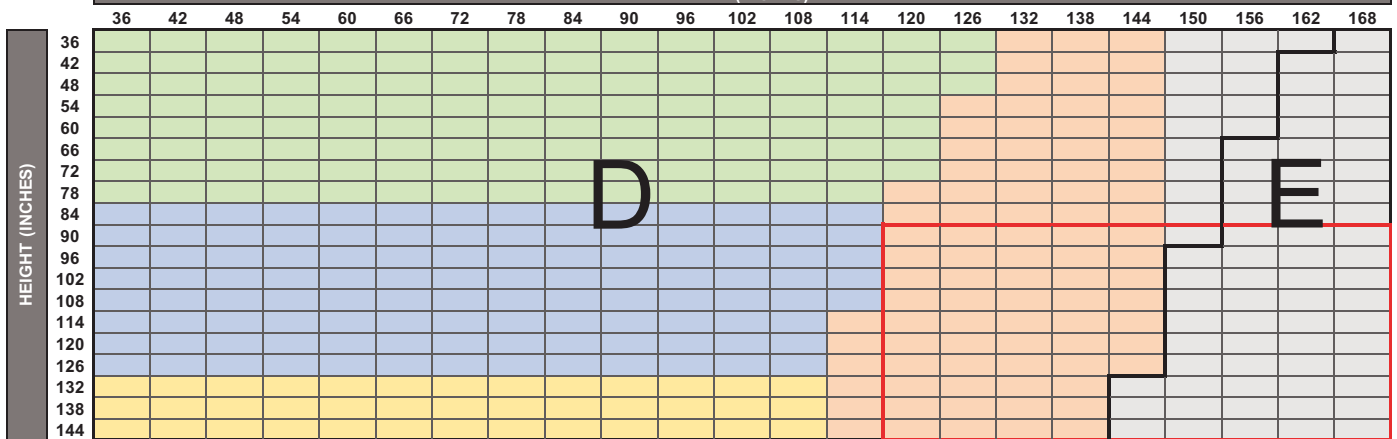

Control Systems (Minimum height for all Control Systems is 12")		Minimum Width (Single Panel)	Overall Minimum Width (2-on-1)	Specification Zone(s)*	Top Treatment
Lithium-ion Motors	Bliss™ 3.0 Li-Ion	32"	65"	D & E	All
	Sonessé® 40 WireFree™ RTS Li-Ion	31"	63"	D	
AC Motors	Bliss™ 10.0 AC	35"	NA	D & E	Open Roll, Fabric Cornice, and 4" Fascia
	Sonessé® 50 RTS AC (120V)	33"	NA	D & E	
	Sonessé® Ultra 50 AC (120V)	39"	NA	D & E	

*Not all fabrics are available in all zones

PRODUCT SIZE SPECIFICATIONS – CONTINUOUS LOOP CONTROL & AUTOMATION

Collection Code	Collection Name	Max Width Non-Railroaded ** (inches)	Max Width Railroaded (inches)	Available with Seam
AF039	Sequoia	110	168	Yes

**To determine the maximum width for continuous Fabric Cornices, subtract 4 inches from the maximum non-railroad width.

· Railroad Fabrics (turned width for length) will have a visible seam when fabricated longer than the maximum roll width less 16".
 · Red Box in spec chart indicates shade sizes Heat Sealed Hem Bar is recommended. For Continuous Loop Control, metal chain is also recommended for these sizes.

Top Treatment	Legend			
Medium Cassette				
3" Fascia				
Large Cassette				
Square Cassette				
Fabric Cornice				
4" Fascia				
Open Roll				

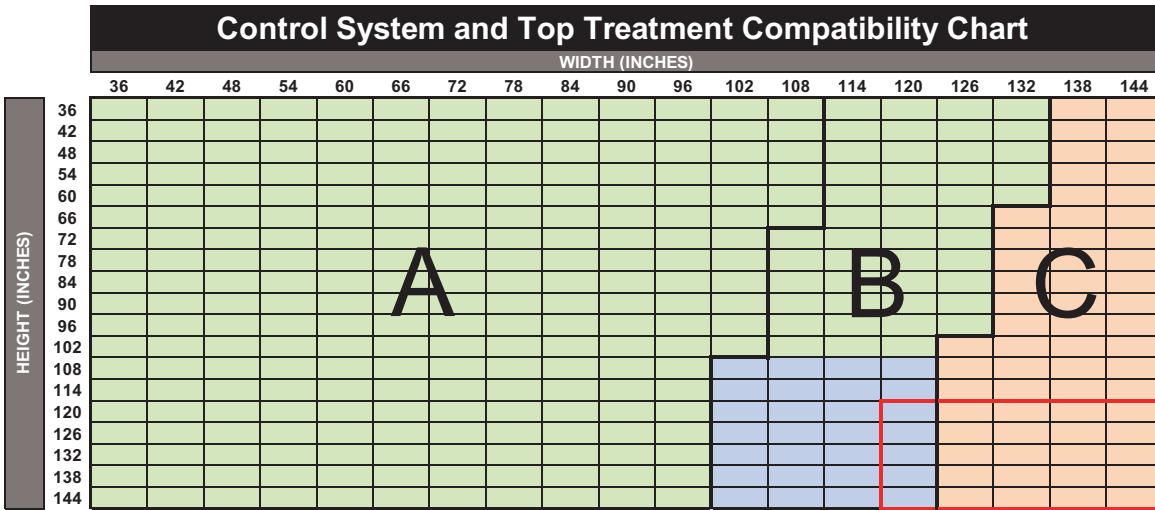

Control Systems (Minimum height for all Control Systems is 12")		Minimum Width (Single Panel)	Overall Minimum Width (2-on-1)	Specification Zone(s)*	Top Treatment
Continuous Loop Control	Continuous Loop Control (Maximum height for 12" width is 60")	12"	24"	A, B & C	All
	**Continuous Loop Control with Spring Assist	60"	NA	A, B & C	Open Roll & 4" Fascia
PowerWand	Powerwand 1.0 Li-Ion	21"	43"	A	All (except 3" Fascia)
	Powerwand 2.0 Li-Ion	22"	45"	A & B	
Lithium-ion Motors	Bliss™ 1.1 Li-Ion	21 1/2"	44"	A	All
	Bliss™ 2.0 Li-Ion	29"	59"	A & B	
	Sonessé® 28 WireFree™ RTS Li-Ion / Sonessé® 28 WireFree™ Zigbee Li-Ion	24 1/2"	50"	A	
	Sonessé® ULTRA 30 WireFree™ RTS Li-Ion	28 1/2"	58"	A & B	
DC Motors	Bliss™ 1.1 DC	16 1/2"	34"	A	All
	Bliss™ 2.0 DC	22 1/2"	46"	A & B	
	Sonessé® 28 WireFree™ RTS DC / Sonessé® 28 WireFree™ Zigbee DC	16 1/2"	34"	A	
	Sonessé® 30 RTS 24v DC	21"	NA	A & B	

**See Spring Assist Section in reference guide for details

*Not all fabrics are available in all zones

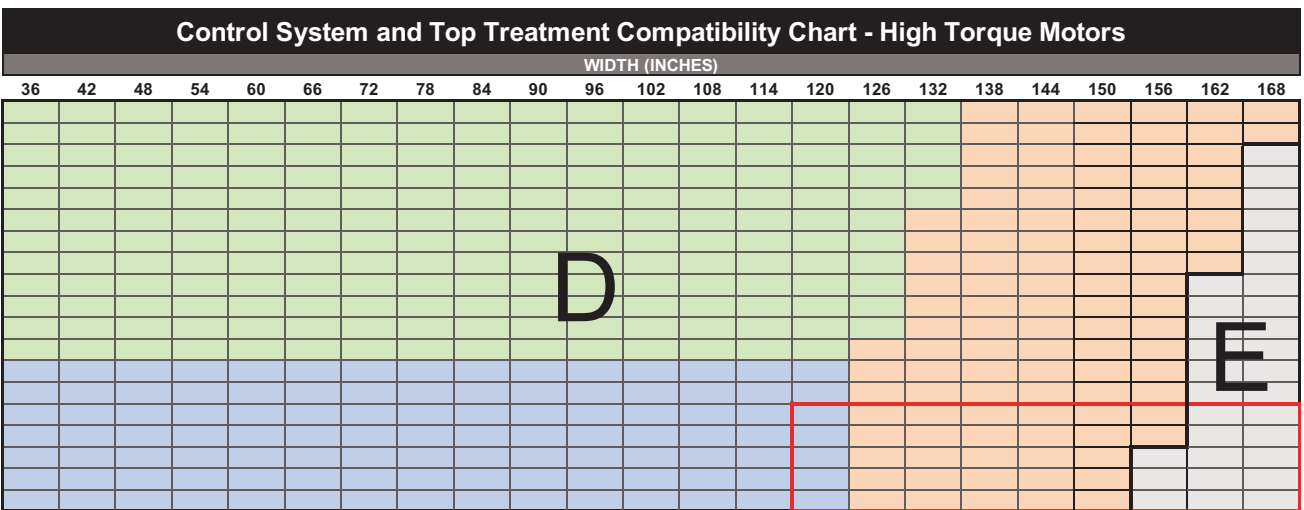

Control Systems (Minimum height for all Control Systems is 12")		Minimum Width (Single Panel)	Overall Minimum Width (2-on-1)	Specification Zone(s)*	Top Treatment
Lithium-ion Motors	Bliss™ 3.0 Li-Ion	32"	65"	D & E	All
	Sonessé® 40 WireFree™ RTS Li-Ion	31"	63"	D	
AC Motors	Bliss™ 10.0 AC	35"	NA	D & E	Open Roll, Fabric Cornice, and 4" Fascia
	Sonessé® 50 RTS AC (120V)	33"	NA	D & E	
	Sonessé® Ultra 50 AC (120V)	39"	NA	D & E	

*Not all fabrics are available in all zones

PRODUCT SIZE SPECIFICATIONS – CONTINUOUS LOOP CONTROL & AUTOMATION

Collection Code	Collection Name	Max Width Non-Railroaded ** (inches)	Max Width Railroaded (inches)	Available with Seam
R11	Sheerweave 7000	118	168	Yes

**To determine the maximum width for continuous Fabric Cornices, subtract 4 inches from the maximum non-railroad width.

- Railroad Fabrics (turned width for length) will have a visible seam when fabricated longer than the maximum roll width less 16".
- Red Box in spec chart indicates shade sizes Heat Sealed Hem Bar is recommended. For Continuous Loop Control, metal chain is also recommended for these sizes.

Top Treatment	Legend			
Medium Cassette				
3" Fascia				
Large Cassette				
Square Cassette				
Fabric Cornice				
4" Fascia				
Open Roll				

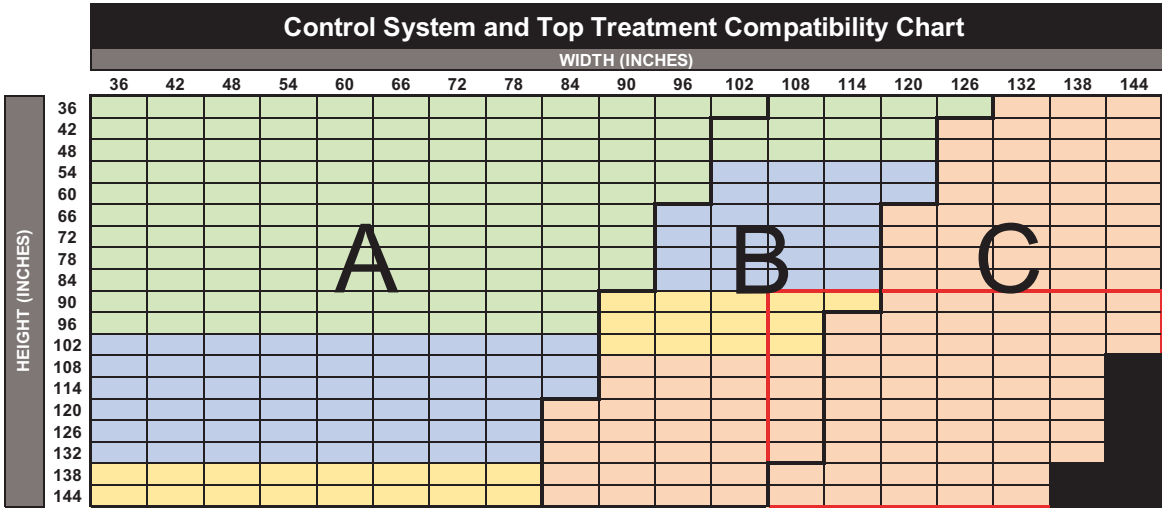

Control Systems (Minimum height for all Control Systems is 12")		Minimum Width (Single Panel)	Overall Minimum Width (2-on-1)	Specification Zone(s)*	Top Treatment
Continuous Loop Control	Continuous Loop Control (Maximum height for 12" width is 60")	12"	24"	A, B & C	All
	**Continuous Loop Control with Spring Assist	60"	NA	A, B & C	Open Roll & 4" Fascia
PowerWand	Powerwand 1.0 Li-Ion	21"	43"	A	All
	Powerwand 2.0 Li-Ion	22"	45"	A & B	(except 3" Fascia)
Lithium-ion Motors	Bliss™ 1.1 Li-Ion	21 1/2"	44"	A	All
	Bliss™ 2.0 Li-Ion	29"	59"	A & B	
	Sonesse® 28 WireFree™ RTS Li-Ion / Sonesse® 28 WireFree™ Zigbee Li-Ion	24 1/2"	50"	A	
	Sonesse® ULTRA 30 WireFree™ RTS Li-Ion	28 1/2"	58"	A & B	
DC Motors	Bliss™ 1.1 DC	16 1/2"	34"	A	All
	Bliss™ 2.0 DC	22 1/2"	46"	A & B	
	Sonesse® 28 WireFree™ RTS DC / Sonesse® 28 WireFree™ Zigbee DC	16 1/2"	34"	A	
	Sonesse® 30 RTS 24v DC	21"	NA	A & B	

**See Spring Assist Section in reference guide for details

*Not all fabrics are available in all zones

Control System and Top Treatment Compatibility Chart - High Torque Motors

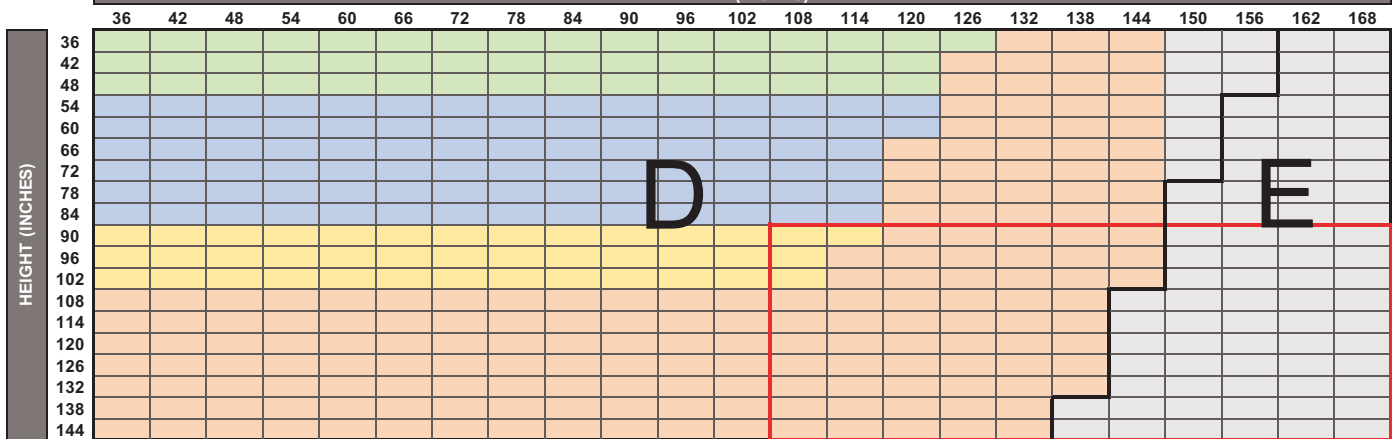

Control Systems (Minimum height for all Control Systems is 12")		Minimum Width (Single Panel)	Overall Minimum Width (2-on-1)	Specification Zone(s)*	Top Treatment
Lithium-ion Motors	Bliss™ 3.0 Li-Ion	32"	65"	D & E	All
	Sonesse® 40 WireFree™ RTS Li-Ion	31"	63"	D	
AC Motors	Bliss™ 10.0 AC	35"	NA	D & E	Open Roll, Fabric Cornice, and 4" Fascia
	Sonesse® 50 RTS AC (120V)	33"	NA	D & E	
	Sonesse® Ultra 50 AC (120V)	39"	NA	D & E	

*Not all fabrics are available in all zones

PRODUCT SIZE SPECIFICATIONS – CONTINUOUS LOOP CONTROL & AUTOMATION

Collection Code	Collection Name	Max Width Non-Railroaded ** (inches)	Max Width Railroaded (inches)	Available with Seam
P7200R	Sheerweave 7200R	118	NA	No

**To determine the maximum width for continuous Fabric Cornices, subtract 4 inches from the maximum non-railroad width.

- Railroad Fabrics (turned width for length) will have a visible seam when fabricated longer than the maximum roll width less 16".
- Red Box in spec chart indicates shade sizes Heat Sealed Hem Bar is recommended. For Continuous Loop Control, metal chain is also recommended for these sizes.

Top Treatment	Legend			
Medium Cassette				
3" Fascia				
Large Cassette				
Square Cassette				
Fabric Cornice				
4" Fascia				
Open Roll				

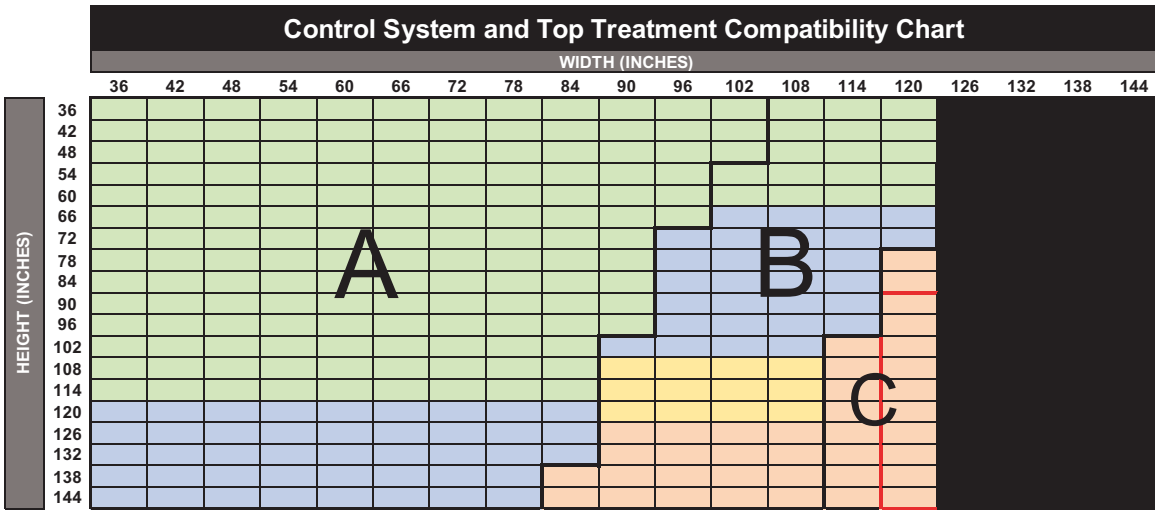

Control Systems (Minimum height for all Control Systems is 12")		Minimum Width (Single Panel)	Overall Minimum Width (2-on-1)	Specification Zone(s)*	Top Treatment
Continuous Loop Control	Continuous Loop Control (Maximum height for 12" width is 60")	12"	24"	A, B & C	All
	**Continuous Loop Control with Spring Assist	60"	NA	A, B & C	Open Roll & 4" Fascia
PowerWand	Powerwand 1.0 Li-Ion	21"	43"	A	All
	Powerwand 2.0 Li-Ion	22"	45"	A & B	(except 3" Fascia)
Lithium-ion Motors	Bliss™ 1.1 Li-Ion	21 1/2"	44"	A	All
	Bliss™ 2.0 Li-Ion	29"	59"	A & B	
	Sonessé® 28 WireFree™ RTS Li-Ion / Sonessé® 28 WireFree™ Zigbee Li-Ion	24 1/2"	50"	A	
	Sonessé® ULTRA 30 WireFree™ RTS Li-Ion	28 1/2"	58"	A & B	
DC Motors	Bliss™ 1.1 DC	16 1/2"	34"	A	All
	Bliss™ 2.0 DC	22 1/2"	46"	A & B	
	Sonessé® 28 WireFree™ RTS DC / Sonessé® 28 WireFree™ Zigbee DC	16 1/2"	34"	A	
	Sonessé® 30 RTS 24v DC	21"	NA	A & B	

**See Spring Assist Section in reference guide for details

*Not all fabrics are available in all zones

Control System and Top Treatment Compatibility Chart - High Torque Motors

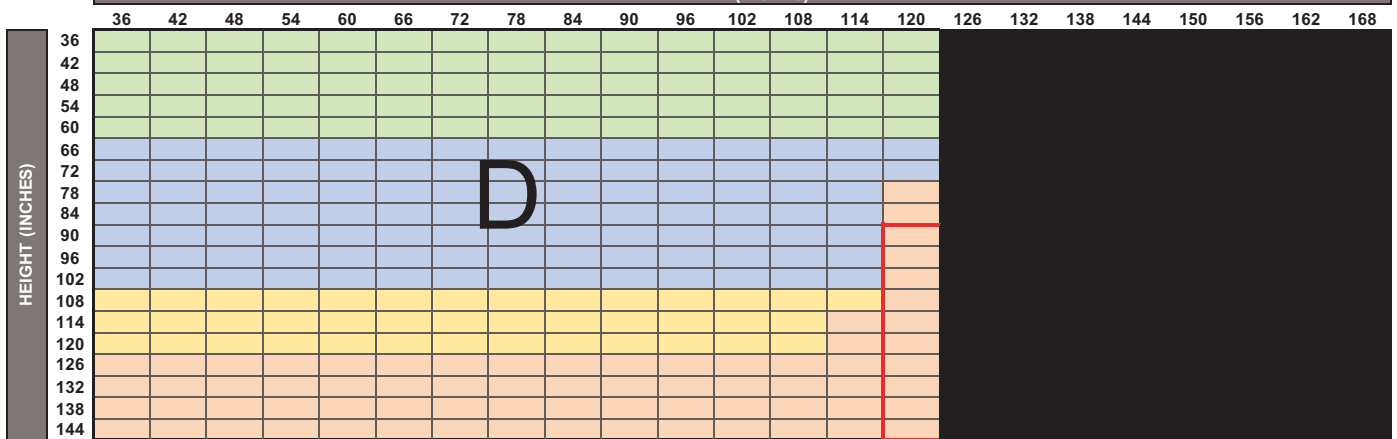

Control Systems (Minimum height for all Control Systems is 12")		Minimum Width (Single Panel)	Overall Minimum Width (2-on-1)	Specification Zone(s)*	Top Treatment
Lithium-ion Motors	Bliss™ 3.0 Li-Ion	32"	65"	D & E	All
	Sonessé® 40 WireFree™ RTS Li-Ion	31"	63"	D	
AC Motors	Bliss™ 10.0 AC	35"	NA	D & E	Open Roll, Fabric Cornice, and 4" Fascia
	Sonessé® 50 RTS AC (120V)	33"	NA	D & E	
	Sonessé® Ultra 50 AC (120V)	39"	NA	D & E	

*Not all fabrics are available in all zones

PRODUCT SIZE SPECIFICATIONS – CONTINUOUS LOOP CONTROL & AUTOMATION

Collection Code	Collection Name	Max Width Non-Railroaded ** (inches)	Max Width Railroaded (inches)	Available with Seam
P7250R	Sheerweave 7250R	118	NA	No

**To determine the maximum width for continuous Fabric Cornices, subtract 4 inches from the maximum non-railroad width.

· Railroad Fabrics (turned width for length) will have a visible seam when fabricated longer than the maximum roll width less 16".
 · Red Box in spec chart indicates shade sizes Heat Sealed Hem Bar is recommended. For Continuous Loop Control, metal chain is also recommended for these sizes.

Top Treatment	Legend			
Medium Cassette				
3" Fascia				
Large Cassette				
Square Cassette				
Fabric Cornice				
4" Fascia				
Open Roll				

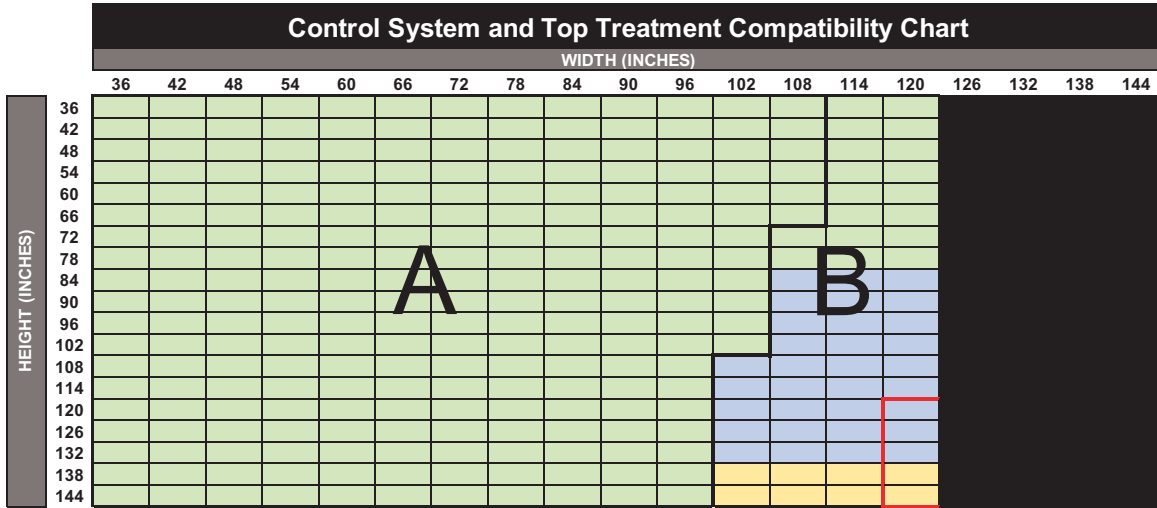

Control Systems (Minimum height for all Control Systems is 12")		Minimum Width (Single Panel)	Overall Minimum Width (2-on-1)	Specification Zone(s)*	Top Treatment
Continuous Loop Control	Continuous Loop Control (Maximum height for 12" width is 60")	12"	24"	A, B & C	All
	**Continuous Loop Control with Spring Assist	60"	NA	A, B & C	Open Roll & 4" Fascia
PowerWand	Powerwand 1.0 Li-Ion	21"	43"	A	All
	Powerwand 2.0 Li-Ion	22"	45"	A & B	(except 3" Fascia)
Lithium-ion Motors	Bliss™ 1.1 Li-Ion	21 1/2"	44"	A	All
	Bliss™ 2.0 Li-Ion	29"	59"	A & B	
	Sonessé® 28 WireFree™ RTS Li-Ion / Sonessé® 28 WireFree™ Zigbee Li-Ion	24 1/2"	50"	A	
	Sonessé® ULTRA 30 WireFree™ RTS Li-Ion	28 1/2"	58"	A & B	
DC Motors	Bliss™ 1.1 DC	16 1/2"	34"	A	All
	Bliss™ 2.0 DC	22 1/2"	46"	A & B	
	Sonessé® 28 WireFree™ RTS DC / Sonessé® 28 WireFree™ Zigbee DC	16 1/2"	34"	A	
	Sonessé® 30 RTS 24v DC	21"	NA	A & B	

**See Spring Assist Section in reference guide for details

*Not all fabrics are available in all zones

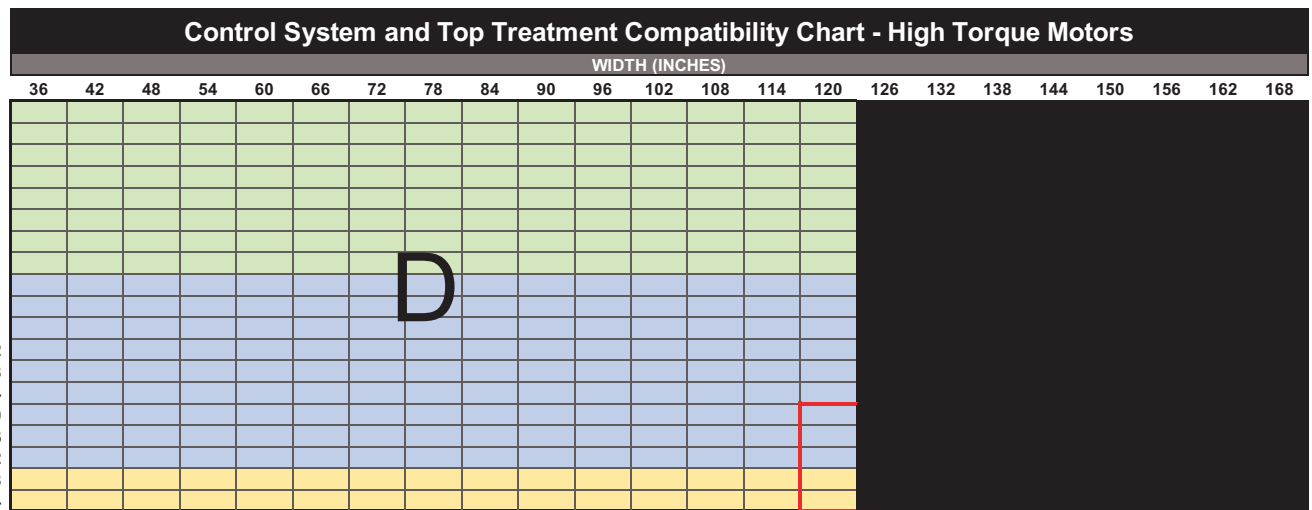

Control Systems (Minimum height for all Control Systems is 12")		Minimum Width (Single Panel)	Overall Minimum Width (2-on-1)	Specification Zone(s)*	Top Treatment
Lithium-ion Motors	Bliss™ 3.0 Li-Ion	32"	65"	D & E	All
	Sonessé® 40 WireFree™ RTS Li-Ion	31"	63"	D	
AC Motors	Bliss™ 10.0 AC	35"	NA	D & E	Open Roll, Fabric Cornice, and 4" Fascia
	Sonessé® 50 RTS AC (120V)	33"	NA	D & E	
	Sonessé® Ultra 50 AC (120V)	39"	NA	D & E	

*Not all fabrics are available in all zones

PRODUCT SIZE SPECIFICATIONS – CONTINUOUS LOOP CONTROL & AUTOMATION

Collection Code	Collection Name	Max Width Non-Railroaded ** (inches)	Max Width Railroaded (inches)	Available with Seam
P7400	Sheerweave 7400	118	NA	No

**To determine the maximum width for continuous Fabric Cornices, subtract 4 inches from the maximum non-railroad width.

- Railroad Fabrics (turned width for length) will have a visible seam when fabricated longer than the maximum roll width less 16".
- Red Box in spec chart indicates shade sizes Heat Sealed Hem Bar is recommended. For Continuous Loop Control, metal chain is also recommended for these sizes.

Top Treatment	Legend			
Medium Cassette				
3" Fascia				
Large Cassette				
Square Cassette				
Fabric Cornice				
4" Fascia				
Open Roll				

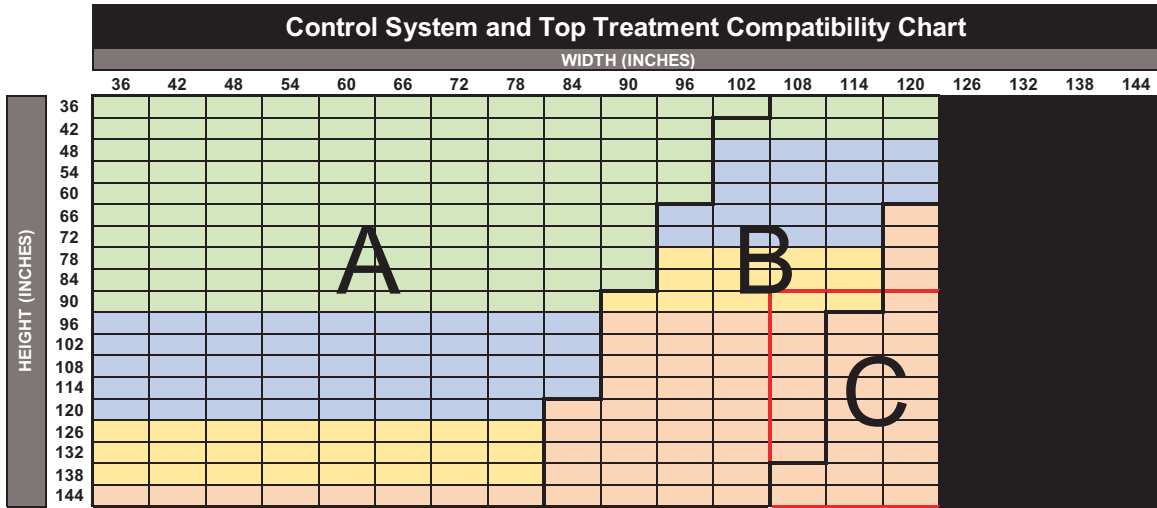

Control Systems (Minimum height for all Control Systems is 12")		Minimum Width (Single Panel)	Overall Minimum Width (2-on-1)	Specification Zone(s)*	Top Treatment
Continuous Loop Control	Continuous Loop Control (Maximum height for 12" width is 60")	12"	24"	A, B & C	All
	**Continuous Loop Control with Spring Assist	60"	NA	A, B & C	Open Roll & 4" Fascia
PowerWand	Powerwand 1.0 Li-Ion	21"	43"	A	All
	Powerwand 2.0 Li-Ion	22"	45"	A & B	(except 3" Fascia)
Lithium-ion Motors	Bliss™ 1.1 Li-Ion	21 1/2"	44"	A	All
	Bliss™ 2.0 Li-Ion	29"	59"	A & B	
	Sonessé® 28 WireFree™ RTS Li-Ion / Sonessé® 28 WireFree™ Zigbee Li-Ion	24 1/2"	50"	A	
	Sonessé® ULTRA 30 WireFree™ RTS Li-Ion	28 1/2"	58"	A & B	
DC Motors	Bliss™ 1.1 DC	16 1/2"	34"	A	All
	Bliss™ 2.0 DC	22 1/2"	46"	A & B	
	Sonessé® 28 WireFree™ RTS DC / Sonessé® 28 WireFree™ Zigbee DC	16 1/2"	34"	A	
	Sonessé® 30 RTS 24v DC	21"	NA	A & B	

**See Spring Assist Section in reference guide for details

*Not all fabrics are available in all zones

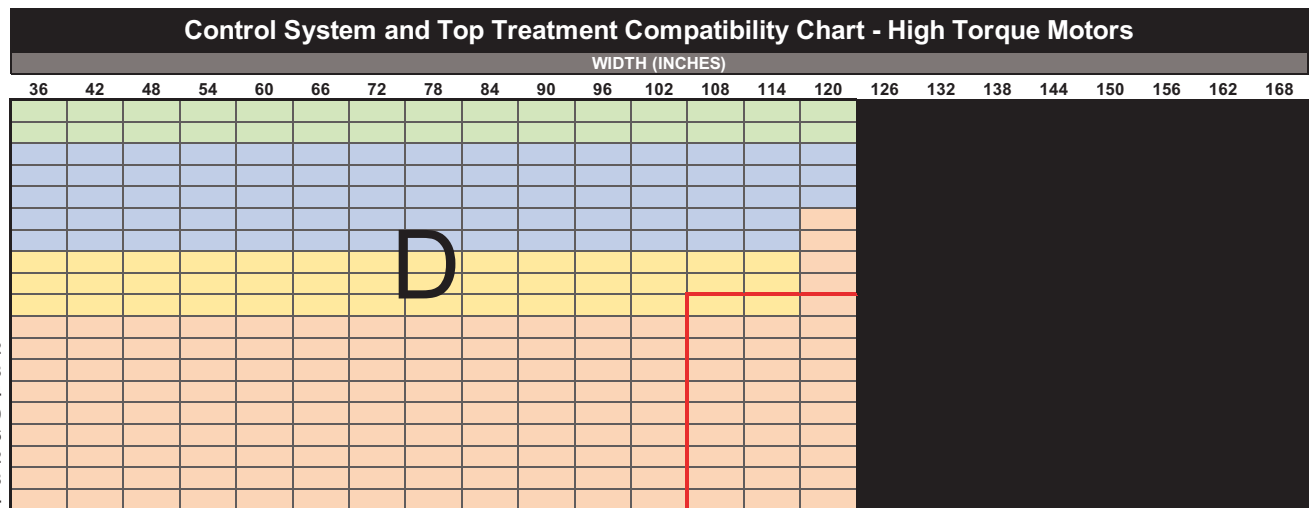

Control Systems (Minimum height for all Control Systems is 12")		Minimum Width (Single Panel)	Overall Minimum Width (2-on-1)	Specification Zone(s)*	Top Treatment
Lithium-ion Motors	Bliss™ 3.0 Li-Ion	32"	65"	D & E	All
	Sonessé® 40 WireFree™ RTS Li-Ion	31"	63"	D	
AC Motors	Bliss™ 10.0 AC	35"	NA	D & E	Open Roll, Fabric Cornice, and 4" Fascia
	Sonessé® 50 RTS AC (120V)	33"	NA	D & E	
	Sonessé® Ultra 50 AC (120V)	39"	NA	D & E	

*Not all fabrics are available in all zones

PRODUCT SIZE SPECIFICATIONS – CONTINUOUS LOOP CONTROL & AUTOMATION

Collection Code	Collection Name	Max Width Non-Railroaded ** (inches)	Max Width Railroaded (inches)	Available with Seam
P7450	Sheerweave 7450	118	NA	No

**To determine the maximum width for continuous Fabric Cornices, subtract 4 inches from the maximum non-railroad width.

- Railroad Fabrics (turned width for length) will have a visible seam when fabricated longer than the maximum roll width less 16".
- Red Box in spec chart indicates shade sizes Heat Sealed Hem Bar is recommended. For Continuous Loop Control, metal chain is also recommended for these sizes.

Top Treatment	Legend			
Medium Cassette				
3" Fascia				
Large Cassette				
Square Cassette				
Fabric Cornice				
4" Fascia				
Open Roll				

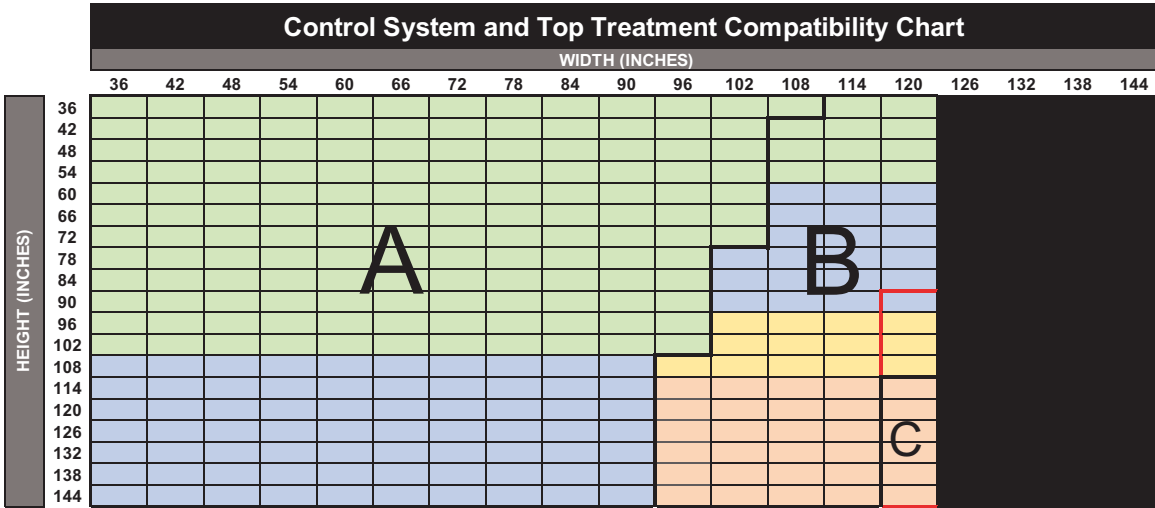

Control Systems (Minimum height for all Control Systems is 12")		Minimum Width (Single Panel)	Overall Minimum Width (2-on-1)	Specification Zone(s)*	Top Treatment
Continuous Loop Control	Continuous Loop Control (Maximum height for 12" width is 60")	12"	24"	A, B & C	All
	**Continuous Loop Control with Spring Assist	60"	NA	A, B & C	Open Roll & 4" Fascia
PowerWand	Powerwand 1.0 Li-Ion	21"	43"	A	All
	Powerwand 2.0 Li-Ion	22"	45"	A & B	(except 3" Fascia)
Lithium-ion Motors	Bliss™ 1.1 Li-Ion	21 1/2"	44"	A	All
	Bliss™ 2.0 Li-Ion	29"	59"	A & B	
	Sonessé® 28 WireFree™ RTS Li-Ion / Sonessé® 28 WireFree™ Zigbee Li-Ion	24 1/2"	50"	A	
	Sonessé® ULTRA 30 WireFree™ RTS Li-Ion	28 1/2"	58"	A & B	
DC Motors	Bliss™ 1.1 DC	16 1/2"	34"	A	All
	Bliss™ 2.0 DC	22 1/2"	46"	A & B	
	Sonessé® 28 WireFree™ RTS DC / Sonessé® 28 WireFree™ Zigbee DC	16 1/2"	34"	A	
	Sonessé® 30 RTS 24v DC	21"	NA	A & B	

**See Spring Assist Section in reference guide for details

*Not all fabrics are available in all zones

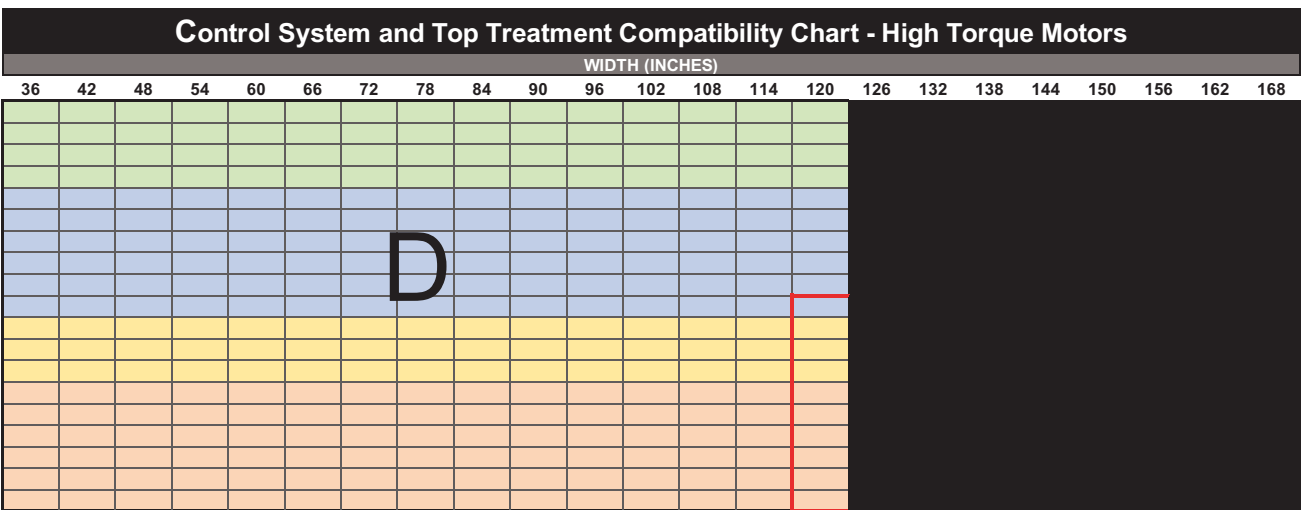

Control Systems (Minimum height for all Control Systems is 12")		Minimum Width (Single Panel)	Overall Minimum Width (2-on-1)	Specification Zone(s)*	Top Treatment
Lithium-ion Motors	Bliss™ 3.0 Li-Ion	32"	65"	D & E	All
	Sonessé® 40 WireFree™ RTS Li-Ion	31"	63"	D	
AC Motors	Bliss™ 10.0 AC	35"	NA	D & E	Open Roll, Fabric Cornice, and 4" Fascia
	Sonessé® 50 RTS AC (120V)	33"	NA	D & E	
	Sonessé® Ultra 50 AC (120V)	39"	NA	D & E	

*Not all fabrics are available in all zones

PRODUCT SIZE SPECIFICATIONS – CONTINUOUS LOOP CONTROL & AUTOMATION

Collection Code	Collection Name	Max Width Non-Railroaded ** (inches)	Max Width Railroaded (inches)	Available with Seam
P7500	Sheerweave 7500	118	168	Yes

**To determine the maximum width for continuous Fabric Cornices, subtract 4 inches from the maximum non-railroad width.

- Railroad Fabrics (turned width for length) will have a visible seam when fabricated longer than the maximum roll width less 16".
- The **Red Box** in the spec chart indicates shade sizes metal chain is recommended for Continuous Loop Control.

Top Treatment	Legend			
Medium Cassette				
3" Fascia				
Large Cassette				
Square Cassette				
Fabric Cornice				
4" Fascia				
Open Roll				

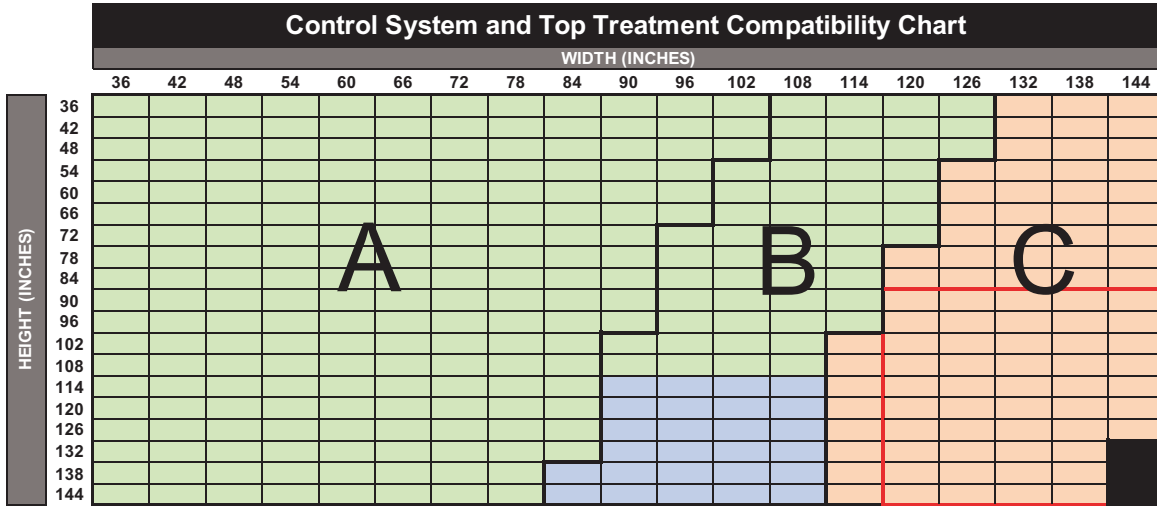

Control Systems (Minimum height for all Control Systems is 12")		Minimum Width (Single Panel)	Overall Minimum Width (2-on-1)	Specification Zone(s)*	Top Treatment
Continuous Loop Control	Continuous Loop Control (Maximum height for 12" width is 60")	12"	24"	A, B & C	All
	**Continuous Loop Control with Spring Assist	60"	NA	A, B & C	Open Roll & 4" Fascia
PowerWand	Powerwand 1.0 Li-Ion	21"	43"	A	All
	Powerwand 2.0 Li-Ion	22"	45"	A & B	(except 3" Fascia)
Lithium-ion Motors	Bliss™ 1.1 Li-Ion	21 1/2"	44"	A	All
	Bliss™ 2.0 Li-Ion	29"	59"	A & B	
	Sonessé® 28 WireFree™ RTS Li-Ion / Sonessé® 28 WireFree™ Zigbee Li-Ion	24 1/2"	50"	A	
	Sonessé® ULTRA 30 WireFree™ RTS Li-Ion	28 1/2"	58"	A & B	
DC Motors	Bliss™ 1.1 DC	16 1/2"	34"	A	All
	Bliss™ 2.0 DC	22 1/2"	46"	A & B	
	Sonessé® 28 WireFree™ RTS DC / Sonessé® 28 WireFree™ Zigbee DC	16 1/2"	34"	A	
	Sonessé® 30 RTS 24v DC	21"	NA	A & B	

**See Spring Assist Section in reference guide for details

*Not all fabrics are available in all zones

Control System and Top Treatment Compatibility Chart - High Torque Motors

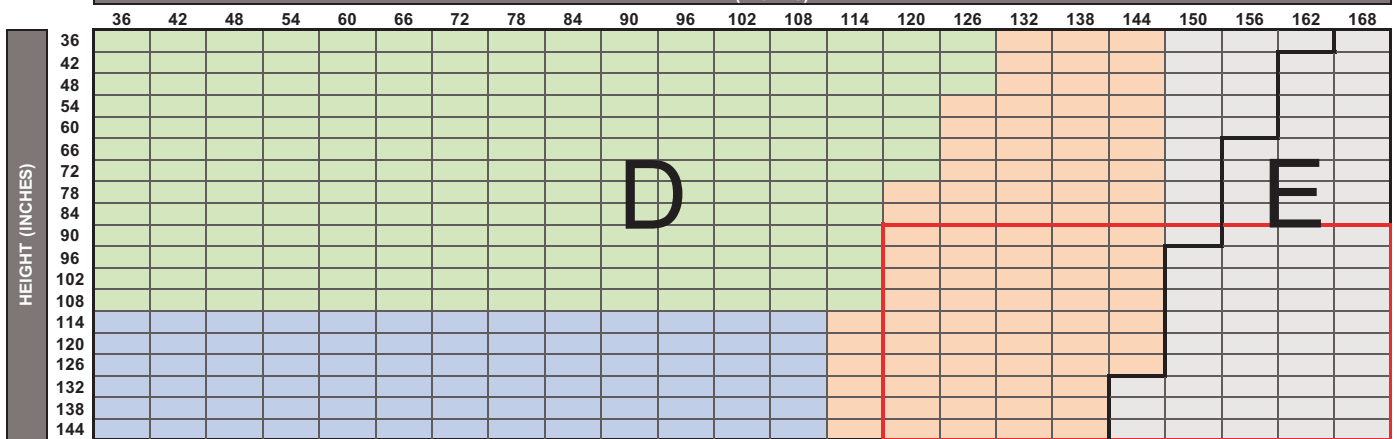

Control Systems (Minimum height for all Control Systems is 12")		Minimum Width (Single Panel)	Overall Minimum Width (2-on-1)	Specification Zone(s)*	Top Treatment
Lithium-ion Motors	Bliss™ 3.0 Li-Ion	32"	65"	D & E	All
	Sonessé® 40 WireFree™ RTS Li-Ion	31"	63"	D	
AC Motors	Bliss™ 10.0 AC	35"	NA	D & E	Open Roll, Fabric Cornice, and 4" Fascia
	Sonessé® 50 RTS AC (120V)	33"	NA	D & E	
	Sonessé® Ultra 50 AC (120V)	39"	NA	D & E	

*Not all fabrics are available in all zones

PRODUCT SIZE SPECIFICATIONS – CONTINUOUS LOOP CONTROL & AUTOMATION

Collection Code	Collection Name	Max Width Non-Railroaded ** (inches)	Max Width Railroaded (inches)	Available with Seam
P7500R	Sheerweave 7500R	118	168	Yes

**To determine the maximum width for continuous Fabric Cornices, subtract 4 inches from the maximum non-railroad width.

• Railroad Fabrics (turned width for length) will have a visible seam when fabricated longer than the maximum roll width less 16".

• Red Box in spec chart indicates shade sizes Heat Sealed Hem Bar is recommended. For Continuous Loop Control, metal chain is also recommended for these sizes.

Top Treatment	Legend			
Medium Cassette				
3" Fascia				
Large Cassette				
Square Cassette				
Fabric Cornice				
4" Fascia				
Open Roll				

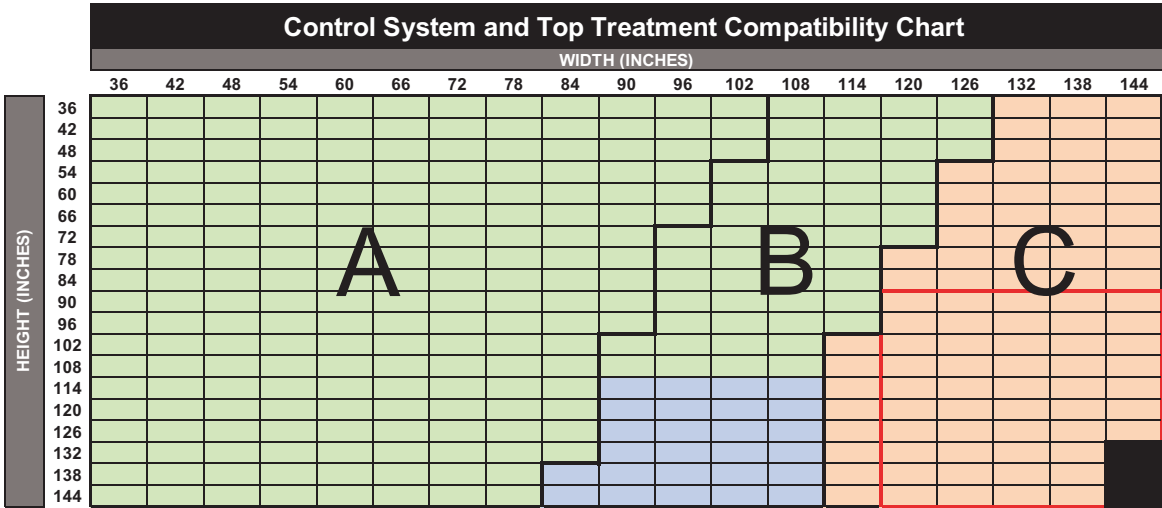

Control Systems (Minimum height for all Control Systems is 12")		Minimum Width (Single Panel)	Overall Minimum Width (2-on-1)	Specification Zone(s)*	Top Treatment
Continuous Loop Control	Continuous Loop Control (Maximum height for 12" width is 60")	12"	24"	A, B & C	All
	**Continuous Loop Control with Spring Assist	60"	NA	A, B & C	Open Roll & 4" Fascia
PowerWand	Powerwand 1.0 Li-Ion	21"	43"	A	All
	Powerwand 2.0 Li-Ion	22"	45"	A & B	(except 3" Fascia)
Lithium-ion Motors	Bliss™ 1.1 Li-Ion	21 1/2"	44"	A	All
	Bliss™ 2.0 Li-Ion	29"	59"	A & B	
	Sonessé® 28 WireFree™ RTS Li-Ion / Sonessé® 28 WireFree™ Zigbee Li-Ion	24 1/2"	50"	A	
	Sonessé® ULTRA 30 WireFree™ RTS Li-Ion	28 1/2"	58"	A & B	
DC Motors	Bliss™ 1.1 DC	16 1/2"	34"	A	All
	Bliss™ 2.0 DC	22 1/2"	46"	A & B	
	Sonessé® 28 WireFree™ RTS DC / Sonessé® 28 WireFree™ Zigbee DC	16 1/2"	34"	A	
	Sonessé® 30 RTS 24v DC	21"	NA	A & B	

**See Spring Assist Section in reference guide for details

*Not all fabrics are available in all zones

Control System and Top Treatment Compatibility Chart - High Torque Motors

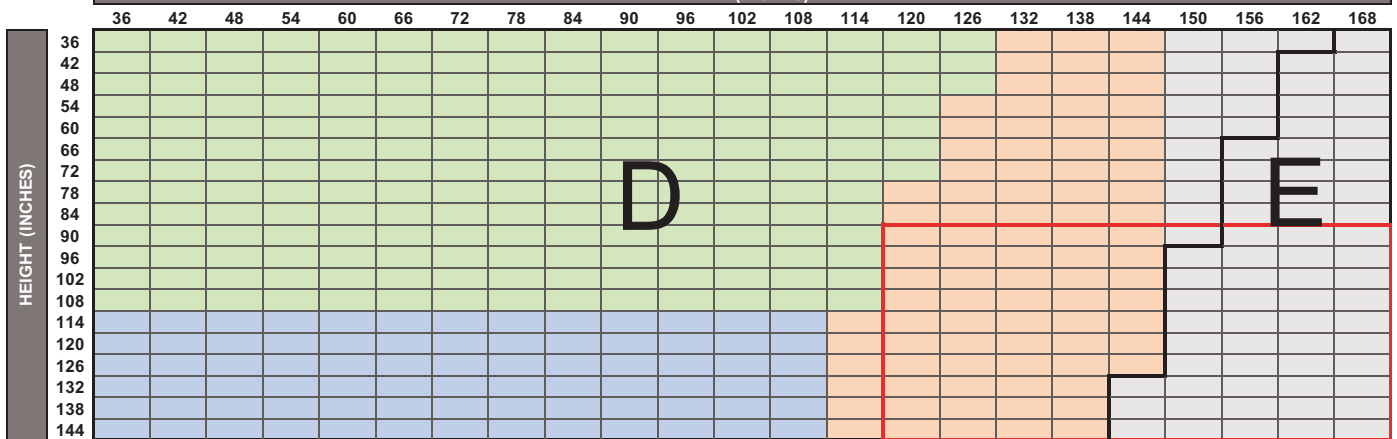

Control Systems (Minimum height for all Control Systems is 12")		Minimum Width (Single Panel)	Overall Minimum Width (2-on-1)	Specification Zone(s)*	Top Treatment
Lithium-ion Motors	Bliss™ 3.0 Li-Ion	32"	65"	D & E	All
	Sonessé® 40 WireFree™ RTS Li-Ion	31"	63"	D	
AC Motors	Bliss™ 10.0 AC	35"	NA	D & E	Open Roll, Fabric Cornice, and 4" Fascia
	Sonessé® 50 RTS AC (120V)	33"	NA	D & E	
	Sonessé® Ultra 50 AC (120V)	39"	NA	D & E	

*Not all fabrics are available in all zones

PRODUCT SIZE SPECIFICATIONS – CONTINUOUS LOOP CONTROL & AUTOMATION

Collection Code	Collection Name	Max Width Non-Railroaded ** (inches)	Max Width Railroaded (inches)	Available with Seam
P7700R	Sheerweave 7700R	118	NA	No

**To determine the maximum width for continuous Fabric Cornices, subtract 4 inches from the maximum non-railroad width.

- Railroad Fabrics (turned width for length) will have a visible seam when fabricated longer than the maximum roll width less 16".
- The **Red Box** in the spec chart indicates shade sizes metal chain is recommended for Continuous Loop Control.

Top Treatment	Legend			
Medium Cassette				
3" Fascia				
Large Cassette				
Square Cassette				
Fabric Cornice				
4" Fascia				
Open Roll				

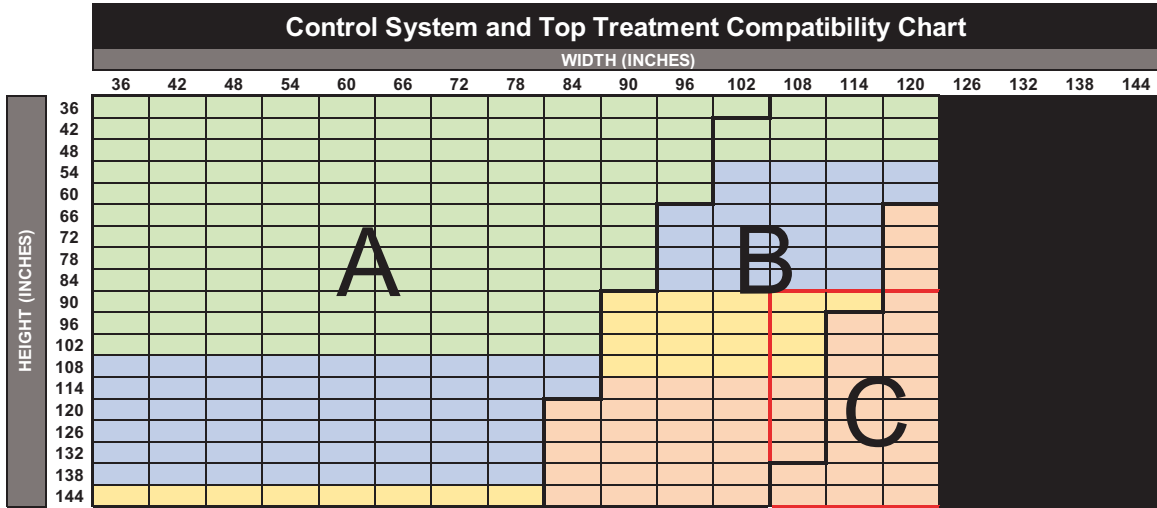

Control Systems (Minimum height for all Control Systems is 12")		Minimum Width (Single Panel)	Overall Minimum Width (2-on-1)	Specification Zone(s)*	Top Treatment
Continuous Loop Control	Continuous Loop Control (Maximum height for 12" width is 60")	12"	24"	A, B & C	All
	**Continuous Loop Control with Spring Assist	60"	NA	A, B & C	Open Roll & 4" Fascia
PowerWand	Powerwand 1.0 Li-Ion	21"	43"	A	All
	Powerwand 2.0 Li-Ion	22"	45"	A & B	(except 3" Fascia)
Lithium-ion Motors	Bliss™ 1.1 Li-Ion	21 1/2"	44"	A	All
	Bliss™ 2.0 Li-Ion	29"	59"	A & B	
	Sonessé® 28 WireFree™ RTS Li-Ion / Sonessé® 28 WireFree™ Zigbee Li-Ion	24 1/2"	50"	A	
	Sonessé® ULTRA 30 WireFree™ RTS Li-Ion	28 1/2"	58"	A & B	
DC Motors	Bliss™ 1.1 DC	16 1/2"	34"	A	All
	Bliss™ 2.0 DC	22 1/2"	46"	A & B	
	Sonessé® 28 WireFree™ RTS DC / Sonessé® 28 WireFree™ Zigbee DC	16 1/2"	34"	A	
	Sonessé® 30 RTS 24v DC	21"	NA	A & B	

**See Spring Assist Section in reference guide for details

*Not all fabrics are available in all zones

Control System and Top Treatment Compatibility Chart - High Torque Motors

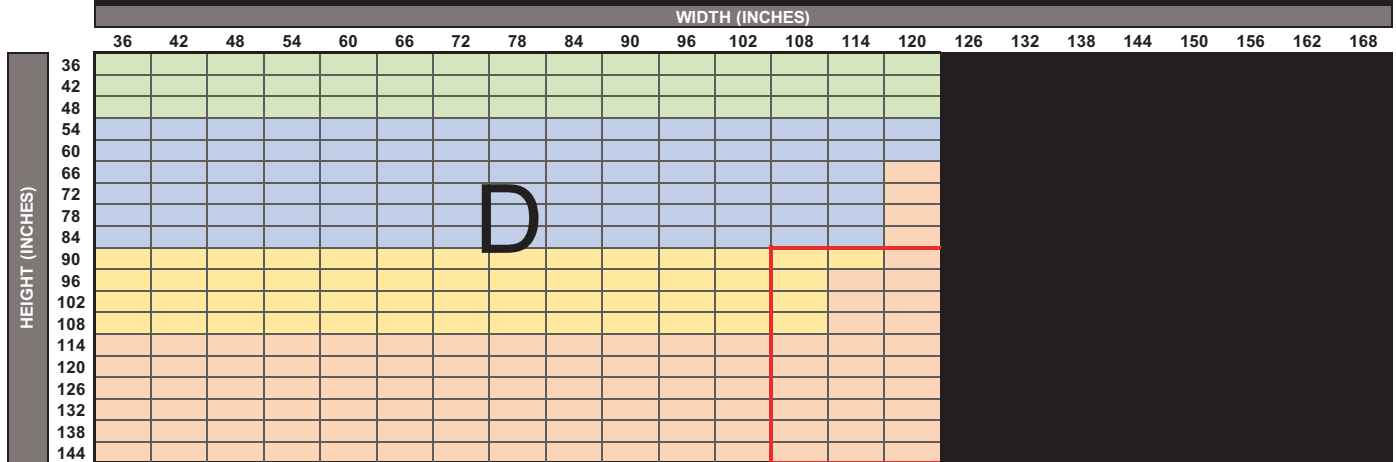

Control Systems (Minimum height for all Control Systems is 12")		Minimum Width (Single Panel)	Overall Minimum Width (2-on-1)	Specification Zone(s)*	Top Treatment
Lithium-ion Motors	Bliss™ 3.0 Li-Ion	32"	65"	D & E	All
	Sonessé® 40 WireFree™ RTS Li-Ion	31"	63"	D	
AC Motors	Bliss™ 10.0 AC	35"	NA	D & E	Open Roll, Fabric Cornice, and 4" Fascia
	Sonessé® 50 RTS AC (120V)	33"	NA	D & E	
	Sonessé® Ultra 50 AC (120V)	39"	NA	D & E	

*Not all fabrics are available in all zones

PRODUCT SIZE SPECIFICATIONS – CONTINUOUS LOOP CONTROL & AUTOMATION

Collection Code	Collection Name	Max Width Non-Railroaded ** (inches)	Max Width Railroaded (inches)	Available with Seam
P7750R	Sheerweave 7750R	118	NA	No

**To determine the maximum width for continuous Fabric Cornices, subtract 4 inches from the maximum non-railroad width.

- Railroad Fabrics (turned width for length) will have a visible seam when fabricated longer than the maximum roll width less 16".
- Red Box in spec chart indicates shade sizes Heat Sealed Hem Bar is recommended. For Continuous Loop Control, metal chain is also recommended for these sizes.

Top Treatment	Legend			
Medium Cassette				
3" Fascia				
Large Cassette				
Square Cassette				
Fabric Cornice				
4" Fascia				
Open Roll				

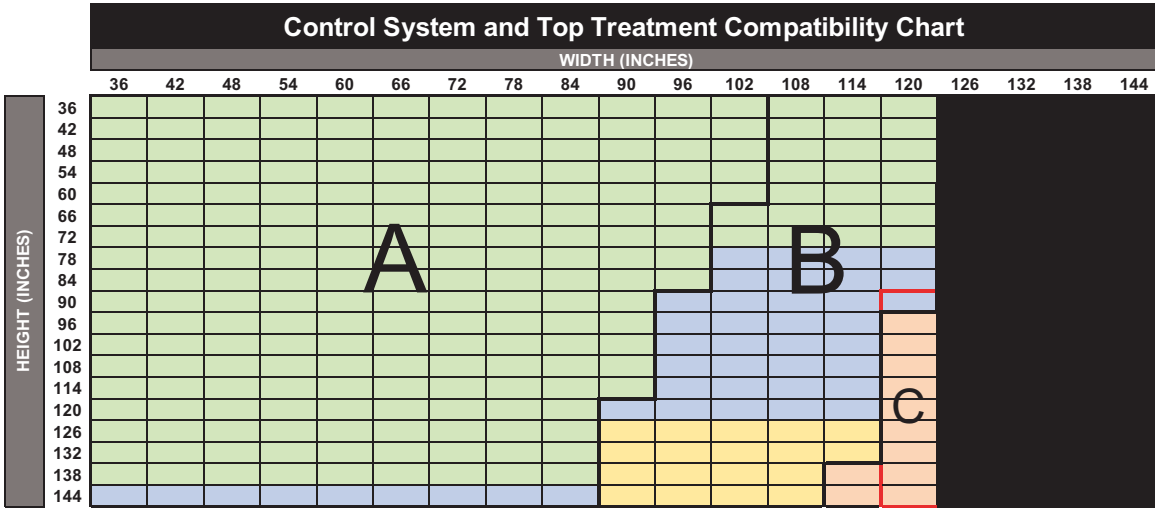

Control Systems (Minimum height for all Control Systems is 12")		Minimum Width (Single Panel)	Overall Minimum Width (2-on-1)	Specification Zone(s)*	Top Treatment
Continuous Loop Control	Continuous Loop Control (Maximum height for 12" width is 60")	12"	24"	A, B & C	All
	**Continuous Loop Control with Spring Assist	60"	NA	A, B & C	Open Roll & 4" Fascia
PowerWand	Powerwand 1.0 Li-Ion	21"	43"	A	All
	Powerwand 2.0 Li-Ion	22"	45"	A & B	(except 3" Fascia)
Lithium-ion Motors	Bliss™ 1.1 Li-Ion	21 1/2"	44"	A	All
	Bliss™ 2.0 Li-Ion	29"	59"	A & B	
	Sonessé® 28 WireFree™ RTS Li-Ion / Sonessé® 28 WireFree™ Zigbee Li-Ion	24 1/2"	50"	A	
	Sonessé® ULTRA 30 WireFree™ RTS Li-Ion	28 1/2"	58"	A & B	
DC Motors	Bliss™ 1.1 DC	16 1/2"	34"	A	All
	Bliss™ 2.0 DC	22 1/2"	46"	A & B	
	Sonessé® 28 WireFree™ RTS DC / Sonessé® 28 WireFree™ Zigbee DC	16 1/2"	34"	A	
	Sonessé® 30 RTS 24v DC	21"	NA	A & B	

**See Spring Assist Section in reference guide for details

*Not all fabrics are available in all zones

Control System and Top Treatment Compatibility Chart - High Torque Motors

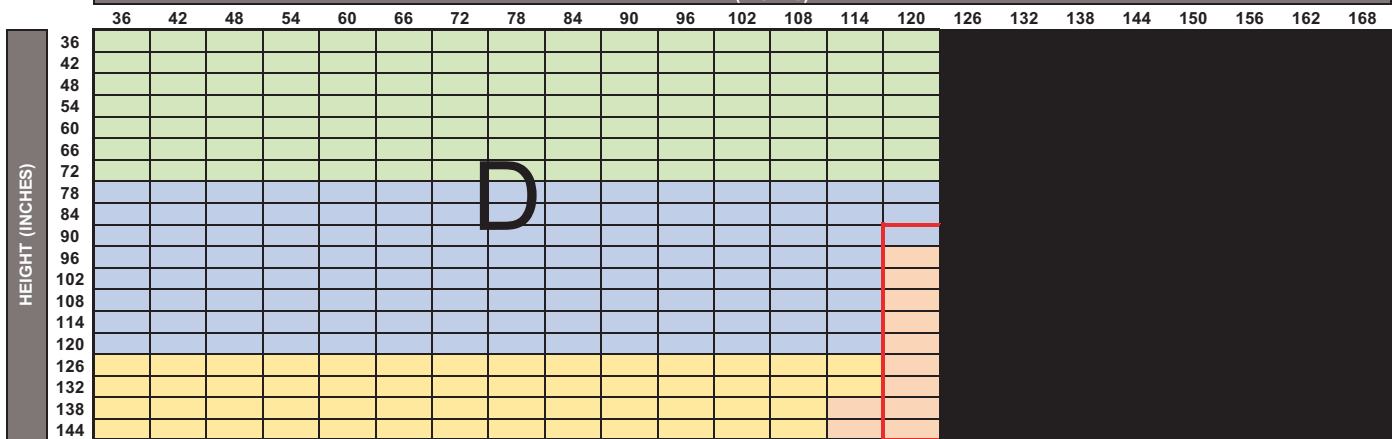

Control Systems (Minimum height for all Control Systems is 12")		Minimum Width (Single Panel)	Overall Minimum Width (2-on-1)	Specification Zone(s)*	Top Treatment
Lithium-ion Motors	Bliss™ 3.0 Li-Ion	32"	65"	D & E	All
	Sonessé® 40 WireFree™ RTS Li-Ion	31"	63"	D	
AC Motors	Bliss™ 10.0 AC	35"	NA	D & E	Open Roll, Fabric Cornice, and 4" Fascia
	Sonessé® 50 RTS AC (120V)	33"	NA	D & E	
	Sonessé® Ultra 50 AC (120V)	39"	NA	D & E	

*Not all fabrics are available in all zones

PRODUCT SIZE SPECIFICATIONS – CONTINUOUS LOOP CONTROL & AUTOMATION

Collection Code	Collection Name	Max Width Non-Railroaded ** (inches)	Max Width Railroaded (inches)	Available with Seam
RF35	Sorrento	108	NA	No

**To determine the maximum width for continuous Fabric Cornices, subtract 4 inches from the maximum non-railroad width.

- Railroad Fabrics (turned width for length) will have a visible seam when fabricated longer than the maximum roll width less 16".
- Red Box in spec chart indicates shade sizes Heat Sealed Hem Bar is recommended. For Continuous Loop Control, metal chain is also recommended for these sizes.

Top Treatment	Legend			
Medium Cassette				
3" Fascia				
Large Cassette				
Square Cassette				
Fabric Cornice				
4" Fascia				
Open Roll				

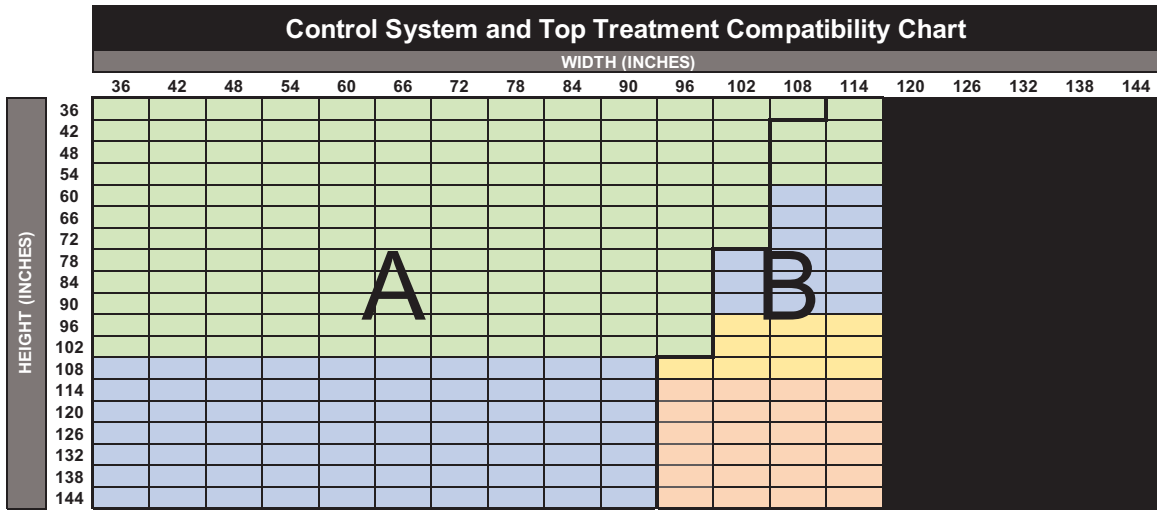

Control Systems (Minimum height for all Control Systems is 12")		Minimum Width (Single Panel)	Overall Minimum Width (2-on-1)	Specification Zone(s)*	Top Treatment
Continuous Loop Control	Continuous Loop Control (Maximum height for 12" width is 60")	12"	24"	A, B & C	All
	**Continuous Loop Control with Spring Assist	60"	NA	A, B & C	Open Roll & 4" Fascia
PowerWand	Powerwand 1.0 Li-Ion	21"	43"	A	All
	Powerwand 2.0 Li-Ion	22"	45"	A & B	(except 3" Fascia)
Lithium-ion Motors	Bliss™ 1.1 Li-Ion	21 1/2"	44"	A	All
	Bliss™ 2.0 Li-Ion	29"	59"	A & B	
	Sonessé® 28 WireFree™ RTS Li-Ion / Sonessé® 28 WireFree™ Zigbee Li-Ion	24 1/2"	50"	A	
	Sonessé® ULTRA 30 WireFree™ RTS Li-Ion	28 1/2"	58"	A & B	
DC Motors	Bliss™ 1.1 DC	16 1/2"	34"	A	All
	Bliss™ 2.0 DC	22 1/2"	46"	A & B	
	Sonessé® 28 WireFree™ RTS DC / Sonessé® 28 WireFree™ Zigbee DC	16 1/2"	34"	A	
	Sonessé® 30 RTS 24v DC	21"	NA	A & B	

**See Spring Assist Section in reference guide for details

*Not all fabrics are available in all zones

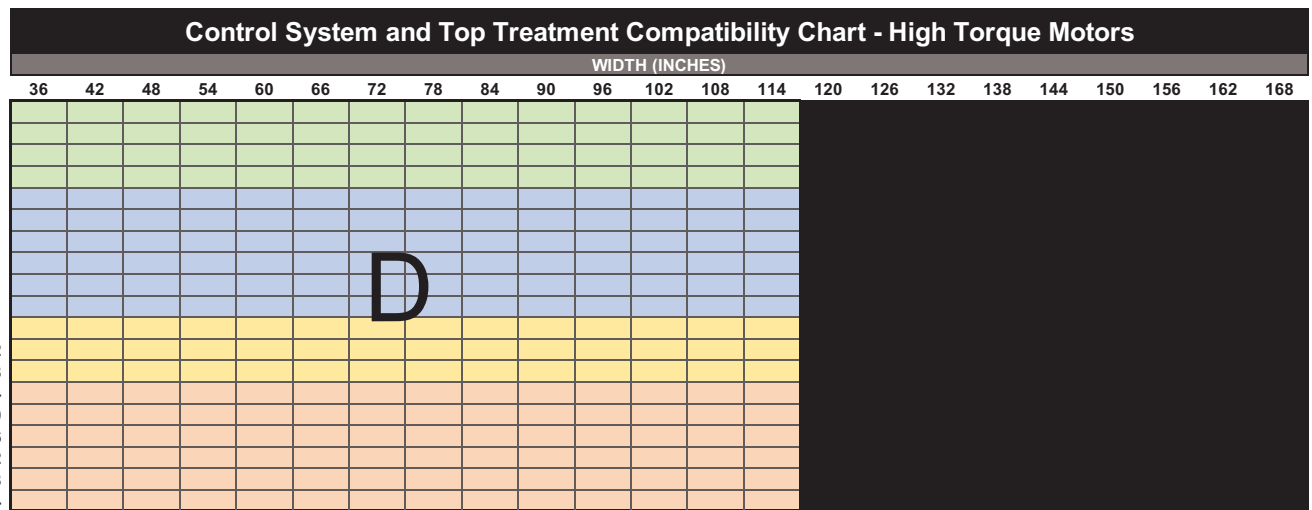

Control Systems (Minimum height for all Control Systems is 12")		Minimum Width (Single Panel)	Overall Minimum Width (2-on-1)	Specification Zone(s)*	Top Treatment
Lithium-ion Motors	Bliss™ 3.0 Li-Ion	32"	65"	D & E	All
	Sonessé® 40 WireFree™ RTS Li-Ion	31"	63"	D	
AC Motors	Bliss™ 10.0 AC	35"	NA	D & E	Open Roll, Fabric Cornice, and 4" Fascia
	Sonessé® 50 RTS AC (120V)	33"	NA	D & E	
	Sonessé® Ultra 50 AC (120V)	39"	NA	D & E	

*Not all fabrics are available in all zones

PRODUCT SIZE SPECIFICATIONS – CONTINUOUS LOOP CONTROL & AUTOMATION

Collection Code	Collection Name	Max Width Non-Railroaded ** (inches)	Max Width Railroaded (inches)	Available with Seam
AF042	Urban	118	168	Yes

**To determine the maximum width for continuous Fabric Cornices, subtract 4 inches from the maximum non-railroad width.

- Railroad Fabrics (turned width for length) will have a visible seam when fabricated longer than the maximum roll width less 16".
- Red Box in spec chart indicates shade sizes Heat Sealed Hem Bar is recommended. For Continuous Loop Control, metal chain is also recommended for these sizes.

Top Treatment	Legend			
Medium Cassette				
3" Fascia				
Large Cassette				
Square Cassette				
Fabric Cornice				
4" Fascia				
Open Roll				

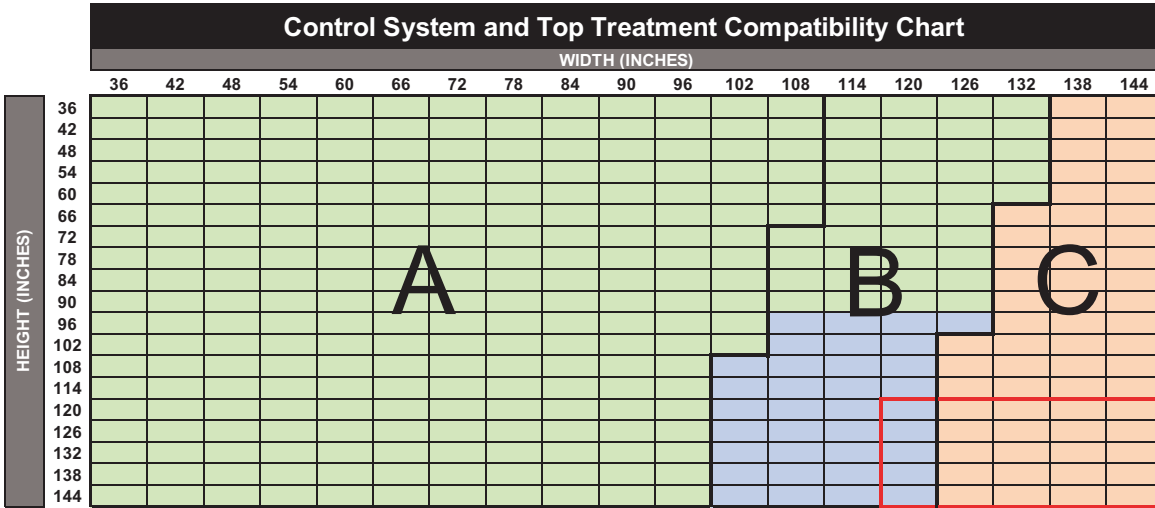

Control Systems (Minimum height for all Control Systems is 12")		Minimum Width (Single Panel)	Overall Minimum Width (2-on-1)	Specification Zone(s)*	Top Treatment
Continuous Loop Control	Continuous Loop Control (Maximum height for 12" width is 60")	12"	24"	A, B & C	All
	**Continuous Loop Control with Spring Assist	60"	NA	A, B & C	Open Roll & 4" Fascia
PowerWand	Powerwand 1.0 Li-Ion	21"	43"	A	All
	Powerwand 2.0 Li-Ion	22"	45"	A & B	(except 3" Fascia)
Lithium-ion Motors	Bliss™ 1.1 Li-Ion	21 1/2"	44"	A	All
	Bliss™ 2.0 Li-Ion	29"	59"	A & B	
	Sonessé® 28 WireFree™ RTS Li-Ion / Sonessé® 28 WireFree™ Zigbee Li-Ion	24 1/2"	50"	A	
	Sonessé® ULTRA 30 WireFree™ RTS Li-Ion	28 1/2"	58"	A & B	
DC Motors	Bliss™ 1.1 DC	16 1/2"	34"	A	All
	Bliss™ 2.0 DC	22 1/2"	46"	A & B	
	Sonessé® 28 WireFree™ RTS DC / Sonessé® 28 WireFree™ Zigbee DC	16 1/2"	34"	A	
	Sonessé® 30 RTS 24v DC	21"	NA	A & B	

**See Spring Assist Section in reference guide for details

*Not all fabrics are available in all zones

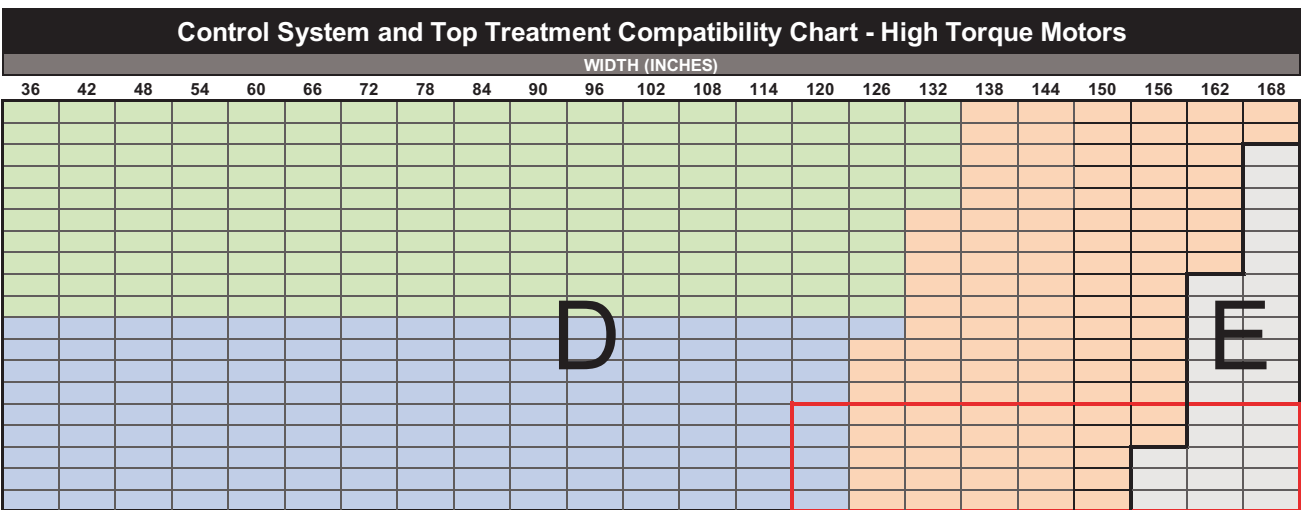

Control Systems (Minimum height for all Control Systems is 12")		Minimum Width (Single Panel)	Overall Minimum Width (2-on-1)	Specification Zone(s)*	Top Treatment
Lithium-ion Motors	Bliss™ 3.0 Li-Ion	32"	65"	D & E	All
	Sonessé® 40 WireFree™ RTS Li-Ion	31"	63"	D	
AC Motors	Bliss™ 10.0 AC	35"	NA	D & E	Open Roll, Fabric Cornice, and 4" Fascia
	Sonessé® 50 RTS AC (120V)	33"	NA	D & E	
	Sonessé® Ultra 50 AC (120V)	39"	NA	D & E	

*Not all fabrics are available in all zones

PRODUCT SIZE SPECIFICATIONS – CONTINUOUS LOOP CONTROL & AUTOMATION

Collection Code	Collection Name	Max Width Non-Railroaded ** (inches)	Max Width Railroaded (inches)	Available with Seam
AR042	Urban Room Darkening	118	168	Yes

**To determine the maximum width for continuous Fabric Cornices, subtract 4 inches from the maximum non-railroad width.

· Railroad Fabrics (turned width for length) will have a visible seam when fabricated longer than the maximum roll width less 16".
 · Red Box in spec chart indicates shade sizes Heat Sealed Hem Bar is recommended. For Continuous Loop Control, metal chain is also recommended for these sizes.

Top Treatment	Legend			
Medium Cassette	Green	Blue	Yellow	Orange
3" Fascia	Green	Blue	Yellow	Orange
Large Cassette	Green	Blue	Yellow	Orange
Square Cassette	Green	Blue	Yellow	Orange
Fabric Cornice	Green	Blue	Yellow	Orange
4" Fascia	Green	Blue	Yellow	Orange
Open Roll	Green	Blue	Yellow	Orange

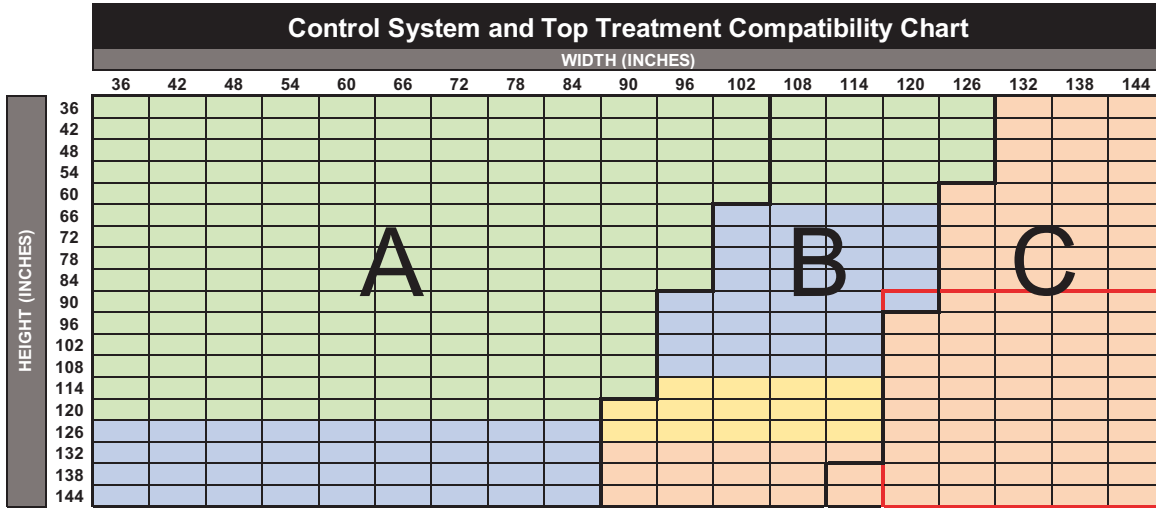

Control Systems (Minimum height for all Control Systems is 12")		Minimum Width (Single Panel)	Overall Minimum Width (2-on-1)	Specification Zone(s)*	Top Treatment
Continuous Loop Control	Continuous Loop Control (Maximum height for 12" width is 60")	12"	24"	A, B & C	All
	**Continuous Loop Control with Spring Assist	60"	NA	A, B & C	Open Roll & 4" Fascia
PowerWand	Powerwand 1.0 Li-Ion	21"	43"	A	All
	Powerwand 2.0 Li-Ion	22"	45"	A & B	(except 3" Fascia)
Lithium-ion Motors	Bliss™ 1.1 Li-Ion	21 1/2"	44"	A	All
	Bliss™ 2.0 Li-Ion	29"	59"	A & B	
	Sonessé® 28 WireFree™ RTS Li-Ion / Sonessé® 28 WireFree™ Zigbee Li-Ion	24 1/2"	50"	A	
	Sonessé® ULTRA 30 WireFree™ RTS Li-Ion	28 1/2"	58"	A & B	
DC Motors	Bliss™ 1.1 DC	16 1/2"	34"	A	All
	Bliss™ 2.0 DC	22 1/2"	46"	A & B	
	Sonessé® 28 WireFree™ RTS DC / Sonessé® 28 WireFree™ Zigbee DC	16 1/2"	34"	A	
	Sonessé® 30 RTS 24v DC	21"	NA	A & B	

**See Spring Assist Section in reference guide for details

*Not all fabrics are available in all zones

Control System and Top Treatment Compatibility Chart - High Torque Motors

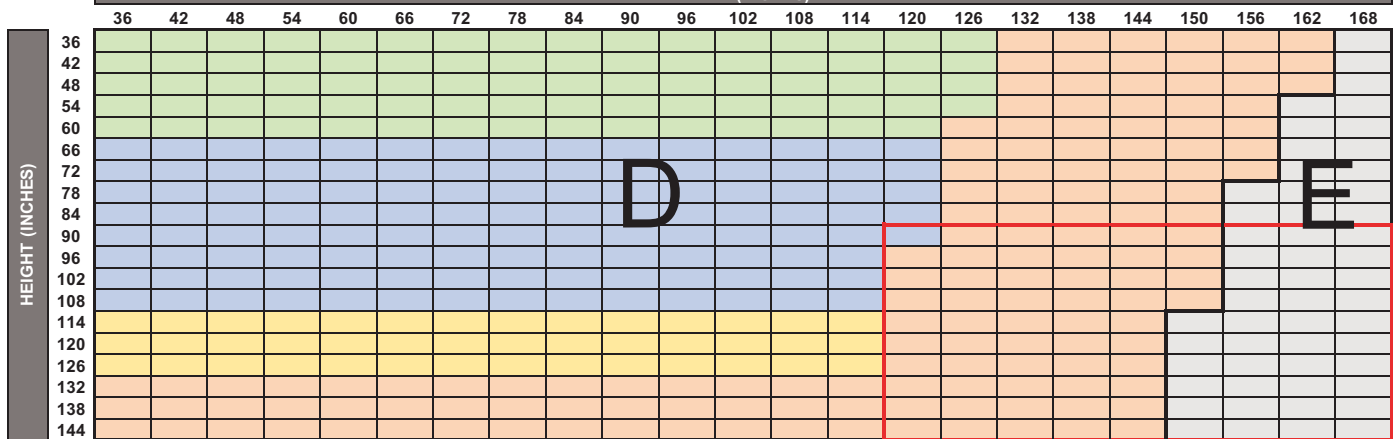

Control Systems (Minimum height for all Control Systems is 12")		Minimum Width (Single Panel)	Overall Minimum Width (2-on-1)	Specification Zone(s)*	Top Treatment
Lithium-ion Motors	Bliss™ 3.0 Li-Ion	32"	65"	D & E	All
	Sonessé® 40 WireFree™ RTS Li-Ion	31"	63"	D	
AC Motors	Bliss™ 10.0 AC	35"	NA	D & E	Open Roll, Fabric Cornice, and 4" Fascia
	Sonessé® 50 RTS AC (120V)	33"	NA	D & E	
	Sonessé® Ultra 50 AC (120V)	39"	NA	D & E	

*Not all fabrics are available in all zones

PRODUCT SIZE SPECIFICATIONS – CONTINUOUS LOOP CONTROL & AUTOMATION

Collection Code	Collection Name	Max Width Non-Railroaded ** (inches)	Max Width Railroaded (inches)	Available with Seam
RD13	Vail	110	NA	No

**To determine the maximum width for continuous Fabric Cornices, subtract 4 inches from the maximum non-railroad width.

- Railroad Fabrics (turned width for length) will have a visible seam when fabricated longer than the maximum roll width less 16".
- Red Box in spec chart indicates shade sizes Heat Sealed Hem Bar is recommended. For Continuous Loop Control, metal chain is also recommended for these sizes.

Top Treatment	Legend			
Medium Cassette				
3" Fascia				
Large Cassette				
Square Cassette				
Fabric Cornice				
4" Fascia				
Open Roll				

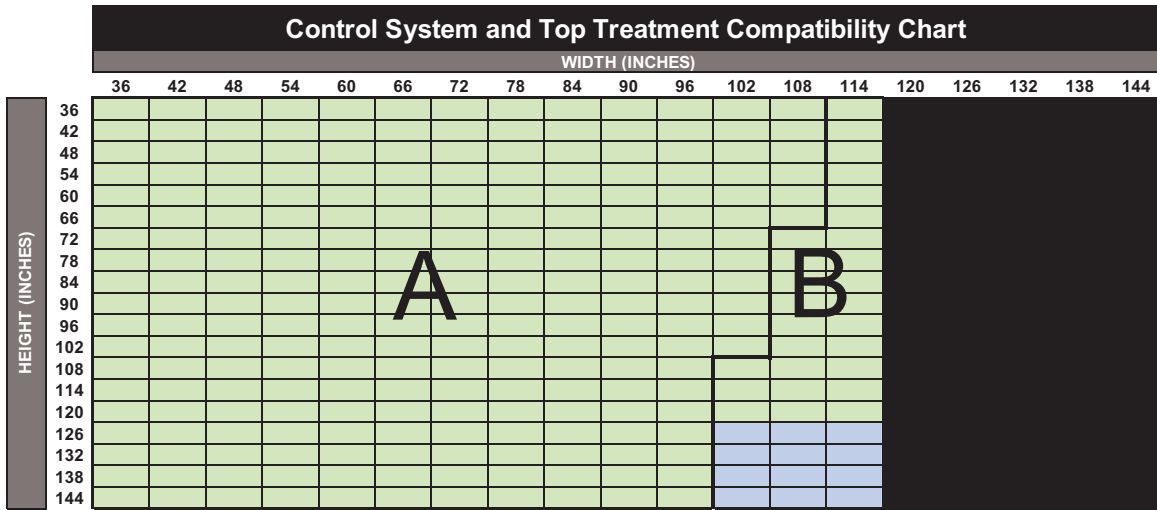

Control Systems (Minimum height for all Control Systems is 12")		Minimum Width (Single Panel)	Overall Minimum Width (2-on-1)	Specification Zone(s)*	Top Treatment
Continuous Loop Control	Continuous Loop Control (Maximum height for 12" width is 60")	12"	24"	A, B & C	All
	**Continuous Loop Control with Spring Assist	60"	NA	A, B & C	Open Roll & 4" Fascia
PowerWand	Powerwand 1.0 Li-Ion	21"	43"	A	All
	Powerwand 2.0 Li-Ion	22"	45"	A & B	(except 3" Fascia)
Lithium-ion Motors	Bliss™ 1.1 Li-Ion	21 1/2"	44"	A	All
	Bliss™ 2.0 Li-Ion	29"	59"	A & B	
	Sonessé® 28 WireFree™ RTS Li-Ion / Sonessé® 28 WireFree™ Zigbee Li-Ion	24 1/2"	50"	A	
	Sonessé® ULTRA 30 WireFree™ RTS Li-Ion	28 1/2"	58"	A & B	
DC Motors	Bliss™ 1.1 DC	16 1/2"	34"	A	All
	Bliss™ 2.0 DC	22 1/2"	46"	A & B	
	Sonessé® 28 WireFree™ RTS DC / Sonessé® 28 WireFree™ Zigbee DC	16 1/2"	34"	A	
	Sonessé® 30 RTS 24v DC	21"	NA	A & B	

**See Spring Assist Section in reference guide for details

*Not all fabrics are available in all zones

Control System and Top Treatment Compatibility Chart - High Torque Motors

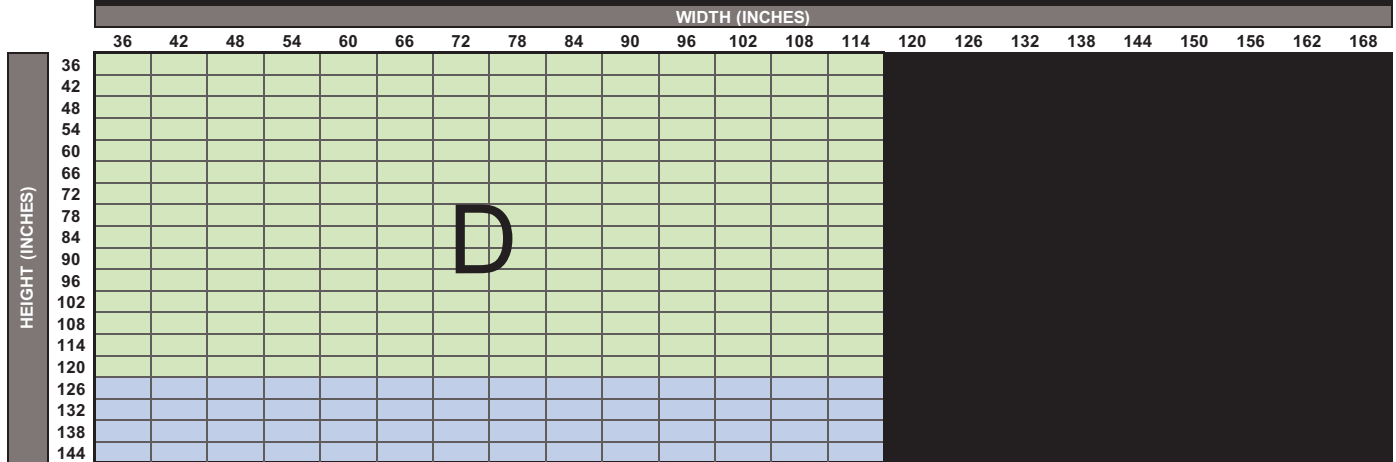

Control Systems (Minimum height for all Control Systems is 12")		Minimum Width (Single Panel)	Overall Minimum Width (2-on-1)	Specification Zone(s)*	Top Treatment
Lithium-ion Motors	Bliss™ 3.0 Li-Ion	32"	65"	D & E	All
	Sonessé® 40 WireFree™ RTS Li-Ion	31"	63"	D	
AC Motors	Bliss™ 10.0 AC	35"	NA	D & E	Open Roll, Fabric Cornice, and 4" Fascia
	Sonessé® 50 RTS AC (120V)	33"	NA	D & E	
	Sonessé® Ultra 50 AC (120V)	39"	NA	D & E	

*Not all fabrics are available in all zones

PRODUCT SIZE SPECIFICATIONS – CONTINUOUS LOOP CONTROL & AUTOMATION

Collection Code	Collection Name	Max Width Non-Railroaded ** (inches)	Max Width Railroaded (inches)	Available with Seam
RB19	Vail Blackout	110	168	Yes

**To determine the maximum width for continuous Fabric Cornices, subtract 4 inches from the maximum non-railroad width.

- Railroad Fabrics (turned width for length) will have a visible seam when fabricated longer than the maximum roll width less 16".
- Red Box in spec chart indicates shade sizes Heat Sealed Hem Bar is recommended. For Continuous Loop Control, metal chain is also recommended for these sizes.

Top Treatment	Legend			
Medium Cassette				
3" Fascia				
Large Cassette				
Square Cassette				
Fabric Cornice				
4" Fascia				
Open Roll				

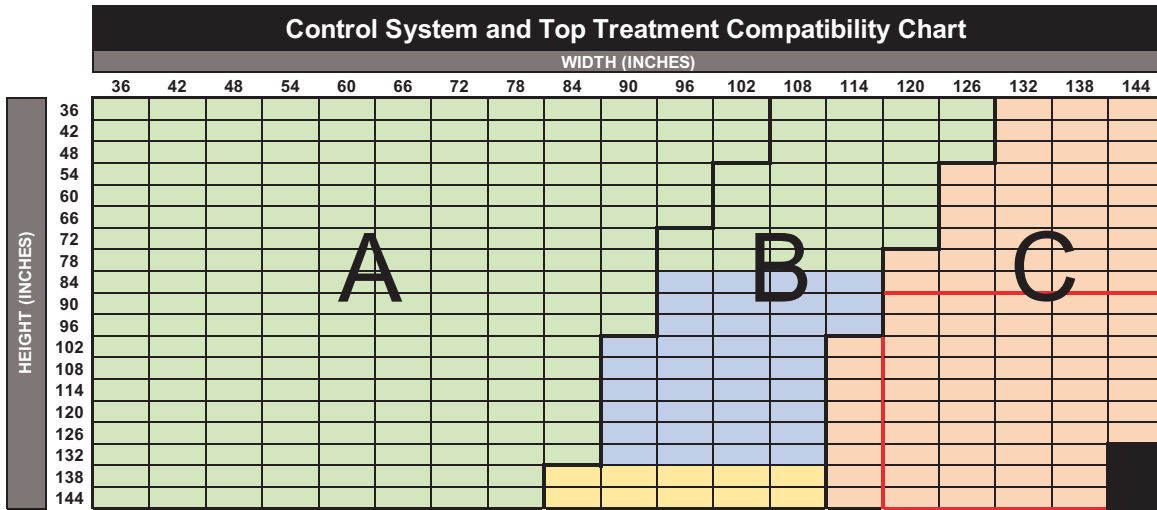

Control Systems (Minimum height for all Control Systems is 12")		Minimum Width (Single Panel)	Overall Minimum Width (2-on-1)	Specification Zone(s)*	Top Treatment
Continuous Loop Control	Continuous Loop Control (Maximum height for 12" width is 60")	12"	24"	A, B & C	All
	**Continuous Loop Control with Spring Assist	60"	NA	A, B & C	Open Roll & 4" Fascia
PowerWand	Powerwand 1.0 Li-Ion	21"	43"	A	All
	Powerwand 2.0 Li-Ion	22"	45"	A & B	(except 3" Fascia)
Lithium-ion Motors	Bliss™ 1.1 Li-Ion	21 1/2"	44"	A	All
	Bliss™ 2.0 Li-Ion	29"	59"	A & B	
	Sonessé® 28 WireFree™ RTS Li-Ion / Sonessé® 28 WireFree™ Zigbee Li-Ion	24 1/2"	50"	A	
	Sonessé® ULTRA 30 WireFree™ RTS Li-Ion	28 1/2"	58"	A & B	
DC Motors	Bliss™ 1.1 DC	16 1/2"	34"	A	All
	Bliss™ 2.0 DC	22 1/2"	46"	A & B	
	Sonessé® 28 WireFree™ RTS DC / Sonessé® 28 WireFree™ Zigbee DC	16 1/2"	34"	A	
	Sonessé® 30 RTS 24v DC	21"	NA	A & B	

**See Spring Assist Section in reference guide for details

*Not all fabrics are available in all zones

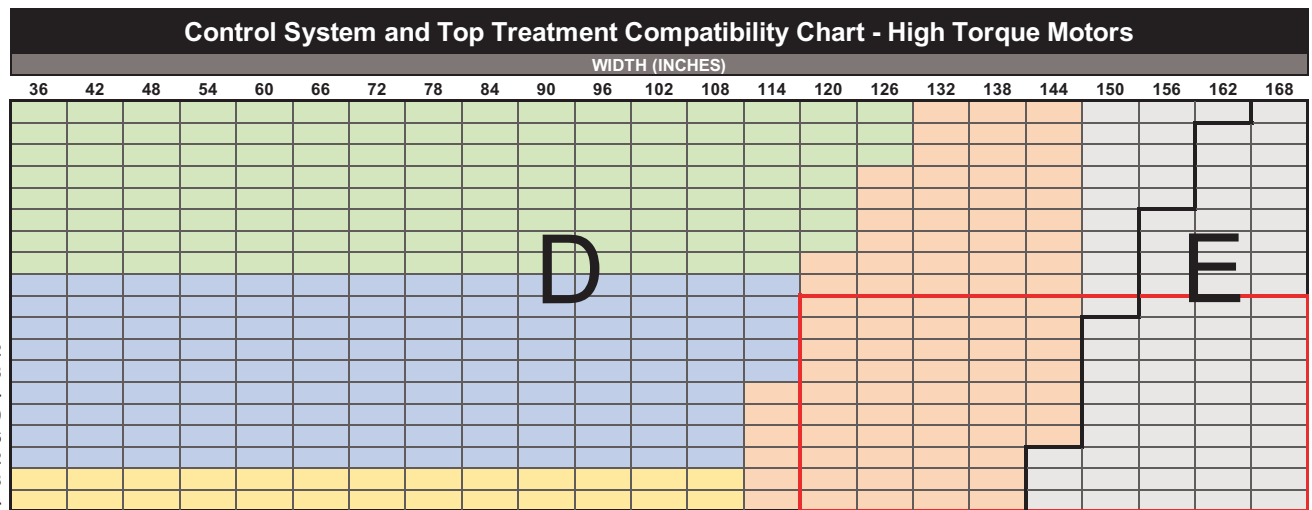

Control Systems (Minimum height for all Control Systems is 12")		Minimum Width (Single Panel)	Overall Minimum Width (2-on-1)	Specification Zone(s)*	Top Treatment
Lithium-ion Motors	Bliss™ 3.0 Li-Ion	32"	65"	D & E	All
	Sonessé® 40 WireFree™ RTS Li-Ion	31"	63"	D	
AC Motors	Bliss™ 10.0 AC	35"	NA	D & E	Open Roll, Fabric Cornice, and 4" Fascia
	Sonessé® 50 RTS AC (120V)	33"	NA	D & E	
	Sonessé® Ultra 50 AC (120V)	39"	NA	D & E	

*Not all fabrics are available in all zones

PRODUCT SIZE SPECIFICATIONS – CONTINUOUS LOOP CONTROL & AUTOMATION

Collection Code	Collection Name	Max Width Non-Railroaded ** (inches)	Max Width Railroaded (inches)	Available with Seam
AF023	York	118	NA	No

**To determine the maximum width for continuous Fabric Cornices, subtract 4 inches from the maximum non-railroad width.

- Railroad Fabrics (turned width for length) will have a visible seam when fabricated longer than the maximum roll width less 16".
- Red Box in spec chart indicates shade sizes Heat Sealed Hem Bar is recommended. For Continuous Loop Control, metal chain is also recommended for these sizes.

Top Treatment	Legend				
Medium Cassette					
3" Fascia					
Large Cassette					
Square Cassette					
Fabric Cornice					
4" Fascia					
Open Roll					

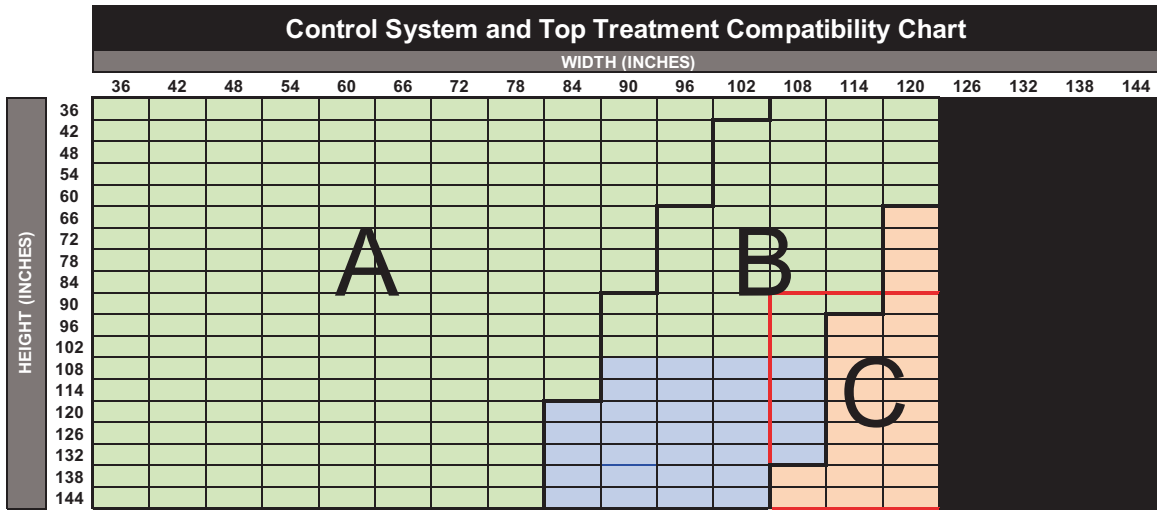

Control Systems (Minimum height for all Control Systems is 12")		Minimum Width (Single Panel)	Overall Minimum Width (2-on-1)	Specification Zone(s)*	Top Treatment
Continuous Loop Control	Continuous Loop Control (Maximum height for 12" width is 60")	12"	24"	A, B & C	All
	**Continuous Loop Control with Spring Assist	60"	NA	A, B & C	Open Roll & 4" Fascia
PowerWand	Powerwand 1.0 Li-Ion	21"	43"	A	All
	Powerwand 2.0 Li-Ion	22"	45"	A & B	(except 3" Fascia)
Lithium-ion Motors	Bliss™ 1.1 Li-Ion	21 1/2"	44"	A	All
	Bliss™ 2.0 Li-Ion	29"	59"	A & B	
	Sonessé® 28 WireFree™ RTS Li-Ion / Sonessé® 28 WireFree™ Zigbee Li-Ion	24 1/2"	50"	A	
	Sonessé® ULTRA 30 WireFree™ RTS Li-Ion	28 1/2"	58"	A & B	
DC Motors	Bliss™ 1.1 DC	16 1/2"	34"	A	All
	Bliss™ 2.0 DC	22 1/2"	46"	A & B	
	Sonessé® 28 WireFree™ RTS DC / Sonessé® 28 WireFree™ Zigbee DC	16 1/2"	34"	A	
	Sonessé® 30 RTS 24v DC	21"	NA	A & B	

**See Spring Assist Section in reference guide for details

*Not all fabrics are available in all zones

Control System and Top Treatment Compatibility Chart - High Torque Motors

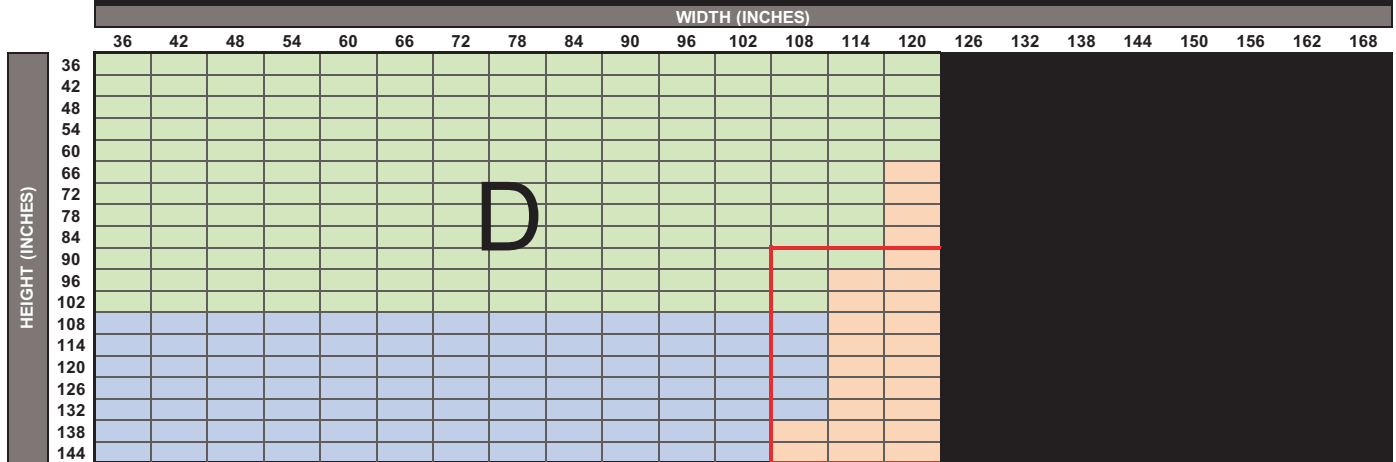

Control Systems (Minimum height for all Control Systems is 12")		Minimum Width (Single Panel)	Overall Minimum Width (2-on-1)	Specification Zone(s)*	Top Treatment
Lithium-ion Motors	Bliss™ 3.0 Li-Ion	32"	65"	D & E	All
	Sonessé® 40 WireFree™ RTS Li-Ion	31"	63"	D	
AC Motors	Bliss™ 10.0 AC	35"	NA	D & E	Open Roll, Fabric Cornice, and 4" Fascia
	Sonessé® 50 RTS AC (120V)	33"	NA	D & E	
	Sonessé® Ultra 50 AC (120V)	39"	NA	D & E	

*Not all fabrics are available in all zones

PRODUCT SIZE SPECIFICATIONS – CONTINUOUS LOOP CONTROL & AUTOMATION

Collection Code	Collection Name	Max Width Non-Railroaded ** (inches)	Max Width Railroaded (inches)	Available with Seam
AB004	ZEN Blackout	78 3/4	NA	No

**To determine the maximum width for continuous Fabric Cornices, subtract 4 inches from the maximum non-railroad width.

- Railroad Fabrics (turned width for length) will have a visible seam when fabricated longer than the maximum roll width less 16".
- Red Box in spec chart indicates shade sizes Heat Sealed Hem Bar is recommended. For Continuous Loop Control, metal chain is also recommended for these sizes.

Top Treatment	Legend			
Medium Cassette				
3" Fascia				
Large Cassette				
Square Cassette				
Fabric Cornice				
4" Fascia				
Open Roll				

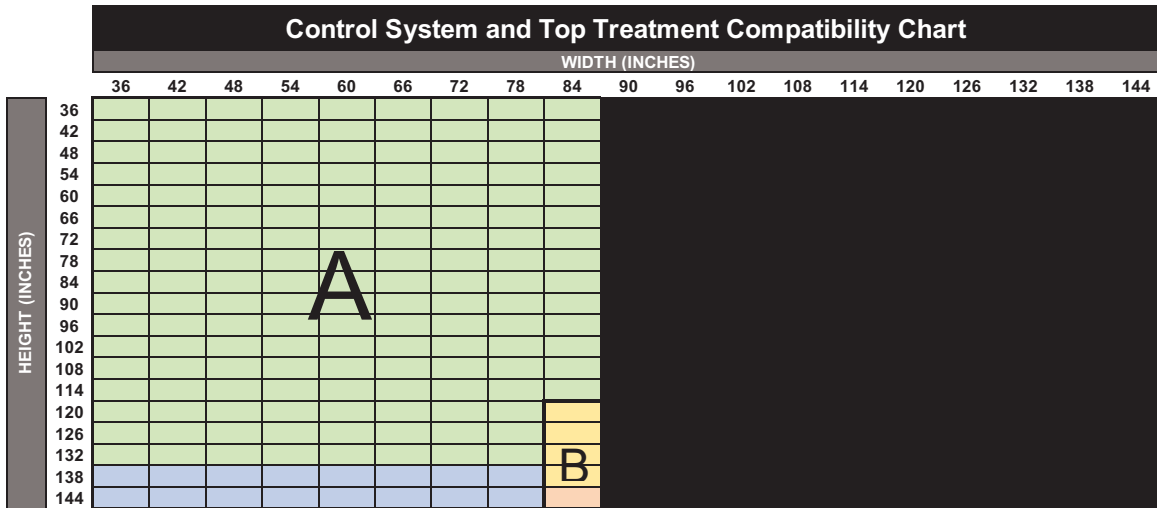

Control Systems (Minimum height for all Control Systems is 12")		Minimum Width (Single Panel)	Overall Minimum Width (2-on-1)	Specification Zone(s)*	Top Treatment
Continuous Loop Control	Continuous Loop Control (Maximum height for 12" width is 60")	12"	24"	A, B & C	All
	**Continuous Loop Control with Spring Assist	60"	NA	A, B & C	Open Roll & 4" Fascia
PowerWand	Powerwand 1.0 Li-Ion	21"	43"	A	All
	Powerwand 2.0 Li-Ion	22"	45"	A & B	(except 3" Fascia)
Lithium-ion Motors	Bliss™ 1.1 Li-Ion	21 1/2"	44"	A	All
	Bliss™ 2.0 Li-Ion	29"	59"	A & B	
	Sonessé® 28 WireFree™ RTS Li-Ion / Sonessé® 28 WireFree™ Zigbee Li-Ion	24 1/2"	50"	A	
	Sonessé® ULTRA 30 WireFree™ RTS Li-Ion	28 1/2"	58"	A & B	
DC Motors	Bliss™ 1.1 DC	16 1/2"	34"	A	All
	Bliss™ 2.0 DC	22 1/2"	46"	A & B	
	Sonessé® 28 WireFree™ RTS DC / Sonessé® 28 WireFree™ Zigbee DC	16 1/2"	34"	A	
	Sonessé® 30 RTS 24v DC	21"	NA	A & B	

**See Spring Assist Section in reference guide for details

*Not all fabrics are available in all zones

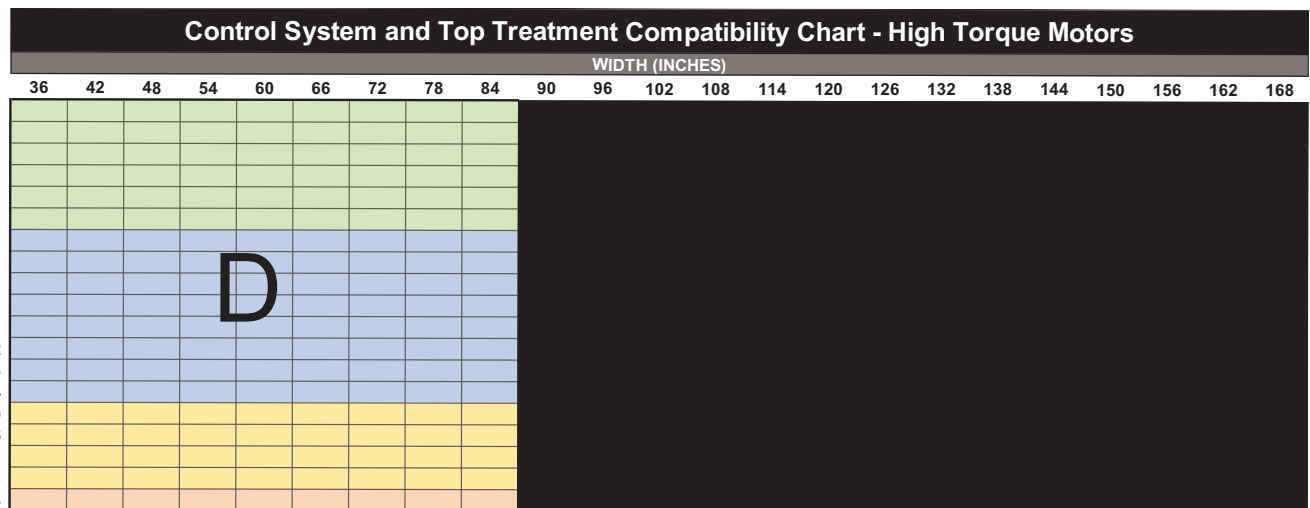

Control Systems (Minimum height for all Control Systems is 12")		Minimum Width (Single Panel)	Overall Minimum Width (2-on-1)	Specification Zone(s)*	Top Treatment
Lithium-ion Motors	Bliss™ 3.0 Li-Ion	32"	65"	D & E	All
	Sonessé® 40 WireFree™ RTS Li-Ion	31"	63"	D	
AC Motors	Bliss™ 10.0 AC	35"	NA	D & E	Open Roll, Fabric Cornice, and 4" Fascia
	Sonessé® 50 RTS AC (120V)	33"	NA	D & E	
	Sonessé® Ultra 50 AC (120V)	39"	NA	D & E	

*Not all fabrics are available in all zones

Collection Code	Collection Name	Cordless Lift Spec Chart
R80	1% E Screen	K
AS010	1% EnduroScreen	Q
AS013	1% Environs Screen	F
RS23	1% Nordic Screen Plus	O
RS7	1% S Screen	T
R01	1% Sheerweave 2500	O
RS21	1% Sheerweave 2701	M
P4001	1% Sheerweave 4001	U
P4901	1% Sheerweave 4901	O
P5001	1% Sheerweave 5000	R
AS028	3% Bamboo	M
AS024	3% Bellflower	M
AS026	3% Delhi	M
R81	3% E Screen	H
AS008	3% Ecoscope Screen	D
AS011	3% EnduroScreen	O
AS014	3% Environs Screen	F
AS027	3% Lady Amherst	M
RS24	3% Nordic Screen Plus	M
R06	3% Sheerweave 2410	K
P2703	3% Sheerweave 2703	K
RS2	3% Sheerweave 4400	T
P4600	3% Sheerweave 4600	Q
P4903	3% Sheerweave 4903	M
R07	3% Sheerweave 5000	P
AS029	3% Sovereign	M
AS006	3% Tweed Screen	K
RS15	4% S Screen	T
R51	5% E Screen	G
AS009	5% Ecoscope Screen	C
AS012	5% EnduroScreen	M
AS015	5% Environs Screen	E
R61	5% M Screen Deco	H
RS25	5% Nordic Screen Plus	K
P2000	5% Sheerweave 2000	K
RS1	5% Sheerweave 2390	H
P2705	5% Sheerweave 2705	I
R09	5% Sheerweave 4000	S
P4500	5% Sheerweave 4500	K
R10	5% Sheerweave 5000	L
AS007	5% Spectra Screen	I
AS005	5% Willow Screen	I
R34	7% Sheerweave 5000	L
R19	10% E Screen	G
P2360	10% Sheerweave 2360	F
P4100	10% Sheerweave 4100	Q
R26	10% Sheerweave 5000	L

Collection Code	Collection Name	Cordless Lift Spec Chart
AF034	Adelaide	B
AB034	Adelaide Blackout	I
AF016	Aegean	D
AF030	Alpine	D
AB030	Alpine Blackout	J
AF020	Aqua-Tex	C
AB020	Aqua-Tex Blackout	G
AF035	Arches	A
AB035	Arches Blackout	E
AB022	Aries Blackout	D
AF019	Baltic	C
AB019	Baltic Blackout	I
AF028	Bamboo	A
AB028	Bamboo Blackout	F

Collection Code	Collection Name	Cordless Lift Spec Chart
AF024	Bellflower	A
AB024	Bellflower Blackout	E
R40	Blackout - Solid	H
AF031	Bonn	C
RD8	Brilliance	C
RB6	Brilliance Blackout	I
AF040	Burton	A
RD6	Carrara	C
RB4	Carrara Blackout	J
RB16	Chesapeake Blackout	G
RD7	Claudio	B
RB5	Claudio Blackout	I
AB021	Cusco Blackout	G
AF026	Delhi	K
AB026	Delhi Blackout	K
RD2	Drizzle	C
AF037	Fuji	E
AF025	Heritage	C
AB025	Heritage Blackout	K
AB036	Horizon Blackout	H
AF018	Juniper	G
AB018	Juniper Blackout	M
AF027	Lady Amherst	A
AB027	Lady Amherst Blackout	F
AF033	Lavish	B
R56	Linview	A
RB3	Linview Blackout	F
RF4	Montero	E
AR041	Opulence Room Darkening	G
AF032	Pacific	B
AB032	Pacific Blackout	G
AF017	Queenland	A
AB017	Queenland Blackout	H
RD21	Ranger	C
RB13	Ranger Blackout	K
AF038	Rhine	A
RF3	Santa Cruz	E
RB1	Santa Cruz Blackout	K
R100	Scala Blackout	G
AF039	Sequoia	A
R11	Sheerweave 7000	I
P7200R	Sheerweave 7200R	G
P7250R	Sheerweave 7250R	B
P7400	Sheerweave 7400	J
P7450	Sheerweave 7450	C
P7500	Sheerweave 7500	H
P7500R	Sheerweave 7500R	G
P7700R	Sheerweave 7700R	K
P7750R	Sheerweave 7750R	E
RF35	Sorrento	C
AF042	Urban	B
AR042	URBAN Room Darkening	D
RD13	Vail	A
RB19	Vail Blackout	G
AF023	York	B
AB004	ZEN Blackout	J

PRODUCT SIZE SPECIFICATIONS – CORDLESS LIFT

Fabric Group: A

Fabric Code	Material Name	Max Width Non-Railroaded	Max Width Railroaded	Available with Seam
RD13	Vail	108	NA	
AF038	Rhine	108	NA	
AF039	Sequoia	108	108	Yes
AF040	Burton	108	NA	
R56	Linview	108	108	Yes
AF027	Lady Amherst	108	NA	
AF024	Bellflower	108	NA	
AF028	Bamboo	108	NA	
AF035	Arches	108	NA	
AF017	Queenland	108	NA	

Top Treatment	Legend	
Medium Cassette		
3" Fascia		
Large Cassette		
Square Cassette		
Fabric Cornice		
4" Fascia		
Open Roll		

Fabric Group: A

Shade size (in)	36	42	48	54	60	66	72	78	84	90	96	102	108
36													
42													
48													
54													
60													
66													
72													
78													
84													
90													
96													
102													
108													
114													
120													

Control System	***Minimum Width (Single Panel)	***Overall Minimum Width (2 on 1)	Minimum Height	Top Treatment
Cordless Lift	18"	NA	24"	All

PRODUCT SIZE SPECIFICATIONS – CORDLESS LIFT

Fabric Group: B

Fabric Code	Material Name	Max Width Non-Railroaded	Max Width Railroaded	Available with Seam
AF023	York	108	NA	
AF042	Urban	108	108	Yes
AF034	Adelaide	108	NA	
AF033	Lavish	108	NA	
RD7	Claudio	108	NA	
P7250R	Sheerweave 7250R	108	NA	
AF032	Pacific	108	NA	

Top Treatment	Legend	
Medium Cassette		
3" Fascia		
Large Cassette		
Square Cassette		
Fabric Cornice		
4" Fascia		
Open Roll		

Fabric Group: B

Shade size (in)	36	42	48	54	60	66	72	78	84	90	96	102	108
36													
42													
48													
54													
60													
66													
72													
78													
84													
90													
96													
102													
108													
114													
120													

Control SyStem	***Minimium Width (Single Panel)	***Overall Minimium Width (2 on 1)	Minimum Height	Top Treatment
Cordless Lift	18"	NA	24"	All

PRODUCT SIZE SPECIFICATIONS – CORDLESS LIFT

Fabric Group: C

Fabric Code	Material Name	Max Width Non-Railroaded	Max Width Railroaded	Available with Seam
P7450	Sheerweave 7450	108	NA	
RD6	Carrara	108	NA	
RD8	Brilliance	108	NA	
RD2	Drizzle	94 1/2**	108	Yes
RF35	Sorrento	108	NA	
RD21	Ranger	108	NA	
AF019	Baltic	108	NA	
AF031	Bonn	98**	108	Yes
AF020	Aqua-Tex	108	NA	
AS009	5% Ecoscape Screen	108	NA	
AF026	Delhi	105	NA	
AF025	Heritage	105	NA	

**To determine the maximum width for continuous Fabric Cornices, subtract 4 inches from the maximum non-railroad width.

Top Treatment	Legend	
Medium Cassette		
3" Fascia		
Large Cassette		
Square Cassette		
Fabric Cornice		
4" Fascia		
Open Roll		

Fabric Group: C

Shade size (in)	36	42	48	54	60	66	72	78	84	90	96	102	108
36													
42													
48													
54													
60													
66													
72													
78													
84													
90													
96													
102													
108													
114													
120													

Control SyStem	***Minimum Width (Single Panel)	***Overall Minimum Width (2 on 1)	Minimum Height	Top Treatment
Cordless Lift	18"	NA	24"	All

PRODUCT SIZE SPECIFICATIONS – CORDLESS LIFT

Fabric Group: D

Fabric Code	Material Name	Max Width Non-Railroaded	Max Width Railroaded	Available with Seam
AS008	3% Ecoscape Screen	108	NA	
AR042	Urban Room Darkening	108	108	Yes
AF030	Alpine	108	108	Yes
AF016	Aegean	78 3/4**	NA	
AB022	Aries Blackout	108	NA	

**To determine the maximum width for continuous Fabric Cornices, subtract 4 inches from the maximum non-railroad width.

Top Treatment	Legend	
Medium Cassette		
3" Fascia		
Large Cassette		
Square Cassette		
Fabric Cornice		
4" Fascia		
Open Roll		

Fabric Group: D

Shade size (in)	36	42	48	54	60	66	72	78	84	90	96	102	108
36													
42													
48													
54													
60													
66													
72													
78													
84													
90													
96													
102													
108													
114													
120													

Control SyStem	***Minium Width (Single Panel)	***Overall Minimum Width (2 on 1)	Minimum Height	Top Treatment
Cordless Lift	18"	NA	24"	All

PRODUCT SIZE SPECIFICATIONS – CORDLESS LIFT

Fabric Group: E

Fabric Code	Material Name	Max Width Non-Railroaded	Max Width Railroaded	Available with Seam
P7750R	Sheerweave 7750R	108	NA	
AF037	Fuji	78 3/4**	108	Yes
RF3	Santa Cruz	94**	NA	
RF4	Montero	94**	NA	
AB035	Arches Blackout	108	NA	
AB024	Bellflower Blackout	108	NA	
AS015	5% Environs Screen	108	108*	Yes

**To determine the maximum width for continuous Fabric Cornices, subtract 4 inches from the maximum non-railroad width.

Top Treatment	Legend	
Medium Cassette		
3" Fascia		
Large Cassette		
Square Cassette		
Fabric Cornice		
4" Fascia		
Open Roll		

Fabric Group: E

Shade size (in)	36	42	48	54	60	66	72	78	84	90	96	102	108
36													
42													
48													
54													
60													
66													
72													
78													
84													
90													
96													
102													
108													
114													
120													

Control System	***Minimum Width (Single Panel)	***Overall Minimum Width (2 on 1)	Minimum Height	Top Treatment
Cordless Lift	18"	NA	24"	All

PRODUCT SIZE SPECIFICATIONS – CORDLESS LIFT

Fabric Group: F

Fabric Code	Material Name	Max Width Non-Railroaded	Max Width Railroaded	Available with Seam
RB3	Linview Blackout	108	108	Yes
AB027	Lady Amherst Blackout	108	NA	Yes
AB028	Bamboo Blackout	108	NA	Yes
AS014	3% Environs Screen	108	108*	Yes
P2360	10% Sheerweave 2360	108	108	
AS013	1% Environs Screen	108	108*	Yes

*Maximum height is 102" when Railroad

Top Treatment	Legend	
Medium Cassette		
3" Fascia		
Large Cassette		
Square Cassette		
Fabric Cornice		
4" Fascia		
Open Roll		

Fabric Group: F

Shade size (in)	36	42	48	54	60	66	72	78	84	90	96	102	108
36													
42													
48													
54													
60													
66													
72													
78													
84													
90													
96													
102													
108													
114													
120													

Control System	***Minimum Width (Single Panel)	***Overall Minimum Width (2 on 1)	Minimum Height	Top Treatment
Cordless Lift	18"	NA	24"	All

PRODUCT SIZE SPECIFICATIONS – CORDLESS LIFT

Fabric Group: G

Fabric Code	Material Name	Max Width Non-Railroaded	Max Width Railroaded	Available with Seam
AB020	AquaTex Blackout	102	NA	
AR041	Opulence Room Darkening	78 3/4**	NA	
AB032	Pacific Blackout	102	NA	
P7500R	Sheerweave 7500R	102	102	Yes
R19	10% E Screen	102	102	Yes
RB16	Chesapeake Blackout	94**	NA	
P7200R	Sheerweave 7200R	102	NA	
AB021	Cusco Blackout	102	NA	
R51	5% E Screen	102	102	Yes
RB19	Vail Blackout	102	102	Yes
AF018	Juniper	102	102	Yes
R100	Scala Blackout	102	102	Yes

**To determine the maximum width for continuous Fabric Cornices, subtract 4 inches from the maximum non-railroad width.

Top Treatment	Legend	
Medium Cassette		
3" Fascia		
Large Cassette		
Square Cassette		
Fabric Cornice		
4" Fascia		
Open Roll		

Fabric Group: G

Shade size (in)	36	42	48	54	60	66	72	78	84	90	96	102
36												
42												
48												
54												
60												
66												
72												
78												
84												
90												
96												
102												
108												
114												
120												

Control SyStem	***Minimum Width (Single Panel)	***Overall Minimum Width (2 on 1)	Minimum Height	Top Treatment
Cordless Lift	18"	NA	24"	All

PRODUCT SIZE SPECIFICATIONS – CORDLESS LIFT

Fabric Group: H

Fabric Code	Material Name	Max Width Non-Railroaded	Max Width Railroaded	Available with Seam
R61	5% M Screen Deco	98**	102	Yes
AB017	Queenland Blackout	102	NA	
R81	3% E Screen	102	102	
AB036	Horizon Blackout	102	NA	Yes
RS1	5% Sheerweave 2390	102	102	Yes
P7500	Sheerweave 7500	102	102	Yes
R40	Blackout - Solid	72**	102	Yes

**To determine the maximum width for continuous Fabric Cornices, subtract 4 inches from the maximum non-railroad width.

Top Treatment	Legend	
Medium Cassette		
3" Fascia		
Large Cassette		
Square Cassette		
Fabric Cornice		
4" Fascia		
Open Roll		

Fabric Group: H

Shade size (in)	36	42	48	54	60	66	72	78	84	90	96	102
36												
42												
48												
54												
60												
66												
72												
78												
84												
90												
96												
102												
108												
114												
120												

Control System	***Minimum Width (Single Panel)	***Overall Minimum Width (2 on 1)	Minimum Height	Top Treatment
Cordless Lift	18"	NA	24"	All

PRODUCT SIZE SPECIFICATIONS – CORDLESS LIFT

Fabric Group: I

Fabric Code	Material Name	Max Width Non-Railroaded	Max Width Railroaded	Available with Seam
AB034	Adelaide Blackout	102	NA	
R11	Sheerweave 7000	102	102	Yes
AB019	Baltic Blackout	102	NA	
P2705	5% Sheerweave 2705	102	102	Yes
RB6	Brilliance Blackout	102	NA	
RB5	Claudio Blackout	102	NA	
AS005	5% Willow Screen	102	102	Yes
AS007	5% Spectra Screen	102	102	Yes

Top Treatment	Legend	
Medium Cassette		
3" Fascia		
Large Cassette		
Square Cassette		
Fabric Cornice		
4" Fascia		
Open Roll		

Fabric Group: I

Shade size (in)	36	42	48	54	60	66	72	78	84	90	96	102
36												
42												
48												
54												
60												
66												
72												
78												
84												
90												
96												
102												
108												
114												
120												

Control SyStem	***Minimum Width (Single Panel)	***Overall Minimum Width (2 on 1)	Minimum Height	Top Treatment
Cordless Lift	18"	NA	24"	All

PRODUCT SIZE SPECIFICATIONS – CORDLESS LIFT

Fabric Group: J

Fabric Code	Material Name	Max Width Non-Railroaded	Max Width Railroaded	Available with Seam
P7400	Sheerweave 7400	102	NA	
AB030	Alpine Blackout	102	102	Yes
AB004	ZEN Blackout	78 3/4**	NA	
RB4	Carrara Blackout	102	NA	

**To determine the maximum width for continuous Fabric Cornices, subtract 4 inches from the maximum non-railroad width.

Top Treatment	Legend	
Medium Cassette		
3" Fascia		
Large Cassette		
Square Cassette		
Fabric Cornice		
4" Fascia		
Open Roll		

Fabric Group: J

Shade size (in)	36	42	48	54	60	66	72	78	84	90	96	102
36												
42												
48												
54												
60												
66												
72												
78												
84												
90												
96												
102												
108												
114												
120												

Control SyStem	***Minimum Width (Single Panel)	***Overall Minimum Width (2 on 1)	Minimum Height	Top Treatment
Cordless Lift	18"	NA	24"	All

PRODUCT SIZE SPECIFICATIONS – CORDLESS LIFT

Fabric Group: K

Fabric Code	Material Name	Max Width Non-Railroaded	Max Width Railroaded	Available with Seam
RB13	Ranger Blackout	102	NA	
AB026	Delhi Blackout	102	NA	
AB025	Heritage Blackout	102	NA	
P7700R	Sheerweave 7700R	102	NA	
P2703	3% Sheerweave 2703	102	102	
RB1	Santa Cruz Blackout	94**	NA	
AS006	3% Tweed Screen	102	102	
P4500	5% Sheerweave 4500	102	102	
RS25	5% Nordic Screen Plus	102	102	
R80	1% E Screen	102	102	
P2000	5% Sheerweave 2000	102	102	
R06	3% Sheerweave 2410	102	102	

**To determine the maximum width for continuous Fabric Cornices, subtract 4 inches from the maximum non-railroad width.

Top Treatment	Legend	
Medium Cassette		
3" Fascia		
Large Cassette		
Square Cassette		
Fabric Cornice		
4" Fascia		
Open Roll		

Fabric Group: K

Shade size (in)	36	42	48	54	60	66	72	78	84	90	96	102
36												
42												
48												
54												
60												
66												
72												
78												
84												
90												
96												

Control SyStem	***Minimum Width (Single Panel)	***Overall Minimum Width (2 on 1)	Minimum Height	Top Treatment
Cordless Lift	18"	NA	24"	All

PRODUCT SIZE SPECIFICATIONS – CORDLESS LIFT

Fabric Group: L

Fabric Code	Material Name	Max Width Non-Railroaded	Max Width Railroaded	Available with Seam
R34	7% Sheerweave 5000 (Q46, S73)	98**	102	Yes
R26	10% Sheerweave 5000	98**	102	Yes
R10	5% Sheerweave 5000 (Q43)	98**	102	Yes

**To determine the maximum width for continuous Fabric Cornices, subtract 4 inches from the maximum non-railroad width.

Top Treatment	Legend	
Medium Cassette		
3" Fascia		
Large Cassette		
Square Cassette		
Fabric Cornice		
4" Fascia		
Open Roll		

Fabric Group: L

Shade size (in)	36	42	48	54	60	66	72	78	84	90	96	102
36												
42												
48												
54												
60												
66												
72												
78												
84												
90												
96												

Control System	***Minimum Width (Single Panel)	***Overall Minimum Width (2 on 1)	Minimum Height	Top Treatment
Cordless Lift	18"	NA	24"	All

PRODUCT SIZE SPECIFICATIONS – CORDLESS LIFT

Fabric Group: M

Fabric Code	Material Name	Max Width Non-Railroaded	Max Width Railroaded	Available with Seam
AB018	Juniper Blackout	102	102	
AS026	3% Delhi	102	NA	
AS027	3% Lady Amherst	102	NA	
AS029	3% Sovereign	102	NA	
AS028	3% Bamboo	102	NA	
AS024	3% Bellflower	102	NA	
P4903	3% Sheerweave 4903	98**	102	Yes
AS012	5% EnduroScreen	98**	102	Yes
RS24	3% Nordic Screen Plus	102	102	
RS21	1% Sheerweave 2701	102	102	

**To determine the maximum width for continuous Fabric Cornices, subtract 4 inches from the maximum non-railroad width.

Top Treatment	Legend	
Medium Cassette		
3" Fascia		
Large Cassette		
Square Cassette		
Fabric Cornice		
4" Fascia		
Open Roll		

Fabric Group: M

Shade size (in)	36	42	48	54	60	66	72	78	84	90	96	102
36												
42												
48												
54												
60												
66												
72												
78												
84												
90												
96												

Control SyStem	***Minimum Width (Single Panel)	***Overall Minimum Width (2 on 1)	Minimum Height	Top Treatment
Cordless Lift	18"	NA	24"	All

PRODUCT SIZE SPECIFICATIONS – CORDLESS LIFT

Fabric Group: N

Fabric Code	Material Name	Max Width Non-Railroaded	Max Width Railroaded	Available with Seam
R10	5% Sheerweave 5000 (01, 03, 07,09, 10, 14, 15, 19)	98**	102	Yes

**To determine the maximum width for continuous Fabric Cornices, subtract 4 inches from the maximum non-railroad width.

Top Treatment	Legend	
Medium Cassette		
3" Fascia		
Large Cassette		
Square Cassette		
Fabric Cornice		
4" Fascia		
Open Roll		

Fabric Group: N

Shade size (in)	36	42	48	54	60	66	72	78	84	90	96	102
36												
42												
48												
54												
60												
66												
72												
78												
84												
90												
96												

Control SyStem	***Minimium Width (Single Panel)	***Overall Minimum Width (2 on 1)	Minimum Height	Top Treatment
Cordless Lift	18"	NA	24"	All

PRODUCT SIZE SPECIFICATIONS – CORDLESS LIFT

Fabric Group: O

Fabric Code	Material Name	Max Width Non-Railroaded	Max Width Railroaded	Available with Seam
RS23	1% Nordic Screen Plus	102	102	
P4901	1% Sheerweave 4901	98**	102	Yes
R34	7% Sheerweave 5000 (08)	98**	102	Yes
R01	1% Sheerweave 2500	102	102	
AS011	3% EnduroScreen	98**	102	Yes

**To determine the maximum width for continuous Fabric Cornices, subtract 4 inches from the maximum non-railroad width.

Top Treatment	Legend	
Medium Cassette		
3" Fascia		
Large Cassette		
Square Cassette		
Fabric Cornice		
4" Fascia		
Open Roll		

Fabric Group: O

Shade size (in)	36	42	48	54	60	66	72	78	84	90	96	102
36												
42												
48												
54												
60												
66												
72												
78												
84												
90												
96												

Control SyStem	***Minimum Width (Single Panel)	***Overall Minimum Width (2 on 1)	Minimum Height	Top Treatment
Cordless Lift	18"	NA	24"	All

PRODUCT SIZE SPECIFICATIONS – CORDLESS LIFT

Fabric Group: P

Fabric Code	Material Name	Max Width Non-Railroaded	Max Width Railroaded	Available with Seam
R07	3% Sheerweave 5000 (R89)	98**	102	Yes

**To determine the maximum width for continuous Fabric Cornices, subtract 4 inches from the maximum non-railroad width.

Top Treatment	Legend	
Medium Cassette		
3" Fascia		
Large Cassette		
Square Cassette		
Fabric Cornice		
4" Fascia		
Open Roll		

Fabric Group: P

Shade size (in)	36	42	48	54	60	66	72	78	84	90	96	102
36												
42												
48												
54												
60												
66												
72												
78												
84												
90												
96												

Control SyStem	***Minimium Width (Single Panel)	***Overall Minimium Width (2 on 1)	Minimum Height	Top Treatment
Cordless Lift	18"	NA	24"	All

PRODUCT SIZE SPECIFICATIONS – CORDLESS LIFT

Fabric Group: Q

Fabric Code	Material Name	Max Width Non-Railroaded	Max Width Railroaded	Available with Seam
P4100	10% Sheerweave 4100	96**	96	
AS010	1% EnduroScreen	96**	96	
P4600	3% Sheerweave 4600	96**	96	

**To determine the maximum width for continuous Fabric Cornices, subtract 4 inches from the maximum non-railroad width.

Top Treatment	Legend	
Medium Cassette		
3" Fascia		
Large Cassette		
Square Cassette		
Fabric Cornice		
4" Fascia		
Open Roll		

Fabric Group: Q

Shade size (in)	36	42	48	54	60	66	72	78	84	90	96
36											
42											
48											
54											
60											
66											
72											
78											
84											

Control SyStem	***Minimum Width (Single Panel)	***Overall Minimum Width (2 on 1)	Minimum Height	Top Treatment
Cordless Lift	18"	NA	24"	All

PRODUCT SIZE SPECIFICATIONS – CORDLESS LIFT

Fabric Group: R

Fabric Code	Material Name	Max Width Non-Railroaded	Max Width Railroaded	Available with Seam
R07	3% Sheerweave 5000 (02, 04, 05, 07, 10)	96**	96	
P5001	1% Sheerweave 5000	96**	96	

**To determine the maximum width for continuous Fabric Cornices, subtract 4 inches from the maximum non-railroad width.

Top Treatment	Legend	
Medium Cassette		
3" Fascia		
Large Cassette		
Square Cassette		
Fabric Cornice		
4" Fascia		
Open Roll		

Fabric Group: R

Shade size (in)	36	42	48	54	60	66	72	78	84	90	96
36											
42											
48											
54											
60											
66											
72											
78											
84											

Control SyStem	***Minimium Width (Single Panel)	***Overall Minimium Width (2 on 1)	Minimum Height	Top Treatment
Cordless Lift	18"	NA	24"	All

PRODUCT SIZE SPECIFICATIONS – CORDLESS LIFT

Fabric Group: S

Fabric Code	Material Name	Max Width Non-Railroaded	Max Width Railroaded	Available with Seam
R09	5% Sheerweave 4000	96	96	

Top Treatment	Legend	
Medium Cassette		
3" Fascia		
Large Cassette		
Square Cassette		
Fabric Cornice		
4" Fascia		
Open Roll		

Fabric Group: S

Shade size (in)	36	42	48	54	60	66	72	78	84	90	96
36											
42											
48											
54											
60											
66											
72											
78											
84											

Control SyStem	***Minimium Width (Single Panel)	***Overall Minimium Width (2 on 1)	Minimum Height	Top Treatment
Cordless Lift	18"	NA	24"	All

PRODUCT SIZE SPECIFICATIONS – CORDLESS LIFT

Fabric Group: T

Fabric Code	Material Name	Max Width Non-Railroaded	Max Width Railroaded	Available with Seam
RS15	4% S Screen	96	NA	
RS2	3% Sheerweave 4400	96	96	
RS7	1% S Screen	96	NA	
P4001	1% Sheerweave 4001	96	96	

Top Treatment	Legend	
Medium Cassette		
3" Fascia		
Large Cassette		
Square Cassette		
Fabric Cornice		
4" Fascia		
Open Roll		

Fabric Group: T

Shade size (in)	36	42	48	54	60	66	72	78	84	90	96
36											
42											
48											
54											
60											
66											
72											
78											
84											

Control System	***Minimum Width (Single Panel)	***Overall Minimum Width (2 on 1)	Minimum Height	Top Treatment
Cordless Lift	18"	NA	24"	All

PRODUCT SIZE SPECIFICATIONS – TOUCHLIFT

Fabric Drops

Railroaded Fabrics (turned width for length) will have a visible seam when fabricated longer than their maximum roll width less 16".

Railroaded Fabrics may have curl edges. This is not considered a defect in the product.

Roll Width is NOT an indicator of maximum shade width. Refer to Product Size Specification Charts for maximum widths.

Minimum shade width – 18 Minimum shade height – 24				No Top Treatment				Fabric Cornice			
Collection Name	Roll Width	RailRoad Option	Splice/Seam	Non-Railroaded		Railroaded		Non-Railroaded		Railroaded	
				Max Width	Max Height	Max Width	Max Height	Max Width	Max Height	Max Width	Max Height
1% E Screen	122	Yes	Yes	84	84	84	84	84	84	84	84
1% EnduroScreen	98	Yes	Yes	84	84	84	84	84	84	84	84
1% Environs Screen	118	Yes	Yes	84	84	84	84	84	84	84	84
1% Nordic Screen Plus	118	Yes	Yes	84	84	84	84	84	84	84	84
1% S Screen	122	No	No	84	84	N/A	N/A	84	84	N/A	N/A
1% Sheerweave 2500	126	Yes	Yes	84	84	84	84	84	84	84	84
1% Sheerweave 2701	126	Yes	Yes	84	84	84	84	84	84	84	84
1% Sheerweave 4001	126	Yes	Yes	84	84	84	84	84	84	84	84
1% Sheerweave 4901	98	Yes	Yes	84	84	84	84	84	84	84	84
1% Sheerweave 5000 (P5001_R85, R86, R87, R88)	98	Yes	Yes	84	84	84	84	84	84	84	84
1% Sheerweave 5000 (P5001_V17 & V18)	98	Yes	Yes	84	84	84	84	84	84	84	84
3% Bamboo	113	No	No	84	84	NA	NA	84	84	NA	NA
3% Bellflower	113	No	No	84	84	NA	NA	84	84	NA	NA
3% Delhi	113	No	No	84	84	NA	NA	84	84	NA	NA
3% E Screen	122	Yes	Yes	84	84	84	84	84	84	84	84
3% Ecoscape Screen	118	No	No	84	84	NA	NA	84	84	NA	NA
3% EnduroScreen	98	Yes	Yes	84	84	84	84	84	84	84	84
3% Environs Screen	118	Yes	Yes	84	84	84	84	84	84	84	84
3% Lady Amherst	113	No	No	84	84	NA	NA	84	84	NA	NA
3% Nordic Screen Plus	118	Yes	Yes	84	84	84	84	84	84	84	84
3% Sheerweave 2410	126	Yes	Yes	84	84	84	84	84	84	84	84
3% Sheerweave 2703	126	Yes	Yes	84	84	84	84	84	84	84	84
3% Sheerweave 4400	126	Yes	Yes	84	84	84	84	84	84	84	84
3% Sheerweave 4600	98	Yes	Yes	84	84	84	84	84	84	84	84
3% Sheerweave 4903	98	Yes	Yes	84	84	84	84	84	84	84	84
3% Sheerweave 5000 (02, 04, 05, 07, 10,)	98	Yes	Yes	84	84	84	84	84	84	84	84
3% Sheerweave 5000 (R89)	98	Yes	Yes	84	84	84	84	84	84	84	84
3% Sovereign	113	No	No	84	84	NA	NA	84	84	NA	NA
3% Tweed Screen	118	Yes	Yes	84	84	84	84	84	84	84	84
4% S Screen	122	No	No	84	84	N/A	N/A	84	84	N/A	N/A
5% E Screen	122	Yes	Yes	84	84	84	84	84	84	84	84
5% Ecoscape Screen	118	No	No	84	84	NA	NA	84	84	NA	NA
5% EnduroScreen	98	Yes	Yes	84	84	84	84	84	84	84	84
5% Environs Screen	118	Yes	Yes	84	84	84	84	84	84	84	84
5% M Screen Deco	98	Yes	Yes	84	84	84	84	84	84	84	84
5% Nordic Screen Plus	118	Yes	Yes	84	84	84	84	84	84	84	84
5% Sheerweave 2000	126	Yes	Yes	84	84	84	84	84	84	84	84
5% Sheerweave 2390	126	Yes	Yes	84	84	84	84	84	84	84	84
5% Sheerweave 2705	98	Yes	Yes	84	84	84	84	84	84	84	84
5% Sheerweave 4000	126	Yes	Yes	84	84	84	84	84	84	84	84
5% Sheerweave 4500	126	Yes	Yes	84	84	84	84	84	84	84	84
5% Sheerweave 5000 (01, 03, 07,09, 10, 14, 15, 19)	98	Yes	Yes	84	84	84	84	84	84	84	84
5% Sheerweave 5000 (Q43)	98	Yes	Yes	84	84	84	84	84	84	84	84
5% Spectra Screen	118	Yes	Yes	84	84	84	84	84	84	84	84
5% Willow Screen	118	Yes	Yes	84	84	84	84	84	84	84	84
7% Sheerweave 5000 (08)	98	Yes	Yes	84	84	84	84	84	84	84	84
7% Sheerweave 5000 (Q46)	98	Yes	Yes	84	84	84	84	84	84	84	84
10% E Screen	122	Yes	Yes	84	84	84	84	84	84	84	84
10% Sheerweave 2360	126	Yes	Yes	84	84	84	84	84	84	84	84
10% Sheerweave 4100	98	Yes	Yes	84	84	84	84	84	84	84	84
10% Sheerweave 5000 (03)	98	Yes	Yes	84	84	84	84	84	84	84	84
10% Sheerweave 5000 (U28, U24, U29)	98	Yes	Yes	84	84	84	84	84	84	84	84

PRODUCT SIZE SPECIFICATIONS – TOUCHLIFT

Fabric Drops

Railroaded Fabrics (turned width for length) will have a visible seam when fabricated longer than their maximum roll width less 16".

Railroaded Fabrics may have curl edges. This is not considered a defect in the product.

Roll Width is NOT an indicator of maximum shade width. Refer to Product Size Specification Charts for maximum widths.

Minimum shade width – 18 Minimum shade height – 24				No Top Treatment				Fabric Cornice			
Collection Name	Roll Width	RailRoad Option	Splice/Seam	Non-Railroaded		Railroaded		Non-Railroaded		Railroaded	
				Max Width	Max Height	Max Width	Max Height	Max Width	Max Height	Max Width	Max Height
Adelaide	118	No	No	84	84	NA	NA	84	84	NA	NA
Adelaide Blackout	114	No	No	84	84	NA	NA	84	84	NA	NA
Aegean	78 3/4	No	No	78	84	NA	NA	74	84	NA	NA
Alpine	118	Yes	Yes	84	84	84	84	84	84	84	84
Alpine Blackout	118	Yes	Yes	84	84	84	84	84	84	84	84
Aqua-Tex	118	No	No	84	84	NA	NA	84	84	NA	NA
Aqua-Tex Blackout	114	No	No	84	84	NA	NA	84	84	NA	NA
Arches	118	No	No	84	84	NA	NA	84	84	NA	NA
Arches Blackout	118	No	No	84	84	NA	NA	84	84	NA	NA
Aries Blackout	118	No	No	84	84	NA	NA	84	84	NA	NA
Baltic	110	No	No	84	84	NA	NA	84	84	NA	NA
Baltic Blackout	110	No	No	84	84	NA	NA	84	84	NA	NA
Bamboo	113	No	No	84	84	NA	NA	84	84	NA	NA
Bamboo Blackout	113	No	No	84	84	NA	NA	84	84	NA	NA
Bellflower	113	No	No	84	84	NA	NA	84	84	NA	NA
Bellflower Blackout	113	No	No	84	84	NA	NA	84	84	NA	NA
Blackout - Solid	72	Yes	Yes	72	84	84	84	62	84	84	84
Bonn	98	Yes	Yes	84	84	84	84	84	84	84	84
Brilliance	118	No	No	84	84	N/A	N/A	84	84	N/A	N/A
Brilliance Blackout	118	No	No	84	84	N/A	N/A	84	84	N/A	N/A
Burton	110	No	No	84	84	NA	NA	84	84	NA	NA
Carrara	110	No	No	84	84	N/A	N/A	84	84	N/A	N/A
Carrara Blackout	110	No	No	84	84	N/A	N/A	84	84	N/A	N/A
Chesapeake Blackout	94	No	No	84	84	N/A	N/A	84	84	N/A	N/A
Claudio	110	No	No	84	84	N/A	N/A	84	84	N/A	N/A
Claudio Blackout	110	No	No	84	84	N/A	N/A	84	84	N/A	N/A
Cusco Blackout	110	No	No	84	84	NA	NA	84	84	NA	NA
Delhi	105	No	No	84	84	NA	NA	84	84	NA	NA
Delhi Blackout	105	No	No	84	84	NA	NA	84	84	NA	NA
Drizzle	94	Yes	Yes	78	84	84	84	68	84	84	84
Fuji	78 3/4	Yes	Yes	78	84	78	84	74	84	84	84
Heritage	110	No	No	84	84	NA	NA	84	84	NA	NA
Heritage Blackout	105	No	No	84	84	NA	NA	84	84	NA	NA
Horizon Blackout	105	No	No	84	84	NA	NA	84	84	NA	NA
Juniper	110	Yes	Yes	84	84	84	84	84	84	84	84
Juniper Blackout	110	Yes	Yes	84	84	84	84	84	84	84	84
Lady Amherst	113	No	No	84	84	NA	NA	84	84	NA	NA
Lady Amherst Blackout	113	No	No	84	84	NA	NA	84	84	NA	NA
Lavish	110	No	No	84	84	NA	NA	84	84	NA	NA
Linview	122	Yes	Yes	84	84	84	84	84	84	84	84
Linview Blackout	120	Yes	Yes	84	84	84	84	84	84	84	84
Montero	94	No	No	84	84	N/A	N/A	84	84	N/A	N/A
Opulence Room Darkening	78 3/4	No	No	78	84	NA	NA	74	84	NA	NA
Pacific	122	No	No	84	84	NA	NA	84	84	NA	NA
Pacific Blackout	121	No	No	84	84	NA	NA	84	84	NA	NA

PRODUCT SIZE SPECIFICATIONS – TOUCHLIFT

Fabric Drops

Railroaded Fabrics (turned width for length) will have a visible seam when fabricated longer than their maximum roll width less 16".

Railroaded Fabrics may have curl edges. This is not considered a defect in the product.

Roll Width is NOT an indicator of maximum shade width. Refer to Product Size Specification Charts for maximum widths.

Minimum shade width – 18 Minimum shade height – 24				No Top Treatment				Fabric Cornice			
Collection Name	Roll Width	RailRoad Option	Splice/Seam	Non-Railroaded		Railroaded		Non-Railroaded		Railroaded	
				Max Width	Max Height	Max Width	Max Height	Max Width	Max Height	Max Width	Max Height
Queenland	108	No	No	84	84	NA	NA	84	84	NA	NA
Queenland Blackout	108	No	No	84	84	NA	NA	84	84	NA	NA
Ranger	110	No	No	84	84	N/A	N/A	84	84	N/A	N/A
Ranger Blackout	110	No	No	84	84	N/A	N/A	84	84	N/A	N/A
Rhine	110	No	No	84	84	NA	NA	84	84	NA	NA
Santa Cruz	94	No	No	84	84	N/A	N/A	84	84	N/A	N/A
Santa Cruz Blackout	94	No	No	84	84	N/A	N/A	84	84	N/A	N/A
Scala Blackout	110	Yes	Yes	84	84	84	84	84	84	84	84
Sequoia	110	Yes	Yes	84	84	84	84	84	84	84	84
Sheerweave 7000	118	Yes	Yes	84	84	84	84	84	84	84	84
Sheerweave 7200R	118	No	No	84	84	N/A	N/A	84	84	N/A	N/A
Sheerweave 7250R	118	No	No	84	84	N/A	N/A	84	84	N/A	N/A
Sheerweave 7400	118	No	No	84	84	N/A	N/A	84	84	N/A	N/A
Sheerweave 7450	118	No	No	84	84	N/A	N/A	84	84	N/A	N/A
Sheerweave 7500	118	Yes	Yes	84	84	84	84	84	84	84	84
Sheerweave 7500R	118	Yes	Yes	84	84	84	84	84	84	84	84
Sheerweave 7700R	118	No	No	84	84	N/A	N/A	84	84	N/A	N/A
Sheerweave 7750R	118	No	No	84	84	N/A	N/A	84	84	N/A	N/A
Sorrento	108	No	No	84	84	N/A	N/A	84	84	N/A	N/A
Urban	118	Yes	Yes	84	84	84	84	84	84	84	84
URBAN Room Darkening	118	Yes	Yes	84	84	84	84	84	84	84	84
Vail	110	No	No	84	84	N/A	N/A	84	84	N/A	N/A
Vail Blackout	110	Yes	Yes	84	84	84	84	84	84	84	84
York	118	No	No	84	84	NA	NA	84	84	NA	NA
ZEN Blackout	78 3/4	No	No	78	84	NA	NA	74	84	NA	NA

PRODUCT SIZE SPECIFICATIONS – TOUCHLIFT

Railroaded Fabrics (turned width for length) will have a visible seam when fabricated longer than their maximum roll width less 16".

Railroaded Fabrics may have curl edges. This is not considered a defect in the product.

Roll Width is NOT an indicator of maximum shade width. Refer to Product Size Specification Charts for maximum widths.

Minimum shade width – 18 Minimum shade height – 24				Medium Curved Cassette				Large Curved Cassette / Square Cassette / 3" Fascia / 4" Fascia			
Collection Name	Roll Width	RailRoad Option	Splice/Seam	Non-Railroaded		Railroaded		Non-Railroaded		Railroaded	
				Max Width	Max Height	Max Width	Max Height	Max Width	Max Height	Max Width	Max Height
1% E Screen	122	Yes	Yes	84	84	84	84	84	84	84	84
1% EnduroScreen	98	Yes	Yes	84	84	84	84	84	84	84	84
1% Environs Screen	118	Yes	Yes	84	84	84	84	84	84	84	84
1% Nordic Screen Plus	118	Yes	Yes	84	84	84	84	84	84	84	84
1% S Screen	122	No	No	84	60	N/A	N/A	84	84	N/A	N/A
1% Sheerweave 2500	126	Yes	Yes	84	84	84	84	84	84	84	84
1% Sheerweave 2701	126	Yes	Yes	84	84	84	84	84	84	84	84
1% Sheerweave 4001	126	Yes	Yes	84	84	84	84	84	84	84	84
1% Sheerweave 4901	98	Yes	Yes	84	84	84	84	84	84	84	84
1% Sheerweave 5000 (P5001_R85, R86, R87, R88)	98	Yes	Yes	84	54	84	54	84	84	84	84
1% Sheerweave 5000 (P5001_V17 & V18)	98	Yes	Yes	84	60	84	60	84	84	84	84
3% Bamboo	113	No	No	84	84	NA	NA	84	84	NA	NA
3% Bellflower	113	No	No	84	84	NA	NA	84	84	NA	NA
3% Delhi	113	No	No	84	84	NA	NA	84	84	NA	NA
3% E Screen	122	Yes	Yes	84	84	84	84	84	84	84	84
3% Ecoscape Screen	118	No	No	84	84	NA	NA	84	84	NA	NA
3% EnduroScreen	98	Yes	Yes	84	84	84	84	84	84	84	84
3% Environs Screen	118	Yes	Yes	84	84	84	84	84	84	84	84
3% Lady Amherst	113	No	No	84	84	NA	NA	84	84	NA	NA
3% Nordic Screen Plus	118	Yes	Yes	84	84	84	84	84	84	84	84
3% Sheerweave 2410	126	Yes	Yes	84	84	84	84	84	84	84	84
3% Sheerweave 2703	126	Yes	Yes	84	84	84	84	84	84	84	84
3% Sheerweave 4400	126	Yes	Yes	84	81	84	84	84	84	84	84
3% Sheerweave 4600	98	Yes	Yes	84	84	84	84	84	84	84	84
3% Sheerweave 4903	98	Yes	Yes	84	84	84	84	84	84	84	84
3% Sheerweave 5000 (02, 04, 05, 07, 10,)	98	Yes	Yes	84	44	84	44	*84	*60	84	*60
3% Sheerweave 5000 (R89)	98	Yes	Yes	84	48	84	48	*84	*68	84	*68
3% Sovereign	113	No	No	84	84	NA	NA	84	84	NA	NA
3% Tweed Screen	118	Yes	Yes	84	84	84	84	84	84	84	84
4% S Screen	122	No	No	84	63	N/A	N/A	84	84	N/A	N/A
5% E Screen	122	Yes	Yes	84	84	84	84	84	84	84	84
5% Ecoscape Screen	118	No	No	84	84	NA	NA	84	84	NA	NA
5% EnduroScreen	98	Yes	Yes	84	84	84	84	84	84	84	84
5% Environs Screen	118	Yes	Yes	84	84	84	84	84	84	84	84
5% M Screen Deco	98	Yes	Yes	84	84	84	84	84	84	84	84
5% Nordic Screen Plus	118	Yes	Yes	84	84	84	84	84	84	84	84
5% Sheerweave 2000	126	Yes	Yes	84	84	84	84	84	84	84	84
5% Sheerweave 2390	126	Yes	Yes	84	84	84	84	84	84	84	84
5% Sheerweave 2705	98	Yes	Yes	84	84	84	84	84	84	84	84
5% Sheerweave 4000	126	Yes	Yes	84	84	84	84	84	84	84	84
5% Sheerweave 4500	126	Yes	Yes	84	84	84	84	84	84	84	84
5% Sheerweave 5000 (01, 03, 07,09, 10, 11, 14, 15, 19)	98	Yes	Yes	84	68	84	68	84	84	84	84
5% Sheerweave 5000 (Q43)	98	Yes	Yes	84	70	84	70	84	84	84	84
5% Spectra Screen	118	Yes	Yes	84	84	84	84	84	84	84	84
5% Willow Screen	118	Yes	Yes	84	84	84	84	84	84	84	84
7% Sheerweave 5000 (08)	98	Yes	Yes	84	80	84	80	84	84	84	84
7% Sheerweave 5000 (Q46)	98	Yes	Yes	84	56	84	56	84	84	84	84
10% E Screen	122	Yes	Yes	84	84	84	84	84	84	84	84
10% Sheerweave 2360	126	Yes	Yes	84	84	84	84	84	84	84	84
10% Sheerweave 4100	98	Yes	Yes	84	78	84	78	84	84	84	84
10% Sheerweave 5000 (03)	98	Yes	Yes	84	64	84	64	84	84	84	84
10% Sheerweave 5000 (U28, U24, U29)	98	Yes	Yes	84	64	84	64	84	84	84	84

PRODUCT SIZE SPECIFICATIONS – TOUCHLIFT

Fabric Drops

Railroaded Fabrics (turned width for length) will have a visible seam when fabricated longer than their maximum roll width less 16".

Railroaded Fabrics may have curl edges. This is not considered a defect in the product.

Roll Width is NOT an indicator of maximum shade width. Refer to Product Size Specification Charts for maximum widths.

Minimum shade width – 18 Minimum shade height – 24				Medium Curved Cassette				Large Curved Cassette / Square Cassette / 3" Fascia / 4" Fascia			
Collection Name	Roll Width	RailRoad Option	Splice/ Seam	Non-Railroaded		Railroaded		Non-Railroaded		Railroaded	
				Max Width	Max Height	Max Width	Max Height	Max Width	Max Height	Max Width	Max Height
Adelaide	118	No	No	84	84	NA	NA	84	84	NA	NA
Adelaide Blackout	114	No	No	84	84	NA	NA	84	84	NA	NA
Aegean	78 3/4	No	No	74	84	NA	NA	78	84	NA	NA
Alpine	118	Yes	Yes	84	84	84	84	84	84	84	84
Alpine Blackout	118	Yes	Yes	84	84	84	84	84	84	84	84
Aqua-Tex	118	No	No	84	84	NA	NA	84	84	NA	NA
Aqua-Tex Blackout	114	No	No	84	84	NA	NA	84	84	NA	NA
Arches	118	No	No	84	84	NA	NA	84	84	NA	NA
Arches Blackout	118	No	No	84	84	NA	NA	84	84	NA	NA
Aries Blackout	118	No	No	84	84	NA	NA	84	84	NA	NA
Baltic	110	No	No	84	84	NA	NA	84	84	NA	NA
Baltic Blackout	110	No	No	84	84	NA	NA	84	84	NA	NA
Bamboo	113	No	No	84	84	NA	NA	84	84	NA	NA
Bamboo Blackout	113	No	No	84	84	NA	NA	84	84	NA	NA
Bellflower	113	No	No	84	84	NA	NA	84	84	NA	NA
Bellflower Blackout	113	No	No	84	84	NA	NA	84	84	NA	NA
Blackout - Solid	72	Yes	Yes	72	84	84	84	72	84	84	84
Bonn	98	Yes	Yes	84	84	84	84	84	84	84	84
Brilliance	118	No	No	84	84	N/A	N/A	84	84	N/A	N/A
Brilliance Blackout	118	No	No	84	84	N/A	N/A	84	84	N/A	N/A
Burton	110	No	No	84	84	NA	NA	84	84	NA	NA
Carrara	110	No	No	84	84	N/A	N/A	84	84	N/A	N/A
Carrara Blackout	110	No	No	84	84	N/A	N/A	84	84	N/A	N/A
Chesapeake Blackout	94	No	No	84	84	N/A	N/A	84	84	N/A	N/A
Claudio	110	No	No	84	84	N/A	N/A	84	84	N/A	N/A
Claudio Blackout	110	No	No	84	84	N/A	N/A	84	84	N/A	N/A
Cusco Blackout	110	No	No	84	84	NA	NA	84	84	NA	NA
Delhi	105	No	No	84	84	NA	NA	84	84	NA	NA
Delhi Blackout	105	No	No	84	84	NA	NA	84	84	NA	NA
Drizzle	78	Yes	Yes	78	84	84	84	78	84	84	84
Fuji	78 3/4	Yes	Yes	74	84	84	84	78	84	78	84
Heritage	105	No	No	84	84	NA	NA	84	84	NA	NA
Heritage Blackout	105	No	No	84	84	NA	NA	84	84	NA	NA
Horizon Blackout	110	No	No	84	84	NA	NA	84	84	NA	NA
Juniper	110	Yes	Yes	84	84	84	84	84	84	84	84
Juniper Blackout	110	Yes	Yes	84	82	84	82	84	84	84	84
Lady Amherst	113	No	No	84	84	NA	NA	84	84	NA	NA
Lady Amherst Blackout	113	No	No	84	84	NA	NA	84	84	NA	NA
Lavish	110	No	No	84	84	NA	NA	84	84	NA	NA
Linview	122	Yes	Yes	84	84	84	84	84	84	84	84
Linview Blackout	120	Yes	Yes	84	84	84	84	84	84	84	84
Montero	94	No	No	84	84	N/A	N/A	84	84	N/A	N/A
Opulence Room Darkening	78 3/4	No	No	74	82	NA	NA	78	84	NA	NA
Pacific	122	No	No	84	84	NA	NA	84	84	NA	NA
Pacific Blackout	121	No	No	84	84	NA	NA	84	84	NA	NA

PRODUCT SIZE SPECIFICATIONS – TOUCHLIFT

Fabric Drops

Railroaded Fabrics (turned width for length) will have a visible seam when fabricated longer than their maximum roll width less 16".

Railroaded Fabrics may have curl edges. This is not considered a defect in the product.

Roll Width is NOT an indicator of maximum shade width. Refer to Product Size Specification Charts for maximum widths.

Minimum shade width – 18 Minimum shade height – 24				Medium Curved Cassette				Large Curved Cassette / Square Cassette / 3" Fascia / 4" Fascia			
Collection Name	Roll Width	RailRoad Option	Splice/Seam	Non-Railroaded		Railroaded		Non-Railroaded		Railroaded	
				Max Width	Max Height	Max Width	Max Height	Max Width	Max Height	Max Width	Max Height
Queenland	108	No	No	84	84	NA	NA	84	84	NA	NA
Queenland Blackout	108	No	No	84	84	NA	NA	84	84	NA	NA
Ranger	110	No	No	84	84	N/A	N/A	84	84	N/A	N/A
Ranger Blackout	110	No	No	84	84	N/A	N/A	84	84	N/A	N/A
Rhine	110	No	No	84	84	NA	NA	84	84	NA	NA
Santa Cruz	94	No	No	84	84	N/A	N/A	84	84	N/A	N/A
Santa Cruz Blackout	94	No	No	84	84	N/A	N/A	84	84	N/A	N/A
Scala Blackout	110	Yes	Yes	84	84	84	84	84	84	84	84
Sequoia	110	Yes	Yes	84	84	84	84	84	84	84	84
Sheerweave 7000	118	Yes	Yes	84	84	84	84	84	84	84	84
Sheerweave 7200R	118	No	No	84	84	N/A	N/A	84	84	N/A	N/A
Sheerweave 7250R	118	No	No	84	84	N/A	N/A	84	84	N/A	N/A
Sheerweave 7400	118	No	No	84	84	N/A	N/A	84	84	N/A	N/A
Sheerweave 7450	118	No	No	84	84	N/A	N/A	84	84	N/A	N/A
Sheerweave 7500	118	Yes	Yes	84	84	84	84	84	84	84	84
Sheerweave 7500R	118	Yes	Yes	84	84	84	84	84	84	84	84
Sheerweave 7700R	118	No	No	84	84	N/A	N/A	84	84	N/A	N/A
Sheerweave 7750R	118	No	No	84	84	N/A	N/A	84	84	N/A	N/A
Sorrento	108	No	No	84	84	N/A	N/A	84	84	N/A	N/A
Urban	118	Yes	Yes	84	84	84	84	84	84	84	84
URBAN Room Darkening	118	Yes	Yes	84	84	84	84	84	84	84	84
Vail	110	No	No	84	84	N/A	N/A	84	84	N/A	N/A
Vail Blackout	110	Yes	Yes	84	84	84	84	84	84	84	84
York	118	No	No	84	84	NA	NA	84	84	NA	NA
ZEN Blackout	78 3/4	No	No	74	84	NA	NA	78	84	NA	NA

PRODUCT SIZE SPECIFICATIONS – DUAL MOUNT

Fabric Drops

Railroaded Fabrics (turned width for length) will have a visible seam when fabricated longer than their maximum roll width less 16".
 Railroaded Fabrics may have curl edges. This is not considered a defect in the product.

Roll Width is NOT an indicator of maximum shade width. Refer to Product Size Specification Charts for maximum widths.

Dual Mount:				Continuous Loop Control Bliss™ DC 1.1, Bliss™ 1.0 Li-Ion, Bliss™ 2.0 Li-Ion, Bliss™ DC 2.0, Sonesse® 28 RTS WireFree™ DC, Sonesse® 28 Zigbee WireFree™ DC, Sonesse® 28 WireFree™RTS Li-Ion, Sonesse® 28 WireFree™Zigbee Li-Ion, Sonesse® ULTRA 30 WireFree™ RTS Li-Ion, Sonesse® 30 RTS 24v DC				No Top Treatment and Fabric cornice Cordless Lift				No Top Treatment and Fabric cornice Touchlift 2.0			
<ul style="list-style-type: none"> • Inside mount only • Available under No Top Treatment & Fabric Cornice • Roll Configuration: Reverse (top) / Standard (bottom) • 1.5" tube only 															
Collection Name	Roll Width	Rail/Road Option	Splice/Seam	Non-Railroaded		Railroaded		Non-Railroaded		Railroaded		Non-Railroaded		Railroaded	
				Max Width	Max Height	Max Width	Max Height	Max Width	Max Height	Max Width	Max Height	Max Width	Max Height	Max Width	Max Height
1% E Screen	122	Yes	Yes	84	108	84	108	84	96	84	96	84	84	84	84
1% EnduroScreen	98	Yes	Yes	84	84	84	84	84	84	84	84	84	84	84	84
1% Environs Screen	118	Yes	Yes	84	126	84	126	84	120	84	120	84	84	84	84
1% Nordic Screen Plus	118	Yes	Yes	84	96	84	96	84	84	84	84	84	84	84	84
1% S Screen	122	No	No	84	78	NA	NA	84	70	NA	NA	84	70	NA	NA
1% Sheerweave 2500	126	Yes	Yes	84	96	84	96	84	84	84	84	84	84	84	84
1% Sheerweave 2701	126	Yes	Yes	84	96	84	96	84	84	84	84	84	84	84	84
1% Sheerweave 4001	126	Yes	Yes	84	78	84	78	84	78	84	78	84	78	84	78
1% Sheerweave 4901	98	Yes	Yes	84	96	84	96	84	84	84	84	84	84	84	84
1% Sheerweave 5000	98	Yes	Yes	84	84	84	84	84	80	84	80	84	80	84	80
3% Bamboo	113	No	No	84	96	NA	NA	84	84	NA	NA	84	84	NA	NA
3% Bellflower	113	No	No	84	96	NA	NA	84	84	NA	NA	84	84	NA	NA
3% Delhi	113	No	No	84	96	NA	NA	84	84	NA	NA	84	84	NA	NA
3% E Screen	122	Yes	Yes	84	126	84	126	84	120	84	120	84	84	84	84
3% Ecoscape Screen	118	No	No	84	144	NA	NA	84	120	NA	NA	84	84	NA	NA
3% EnduroScreen	98	Yes	Yes	84	84	84	84	84	84	84	84	84	84	84	84
3% Environs Screen	118	Yes	Yes	84	126	84	126	84	120	84	120	84	84	84	84
3% Lady Amherst	113	No	No	84	96	NA	NA	84	84	NA	NA	84	84	NA	NA
3% Nordic Screen Plus	118	Yes	Yes	84	96	84	96	84	84	84	84	84	84	84	84
3% Sheerweave 2410	126	Yes	Yes	84	108	84	108	84	84	84	84	84	84	84	84
3% Sheerweave 2703	126	Yes	Yes	84	96	84	96	84	84	84	84	84	84	84	84
3% Sheerweave 4400	126	Yes	Yes	84	78	84	78	84	80	84	80	84	80	84	80
3% Sheerweave 4600	98	Yes	Yes	84	84	84	84	84	84	84	84	84	84	84	84
3% Sheerweave 4903	98	Yes	Yes	84	96	84	96	84	84	84	84	84	84	84	84
3% Sheerweave 5000 (02, 04, 05, 07, 10)	98	Yes	Yes	84	70	84	70	84	70	84	70	84	70	84	70
3% Sheerweave 5000 (R89)	98	Yes	Yes	84	80	84	80	84	70	84	70	84	70	84	70
3% Sovereign	113	No	No	84	96	NA	NA	84	84	NA	NA	84	84	NA	NA
3% Tweed Screen	118	Yes	Yes	84	108	84	108	84	96	84	96	84	84	84	84
4% S Screen	122	No	No	84	78	NA	NA	84	84	NA	NA	84	84	NA	NA
5% E Screen	122	Yes	Yes	84	126	84	126	84	120	84	120	84	84	84	84
5% Ecoscape Screen	118	No	No	84	144	NA	NA	84	120	NA	NA	84	84	NA	NA
5% EnduroScreen	98	Yes	Yes	84	96	84	96	84	96	84	96	84	84	84	84
5% Environs Screen	118	Yes	Yes	84	144	84	144	84	120	84	120	84	84	84	84
5% M Screen Deco	98	Yes	Yes	84	126	84	126	84	120	84	120	84	84	84	84
5% Nordic Screen Plus	118	Yes	Yes	84	108	84	108	84	84	84	84	84	84	84	84
5% Sheerweave 2000	126	Yes	Yes	84	96	84	96	84	84	84	84	84	84	84	84
5% Sheerweave 2390	126	Yes	Yes	84	108	84	108	84	96	84	96	84	84	84	84
5% Sheerweave 2705	98	Yes	Yes	84	126	84	126	84	120	84	120	84	84	84	84
5% Sheerweave 4000	126	Yes	Yes	84	78	84	78	84	80	84	80	84	80	84	80
5% Sheerweave 4500	126	Yes	Yes	84	96	84	96	84	84	84	84	84	84	84	84
5% Sheerweave 5000 (01, 03, 07, 09, 10, 14, 15, 19)	98	Yes	Yes	84	90	84	90	84	84	84	84	84	84	84	84
5% Sheerweave 5000 (Q43)	98	Yes	Yes	84	90	84	90	84	84	84	84	84	84	84	84
5% Spectra Screen	118	Yes	Yes	84	108	84	108	84	108	84	108	84	84	84	84
5% Willow Screen	118	Yes	Yes	84	108	84	108	84	108	84	108	84	84	84	84
7% Sheerweave 5000 (08)	98	Yes	Yes	84	96	84	96	84	84	84	84	84	84	84	84
7% Sheerweave 5000 (Q46)	98	Yes	Yes	84	96	84	96	84	84	84	84	84	84	84	84
10% E Screen	122	Yes	Yes	84	126	84	126	84	120	84	120	84	84	84	84
10% Sheerweave 2360	126	Yes	Yes	84	126	84	126	84	120	84	120	84	84	84	84
10% Sheerweave 4100	98	Yes	Yes	84	84	84	84	84	84	84	84	84	84	84	84
10% Sheerweave 5000 (03)	98	Yes	Yes	84	90	84	90	84	84	84	84	84	84	84	84
10% Sheerweave 5000 (U28, U24, U29)	98	Yes	Yes	84	90	84	90	84	84	84	84	84	84	84	84

OPERATING SYSTEM: CONTINUOUS LOOP CONTROL

Continuous Loop Control

This operating systems feature plastic or metal bead chain with tensioner. As the clutch with attached chain is pulled up and down, it rotates the roller tube, enabling the roller shade to be lowered and raised. Bead stops are included to set at upper and lower shade limits.



- Universal brackets – color coordinated to clutch (Black or White)

Defaulted Chain Loop Length

SHADE HEIGHT	LOOP DROP
**12" to 15 7/8"	2/3 of shade height
**16" to 31 7/8"	2/3 of shade height
32" to 37 7/8"	24" loop
38" to 43 7/8"	30" loop
44" to 52 7/8"	36" loop
53" to 61 7/8"	42" loop
62" to 70 7/8"	48" loop
71" to 79 7/8"	54" loop
80" to 88 7/8"	60" loop
89" to 96 7/8"	66" loop
97" to 105 7/8"	72" loop
106" to 123 7/8"	84" loop
124" to 144"	96" loop

**Sizes require metal chain

Plastic bead chains are available in the following colors:

- Black • Bronze • Vanilla • White • Gray

Metal bead chain is available at no additional charge and available in the following colors/finishes:

- Gunmetal • Oil Rubbed Bronze
- Stainless Steel

NOTE: Custom beaded loop lengths may be ordered, but they must be LONGER than the standard loop size for the given shade height (as indicated on the chart). Bead stops are included to set the loop lengths. They cannot be made shorter than the standard size.

NOTE: Metal or stainless steel chain is recommended for all shades over 108" x 90". To avoid heavy pull force with the Continuous Loop Control shade, Powerwand is a great options with a minimal surcharge. SpringAssist is the alternative upgrade for pull force reduction under standard Continuous Loop Control shade. See Spring Assist section for requirements for this option.

Tensioner will color coordinate with the fabric color.
(Changing the tensioner color is not an available option.)



Tensioner color with plastic chain option.

Plastic Chain Color	Tensioner Color
White	White
Vanilla	Vanilla
Gray	Gray
Black	Black
Brown	Bronze

Tensioner color with metal chain option.

Metal Chain Color	Tensioner Color
Stainless Steel	White
Stainless Steel	Vanilla
Stainless Steel	Gray
Stainless Steel	Black
Stainless Steel	Bronze
GunMetal	Black
Oil Rubbed Bronze	Bronze

Cordless Lift

- Effortless positioning of shade with no tugging. Simply raised and lowered the shade to the desired position.
- Maximum Size: 108" x 120" (varies by fabric)
- Minimum Size: 18" x 24"
- Available with
 - o All fabric & screen collections and top treatments
 - o Standard or reversed roll (Reversed roll is not available with fascia and curved cassette)
 - o Single shade or dual mount shade (not available 2-on-1 or 3-on-1)
 - o Omni Curved Wrapped, Omni Curved Unwrapped and Omni Flat Unwrapped Bottom Rail Options
 - o Handles are enclosed to help keep fabric-wrapped bottomrail clean (not available with Omni Flat Bottom Rail). 2 handles will be provided for shades wider than 42"
 - o Extension pole is available to use with handles on curved Omni Bottom rail when shades are hard to reach. Cost for extension pole is listed on the surcharge page



TouchLift

- Lower shade manually by hand
- Shade slowly raises with a slight pull on the bottomrail. See diagram below.

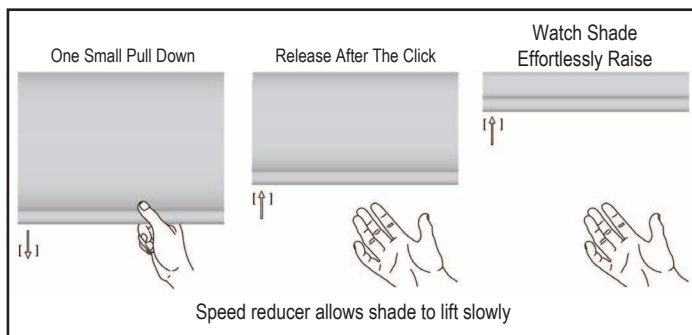

TOP TREATMENT – CASSETTES

Square Cassette

- Available with all operating systems
- Can be fabric-wrapped or non-fabric wrapped (3% Sheerweave 5000 is not available with fabric-wrapped square cassette)
- Available in Matte Colors – White, Vanilla, Silver, Bronze, Black
- Color coordinated end caps and screws
- 4" height x 3-3/4" depth



Curved Cassette

- Sizes: Medium (3-1/8" height x 3-3/4" depth)
Large (3-7/8" height x 3-7/8" depth)
- Available in Matte Colors – White, Vanilla, Silver, Bronze, Black
- Features a fabric insert in the same fabric used for the shade. Insert fabric will run the same direction as the fabric of the shade.
- Available with all operating systems
- No Reverse Roll



TOP TREATMENT – FASCIAS

3" and 4" Fascia

- Available with Continuous Loop Control and Automation (3" Fascia is not available for PowerWand)
- Flat Style Only
- Available in Matte Colors – White, Vanilla, Silver, Bronze, Black
- 2 on 1 is available under Skyline Fascia
- No Reverse Roll

Dimensions

Skyline

3" – 3-3/8" height x 3-1/8" depth

4" – 3-7/8" height x 4-1/8" depth

R-Series

3" – 3" height x 3-1/16" depth

4" – 4" height x 4-1/16" depth



TOP TREATMENT – FABRIC CORNICE

- Can be ordered with shade or as a stand alone cornice
- Minimum Width – 12"
- Maximum Continuous and Stand Alone Valance - 192"
- Standard Cornice Height – 6"
- Optional Cornice Height – 4" & 8"

To avoid any visible seam, fabric cornice ordered width must be 4" less than the fabric roll width. If needed, keystone(s) can be purchased to hide the seams.

Inside Mount:

- Default no returns
- Mounting depth requirement: 1-1/2" plus inside mount shade clearance.

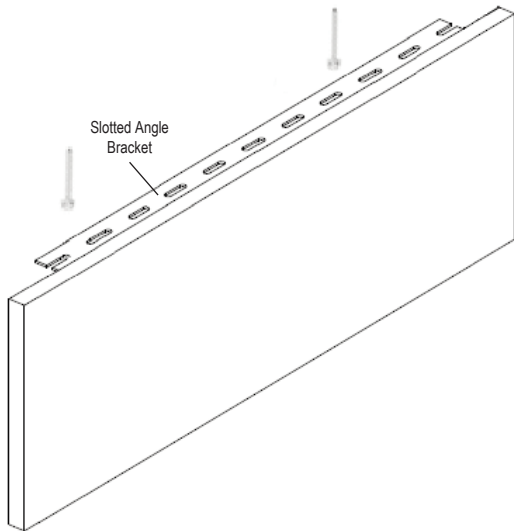

Outside Mount:

- Outside mount is defaulted to 4" return length, with the option to override return lengths from 1-1/2" to 6" in 1/2" increments.
- Dust cover only comes with outside mount cornice: 1-1/2", 4" & 6" return length.

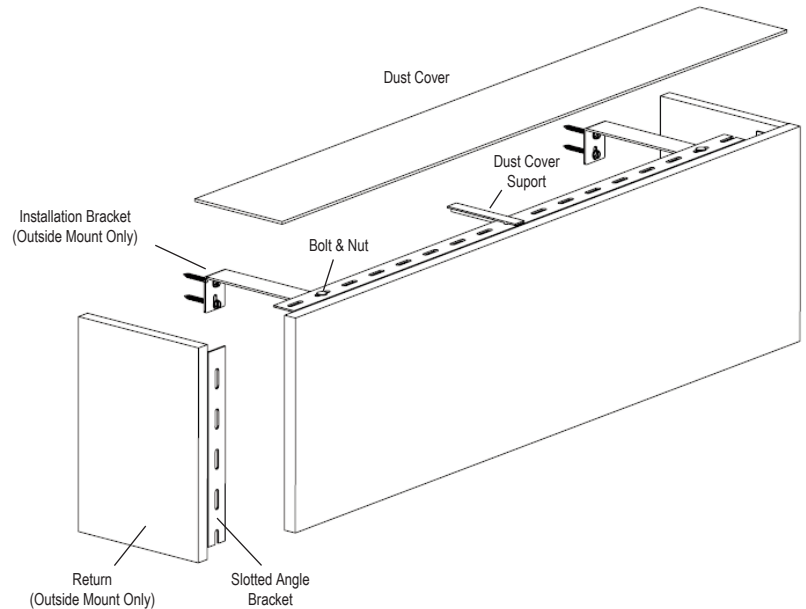

Note: Dust cover only comes with cornice 1-1/2", 4" & 6" return.

Note:

- Custom returns can extend to 6" with outside mount and net mount. 2", 2-1/2", 3", 3-1/2", 4-1/2", 5", and 5-1/2" return sizes include a unique bracket that requires trimming on site.
- The valance return length measures from the front cornice to the end of the return. See image below for reference.
- Cornice thickness is approximate 5/8"

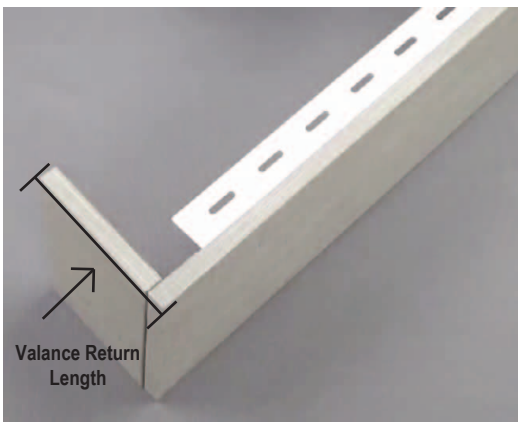

Continuous Valance

Valance NET width must be provided when Fabric Cornice is ordered as continuous valance with the shade.

Note: Finished dimensions varied when ordered with shade or when ordered as a standalone top treatment. See Finished Dimension section for details.

FABRIC CORNICE OPTION

Keystones

- Up to three keystones can be ordered for each cornice (refer to the surcharge page for price)
- Keystone is available in square or trapezoid (wide side up) shape.
- Keystone is also available for ordering with non-spliced cornices under 144".
- All fabric cornices that exceed 144" will be spliced. Brackets with screws will be provided to connect the spliced cornice.

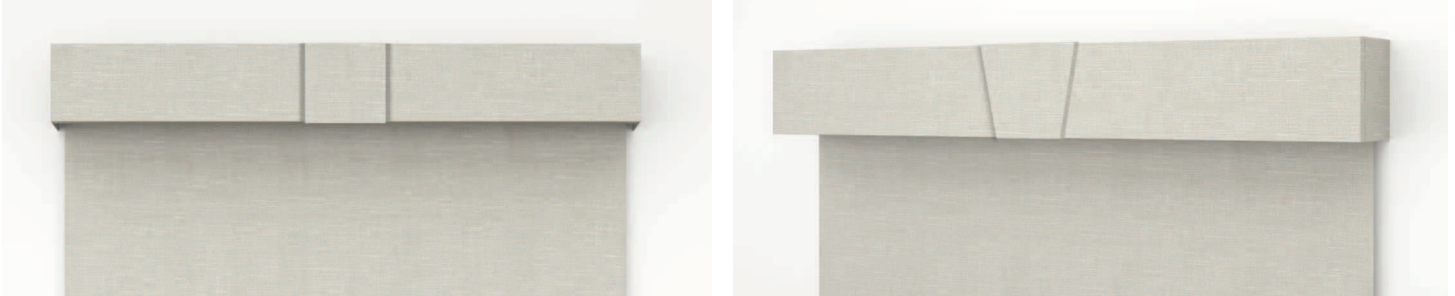

- Splicing Details:
 - Spliced location will be at the center of the keystone(s)
 - Standard Position: Keystones are evenly positioned on the cornice.
 - Custom Position: The location(s) for the keystone(s) can be customized. All spliced sections must be equal to or greater than 12" and cannot exceed 144".

Example:

Cornice Total Width: 120"

1st Keystone (Splice) Location: 20"

2nd Keystone (Splice) Location: 55"

3rd Keystone (Splice) Location: 90"

- All spliced locations should measure from the left edge of the entire cornice to the center of the keystone(s).

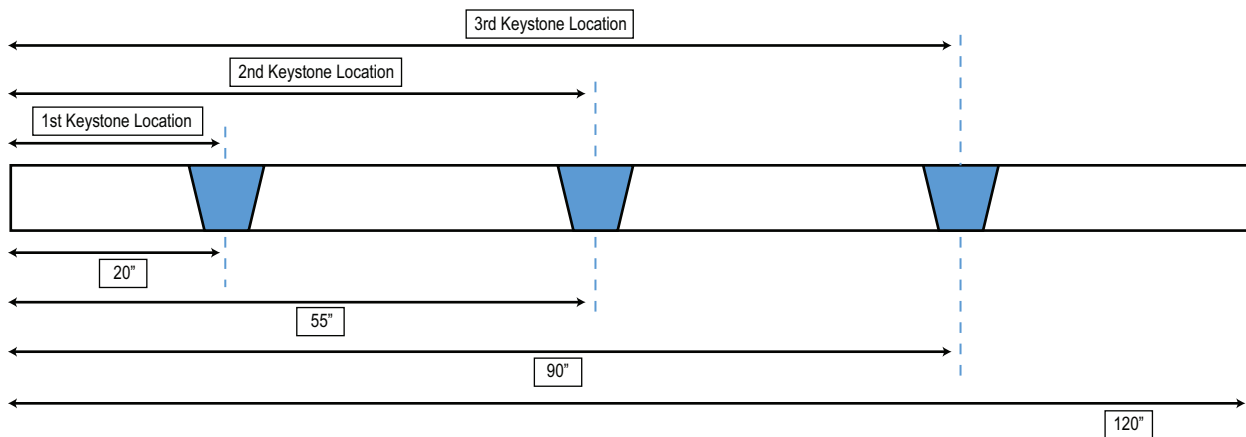

There may be some visual puckering on the cornice when the cornice width exceeds 96". These are normal characteristics and request for remakes and/or credits will not be considered. We strongly recommend splicing the cornice when wider than 96"

DUAL MOUNT SHADE

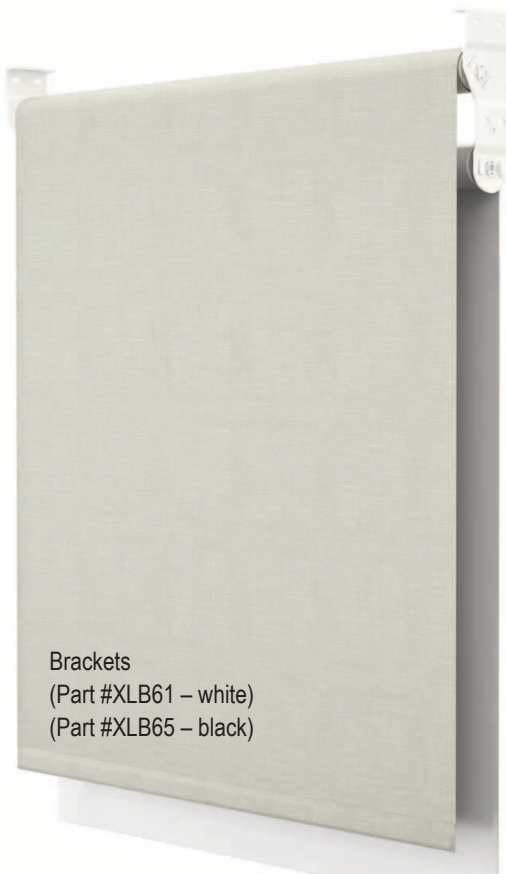

Brackets
(Part #XLB61 – white)
(Part #XLB65 – black)

Vertical Mount

- Inside Mount Only
- Approx. 3" minimum mounting depth for flush mount
- 2" minimum mounting depth for Ceiling Mount
- 5-3/4" Bracket height
- Roll Configuration/Directions: Reverse (top/front facing the room) / Standard (bottom/rear)
 - When combining a Light Filtering material and a Room Darkening/Blackout, we recommend the Room Darkening/Blackout to be the bottom standard roll closest to the window for better light control.
- Available with 6" and 8" Fabric Cornices
- Cassette and Fascia are not available
- To prevent operation interference with the 2 shades, the control position for the back shade will automatically be opposite the front shade.

Dual Mount Bracket Surcharge: Surcharge applies. Refer to price grids.

Dual Mount Operating Systems		Availability
Continuous Loop Control		X
TouchLift		X
Cordless Lift		X
PowerWand 1.0 Li-Ion		-
PowerWand 2.0 Li-Ion		-
Lithium-Ion Motors	Bliss™ 1.1 Li-Ion	X
	Bliss™ 2.0 Li-Ion	X
	Bliss™ 3.0 Li-Ion	-
	Sonessé® 28 WireFree™ RTS Li-Ion	X
	Sonessé® 28 WireFree™ Zigbee Li-Ion	X
	Sonessé® ULTRA 30 WireFree™ Li-Ion	X
DC Motors	Sonessé® 40 WireFree™ RTS Li-Ion	-
	Bliss™ 1.1 DC	X
	Bliss™ 2.0 DC	X
	Sonessé® 28 WireFree™ RTS DC	X
	Sonessé® 28 WireFree™ Zigbee DC	X
AC Motors	Sonessé® 30 RTS 24v DC	X
	Sonessé® 40 ZigBee AC	-
	Sonessé® 50 RTS	-
	Sonessé® ULTRA 50 AC	-
	Bliss™ 10.0 AC	-

SIDE & BOTTOM CHANNELS

Side and Bottom Channels

Aluminum side and bottom channels prevent light leaks around the edges and bottom of the shade.

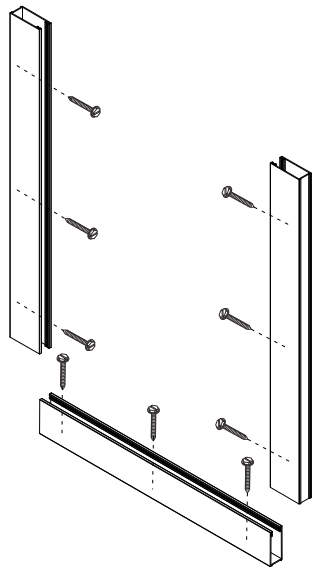

Light Block Brush (Part #445010)
Must be ordered with side and bottom channels if ordered separately



Channels - Surcharge applies. Refer to price grids.

- Inside Mount only
- Available in 5 matte colors: White, Vanilla, Bronze, Anodized, Black
- Additional feature include light blocking wool pile.
- Use with a Heat Sealed hem bar only.
- Not available for Dual Mount
- Cannot be used with fabric cornice and fascia.
- When ordering the side channel, no impact on areas near the top treatment. (may exhibit a halo effect)

Operation System	Medium Curved Cassette	Large Curved Cassette	Square Cassette	
Continuous Cord Loop	X	X	X	
Touchlift	-	-	-	
Cordless Lift	-	-	-	
PowerWand 1.0 Li-Ion	-	-	-	
Powerwand 2.0 Li-Ion	-	-	-	
Bliss™ 1.1 Li-Ion	X	X	X	
Bliss™ 2.0 Li-Ion	X	X	X	
Bliss™ 3.0 Li-Ion	-	X	X	
Bliss™ 1.1 DC	-	-	-	
Bliss™ 2.0 DC	-	-	-	
Bliss™ 10.0 AC	-	-	-	
Sonessé® 28 WireFree™ RTS DC	-	-	-	
Sonessé® 28 WireFree™ Zigbee DC	-	-	-	
Sonessé® 28 WireFree™ RTS Li-Ion Sonessé® 28 WireFree™ Zigbee Li-Ion	X	X	X	
Sonessé® ULTRA 30 WireFree™ RTS Li-Ion	X	X	X	
Sonessé® 40 WireFree™ RTS Li-Ion	-	X	X	
Sonessé® 30 RTS 24v DC	-	-	-	
Sonessé® 50 RTS AC/ Sonessé® ULTRA 50 AC	-	-	-	Spring Ring & Drop In

Deductions (per side channel):

- Bottom channel is always: Order width minus .5" minus mount deduction
- Fabric deduction for R-series: Head-rail width minus 2.75"
- Fabric deduction for Skyline: Head-rail width minus 2.125"
- Fabric deduction for Spring ring & drop in: Head-rail width minus 2.6875"

PRIVACY LIGHT BLOCK

Privacy Light Block

- Available in 5 colors: White, Gray, Vanilla, Bronze and Black
- Inside Mount Only

Surcharge applies; refer to surcharge section.

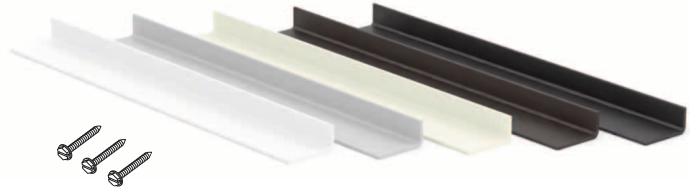

SPRING ASSIST

Spring Assist Skyline Continuous Loop Control

- Available only under 4" Fascia and Open Roll.
- Highly recommended for shades between 80" x 80" and 144" x 144"
- Minimum shade size – 44.4 SQ. FT. with shade width greater than 60"
- Geared spring assist clutch system aids in raising heavy shades by reducing the pull force by up to 40%.
- Spring assist is only available with 2 1/2" tube.



Spring Assist Upgrade Surcharge: Surcharge applies. Refer to surcharge section.

** **PowerWand** is another great alternative option that aids in lifting heavy shades with a minimal surcharge (see **Automation Options** section).

RAILROADING/MATERIAL SPLICING/SEAM PLACEMENT

Railroaded Material

Railroaded material is when the fabric is turned on its side; using the material roll length for the shade width to increase the maximum width when available. Depending on the weaves/construction, many of the fabric collections can be railroaded but with visible seam when the shade is extended. Fabrics that are railroaded may curl along the edge.

When a shade needs to be railroaded, it is highly recommended to railroad all other shades within the same room for a uniform look.

Splicing (Seam Placement)

Custom Splicing (Seam Placement) is available with up to 2 seams per shade at a 15% surcharge. Splice locations are determined from the bottom hem/rail of the shade up. Due to the difficult handling of the material during the seaming process, a 1/4" tolerance per seam in either direction is considered acceptable.

The maximum height for custom seams is equal to the material roll width less 3".

Example – 98" wide material railroaded and seamed has a maximum seam placement of 95".

Seams may be visible when the shade is fully extended. Seams will be placed as close to the tube as possible, location may varied depending upon roll width and shade height.

Although we maintain the highest quality standards, an exact pattern match at the seam on individual shades cannot be guaranteed. Pattern matches from shade to shade, horizontally or vertically, on multiple shade orders cannot be guaranteed.

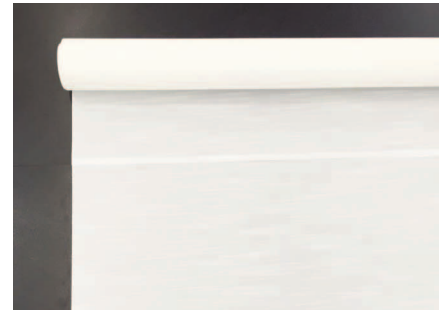

BOTTOMRAIL OPTIONS

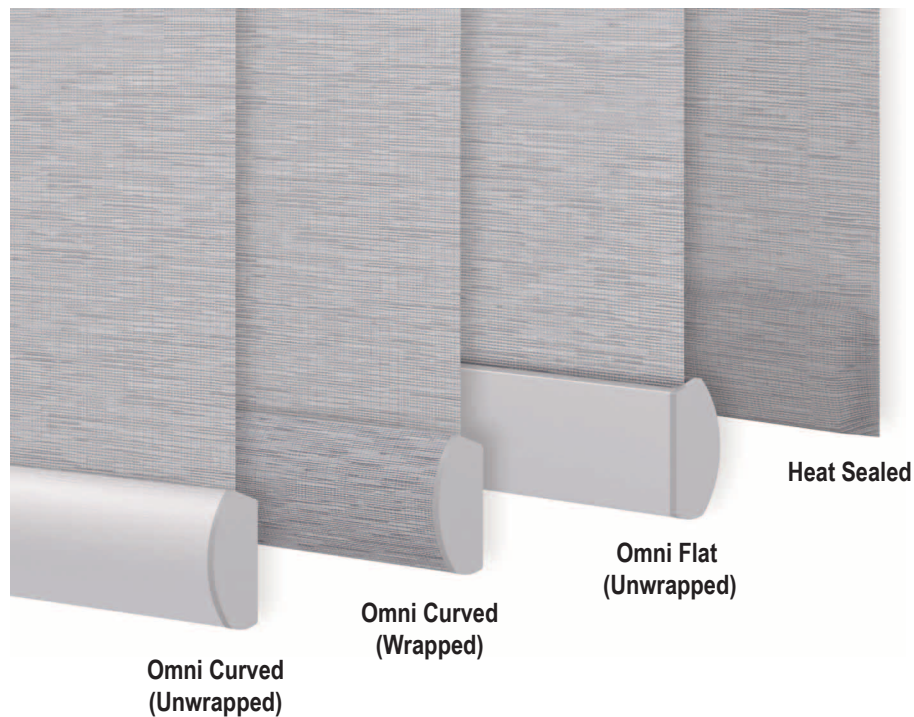

Heat Sealed Aluminum (1-1/4")

The aluminum bar is inserted and heat sealed into the hem pocket. Heat Seal Hem bar is highly recommended on bigger and wider shades made with railroaded or heavier material to improve appearance of the shades. The hem bar helps reduce waviness, twisting, cupping & curling.

Not available on all styles. Please refer to the Collection Information section.

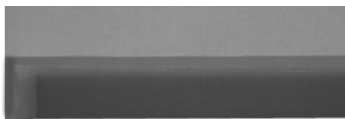

Heat sealed hem to back pocket edges come sealed

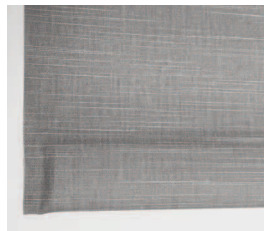

Heat sealed hem bar is highly recommended when shade is ordered with railroaded material or when shade is equal, wider than 108" or longer than 90".

Omni Bottom Rail (~1-1/8")

Available in White, Vanilla, Bronze, Black, and Silver matte finishes. Different options available as shown and listed below:

- Omni Curved Unwrapped
- Omni Flat Unwrapped
- Omni Curved Wrapped (only front face of rail is wrapped)

Bottomrail End Caps are color coordinated to the bottomrail. Changing color of the end cap is not an option.

OPTIONS

ROLL DIRECTION

When ordering, please be sure to specify **ROLL DIRECTION**

- Extended Projection Bracket
(not available with Curved Cassette and Fascia)

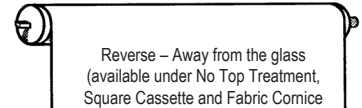
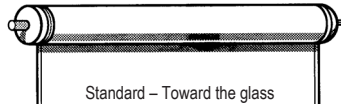

2-ON-1 OPTIONS – SPECIFY ON ORDER

- A two-on-one shade is two individual shades housed under one continuous top treatment.
- Top Treatment: Medium/Large Curved Cassette and Skyline Fascia.
- Operating System: Continuous Loop Control, Powerwand and Automation (Except Sonesse® 30 RTS 24v DC).
- Control Position: Left for left panel and right for right panel.
- Middle gap between the 2 shades is 1/2" except spring ring will be 7/8" under AC motors (Hardwired Automation). Please refer to the Product Size Specifications for individual shade sizes and Feature & Options for option availability.
 - Tolerance: Height <= 60", +1/4"; Height <=120", +3/8"; Height > 120", +1/2"
- Price as 2 separate shades added together.
- Heat sealed hem bottom rail is strongly recommended to improve the appearance of the shade. It will help minimize waviness, twisting, cupping, and curling, especially on shade greater than 108" x 90".

NOTE: There is a 1/2" gap (Continuous Loop Control & Wirefree Automation) or 7/8" gap (Hardwired Automation) between the two shades. Please refer to the **Product Size Specifications** for individual shade sizes and **Feature and Options** section for option availability.

PLASTIC STANDARD HOLD DOWN BRACKET

- Compatible with Omni Bottom Rails only
- Not recommended for Inside Mount.

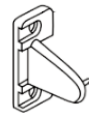

MAGNETIC HOLD DOWN BRACKET

- Available for all control systems
- Available with all bottom rail options
- Outside Mount Only
- Shade will ship with magnets attached onto the bottom rail
- Not available for reverse roll

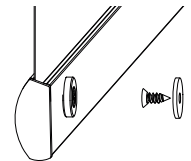

SPACER BLOCK

- Available under all operating systems with Curved and Square Cassette; IB or OB

MOTOR READY

Dealer's Own Automation

The factory will provide roller shade materials and components for Dealer or Automation Companies to motorize. These shades styles are also known to some as Motor Ready.

Motor Ready Shades:

- Motor Ready shades are **PRICED** and **MANUFACTURED** to the "net width" specified by dealer. (Dealer is required to make all necessary width deductions to allow for motor and brackets being used, and order "Outside Mount" under mount type.
- Factory automatically adds extra material length required for tube wrap at no additional charge.
- Dealer Specifies tube size. (1-1/2" and 2" at no additional charge. 2-1/2" and 3-1/4" tubes are available with applicable surcharge. (Contact customer service for surcharge information.)
- Motor Ready comes with only tube (tube without any notch), fabric and bottom rail with end caps. Clutch, idler end, crown & drive, and brackets are NOT included.

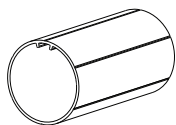

1.5" Tube

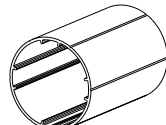

2" Wirefree Tube

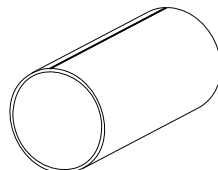

2" Hardwire Tube

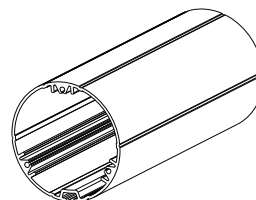

2.5" Tube

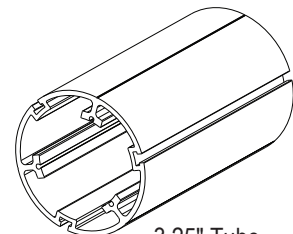

3.25" Tube

PRODUCT CHARACTERISTICS & INFORMATION

Fabric & Shade Recommendations

- To ensure color consistency and minimize dye lot variation, order all shades for the same room at the same time.
- When a shade needs to be railroaded, railroad all other shades within the same room for uniform look.
- Heat sealed hem bar is highly recommended with large shades for best shade appearance.
- Heavy shades may require some assistance to lift. Cordless Lift, Cordless shade, and PowerWand are an affordable way to replace continuous loop control and transition to a contemporary look.
- Shade over 144" in width requires motorized shade.
- Stainless Steel Chain is strongly recommended on large Continuous Loop Control operated shades.
- When ordering shades with wiring, highly recommend contacting an electrician, prior to ordering, to ensure all required/components are ordered.
- If the Somfy battery wand exceeds the width of the window opening, it will need to be mounted on the side of the wall or window trim.
- Spring assist is recommended for Continuous Loop Control shade that is over 44.4 Sq.Ft. and with shade width greater than 60"

Large Roller Shades Solutions

Most fabrics can be railroaded as an option for wider roller shades. Railroad is when material is turned 90° clockwise (using the roll length for the shade width). CBG has performed extensive testing on all fabrics at various width to ensure customers are provided with high quality shades. However, there may be some visual differences when fabric is railroaded for shades wider than 90". These differences are consider normal characteristics.

- Fabrics may curl along the edge or have slight overall waviness
- A slight V may appear in the center of the shade due to the weight of the fabric
- Tube deflection

As the above characteristics are normal and expected with very wide shades, requests for remakes and/or credits will not be considered. We suggest reducing the shade width by splitting the one wide shade to two or more individual shades.

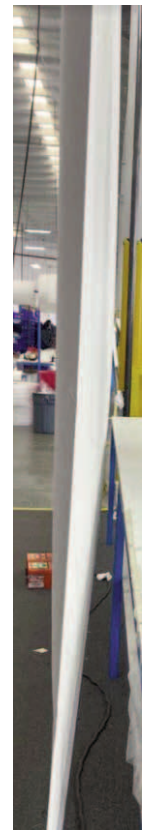
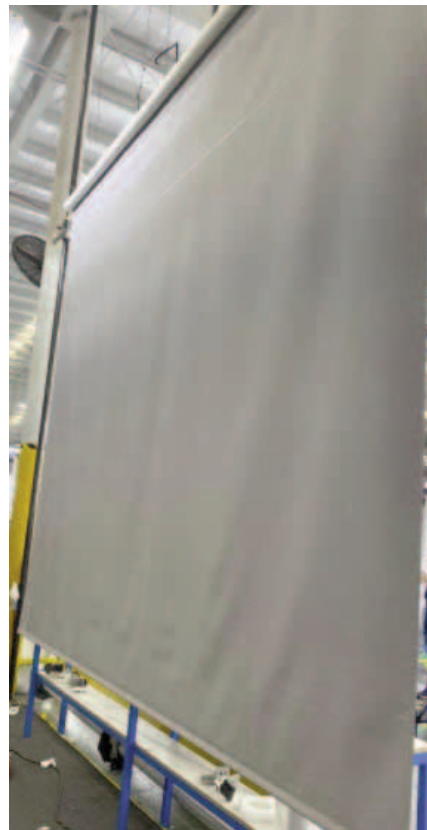

PRODUCT CHARACTERISTICS & INFORMATION

Shade Characteristics

- Inside mount shades will have light leaks at the top and around the outer edges of the shade. This is especially noticeable with blackout and room darkening materials.
- Material edges may curl inward (hourglass). This is especially noticeable on long narrow shades and shades made with railroaded fabrics.
- Minor telescoping may occur if shade is not installed exactly level.
- Privacy light block is an affordable option for added privacy and room darkening. It is not for total blackout.

Fabric Disclaimers

- Fabric appearance can vary based on changing light conditions in a room and color reflection of the interior décor.
- During transit, there may be creases in the fabric due to the time the shade rolled up in the packaging material. To remove creases, unroll the shade completely and let it hang for several days. Most wrinkles creases will resolve after several days.
- Screen material is designed to have a clear view-through when viewing directly or from a slight angle. Depending on the pattern, waviness and distortion is characteristic when viewing from an angle of approximately 30% or more.
- Please be aware that installing screen shades on windows that already feature screens may cause a moiré effect.
- Due to the nature of the weaving process, some imperfections in the weave are normal.

Pattern Alignment

- No guarantee on fabric pattern alignment for side by side shades. Under shades with cassettes, vertical alignment of the shade fabric is not possible.
- Fabric with repeat patterns are not centered on the shade.

Straighten Shade

If your shade does not roll straight, the material veers right or left, correct as follow:

Lower the shade completely to expose the roller tube. Wrap a 1-1/2" long masking tape onto the shorter side of the tube; opposite of where the material is veering. See Figure A. The tape acts as a straightener by increasing the diameter of the tube slightly. Test by raising and lowering the shade.

If the shade still do not roll straight, add a second layer of tape and repeat the process. Continue to add tape as needed until the shade rolls straight.



Scan QR code for video



FIGURE A

Cleaning and Care Information

- Periodic vacuum using an upholstery attachment when shade is dusty. Dust also can gently remove with a dusting cloth.
- Do not immerse the shade in the water. Shade may be gently clean with a damp cloth. After cleaning, keep the shade lowered to allow the shade to dry completely before raising the shade.
- Loose fibers may appear on material edges from time to time. This is normal and does not affect the overall integrity of the shade. Simply trim off the loose fibers with a pair of sharp scissors.

Installation instructions are available for your roller shades. These instructions include information on how to install shades and child safety device attachments correctly as well as instructions for shade adjustments. To ensure that all shades operate properly, we highly recommend you scan the QR code and read these instructions thoroughly and understand them before installing any Roller Shade.

PRODUCT SIZE SPECIFICATIONS - ADDITIONAL AUTOMATION INFORMATION

Hardwire Motorized Coupled Shades Information

The Motor Coupler Bracket is used on Bliss™ 10.0 AC, Sonesse 50 and Sonesse Ultra 50 RTS motors. It allows 2-3 separate shades to share a common middle bracket, with a single motor on either side to control all shades together.

Coupled Shade Limitations

- Minimum width on motor side is 35" (Bliss™ 10.0 AC), 33" (Sonesse 50) and 39" (Sonesse ULTRA 50); non-motor side is 12"
- Maximum height for each coupled shade is 144"
- Motor available only on outer shade side, left or right, and location must be specify at the time of the order.
- Gap between each section is 7/8" for Spring ring and 1/2" for Drop in.*
- Spring Rings have an adjustable height feature that helps leveling of side by side shades and eliminates telescoping
- Bliss™ 10.0 AC is not available with Drop in

Configuration	2" tube	2.5" tube	3.25" tub.	Max width	Max width per panel
Single Shade	YES	YES	YES	up to 168"	NA
Coupled Shade	YES	NO	NO	216"	120"
Single-Fascia	YES	YES	NO	144"	NA
Coupled-Fascia	YES	NO	NO	216"	120"

Spring Ring

Drop In

Open Roll Intermediate Bracket



Fascia or Pocket Intermediate Bracket

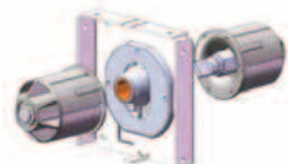

Open Roll Drop in Coupled Bracket



Drop in Fascia Pocket Bracket



2 on 1 Dimensions

Motor Bracket	Motor	Mid Gap	Idle End
Spring Ring	-13/16"	-7/8"	-7/8"
Drop in	-1 3/8"	-1/2"	-7/8"

3 on 1 Dimensions

Motor Bracket	Motor	Mid Gap	Mid Gap	Idle End
Spring Ring	-13/16"	-7/8"	-7/8"	-7/8"
Drop in	-1 3/8"	-1/2"	-1/2"	-7/8"

MOUNTING REQUIREMENTS

INSIDE MOUNT	Minimum Mounting Depth	Flush Mounting Depth
No Top Treatment	1-3/8"	2-1/8" to 4" (depending on roll diameter)
TouchLift/ Cordless Lift	1-3/8"	2-1/8" to 4" (depending on roll diameter)
Medium Curved Cassette	1-1/2"	3-3/4"
Large Curved Cassette	1-1/2"	4-3/8"
Square Cassette	1--1/2"	3-3/4"
Fabric Cornice	1"	1-1/2"
3" Fascia (R series)	2-5/8"	3-1/8"
3" Fascia (Skyline)	2-3/4"	3-1/4"
4" Fascia (R series)	3-5/8"	4-1/16"
4" Fascia (Skyline)	3-3/8"	4-3/16"
Dual Mount Skyline	2"	2" to 3-1/2" (depending on roll diameter)
Dual Mount Skyline w/ Fabric Cornice	3 - 3/4"	4 - 3/8"
Hardwire	3.25"	3-1/4" to 4-1/2" (depending on roll diameter)

OUTSIDE MOUNT	Minimum Mounting Surface Height
Continuous Loop Control	1-5/8"
Cordless Lift	1-5/8"
TouchLift Cordless	1-1/2"
Medium Curved Cassette	3-1/8"
Large Curved Cassette	4"
Square Cassette	4"
Fabric Cornice	2"
3" Fascia (R Series)	2-3/4"
3" Fascia (Skyline)	2-5/8"
4" Fascia (R Series)	3-3/4"
4" Fascia (Skyline)	2-3/4"

TWO-ON-ONE SHADE SIZE STANDARDS*	
Minimum ordered width - Cassette Valance	16"
Maximum Ordered width - Cassette Valance	144"
Maximum Height	See Spec Chart
Center Gap	1/2" *

SKYLINE FASCIA TWO-ON-ONE SHADE SIZE STANDARDS*	
Minimum ordered width - Cassette Valance	16"
Maximum Ordered width - Cassette Valance	144"
Maximum Height	See Spec Chart
Center Gap	1/2"

Each shade cannot exceed the maximum single shade size allowed for cassette (see shade size specifications)

NOTE: Cassette valances cannot be added to inside mount roller shades after they have been manufactured. They will not fit within the IB measurements.

SKYLINE FASCIA TWO-ON-ONE SHADE SIZE STANDARDS*	
Minimum ordered width - SKYLINE FASCIA	24"
Maximum Ordered width - SKYLINE FASCIA	144"
Maximum Height	See Spec Chart
Center Gap	1/2" *

*Gap Tolerance: Height <= 60", +1/4"; Height <=120", +3/8"; Height > 120", +1/2"

FINISHED DIMENSIONS

Adjustments are taken from ordered dimensions. Width and height may vary $\pm 1/8$ "

CONTINUOUS LOOP CONTROL SHADES

For all options below, Shade Height = Ordered Height

		Inside Mount	Outside Mount
Open Roll (No Top Treatment)	Shade Width	3/16 less than ordered width	Ordered Width
	Fabric & Tube Width (no end caps)	1-3/16 less than ordered width	NA
	Fabric & Tube Width (with end caps)	1-5/16 less than ordered width	1-1/8 less than ordered width
	<i>Control Side (in)</i>	11/16	9/16
	<i>Idler Side (in)</i>	1/2	7/16

Fabric Cornice	Cornice Width Tip to Tip (no returns)	3/16 less than ordered width	Ordered Width
	Cornice Width Tip to Tip (with returns)	1-3/4 greater than ordered width	1-3/4 greater than ordered width
	Fabric & Tube Width (No returns)	1-3/16 less than ordered width	1 less than ordered width
	Fabric & Tube Width (With returns)	1-3/16 less than ordered width	1 less than ordered width
	<i>Control Side (in)</i>	11/16	9/16
<i>Idler Side (in)</i>	1/2	7/16	

Square Cassette	Cassette Width	3/16 less than ordered width	Ordered Width
	Fabric & Tube Width	1-3/8 less than ordered width	1-3/16" less than ordered width
	<i>Control Side (in)</i>	7/8	3/4
	<i>Idler Side (in)</i>	1/2	7/16

Medium Curved Cassette	Cassette Width	3/16 less than ordered width	Ordered Width
	Fabric & Tube Width	1-5/16 less than ordered width	1-1/8" less than ordered width
	<i>Control Side (in)</i>	13/16	11/16
	<i>Idler Side (in)</i>	1/2	7/16

Large Curved Cassette	Cassette Width	3/16 less than ordered width	Ordered Width
	Fabric & Tube Width (Skyline)	1-5/16 less than ordered width	1-1/8" less than ordered width
	<i>Control Side (in)</i>	13/16	11/16
	<i>Idler Side (in)</i>	1/2	7/16

		Inside Mount	Outside Mount/Net Mount
3" Fascia	Fascia Width	3/16 less than ordered width	Ordered Width
	Fabric & Tube Width (no end caps)	1-3/16 less than ordered width	1" less than ordered width
	Fabric & Tube Width (with end caps)	1-3/8 less than ordered width	1-3/16 less than ordered width
	<i>Control Side (in)</i>	15/16	13/16
	<i>Idler Side (in)</i>	7/16	3/8

4" Fascia	Fascia Width	3/16 less than ordered width	Ordered Width
	Fabric & Tube Width (no end caps)	1-3/16 less than ordered width	1" less than ordered width
	Fabric & Tube Width (with end caps)	1-3/8 less than ordered width	1-3/16 less than ordered width
	<i>Control Side (in)</i>	15/16	13/16
	<i>Idler Side (in)</i>	7/16	3/8

Note:

- Fabric width + 1/4 to determine width of bottom rail with end caps. For shade with heat sealed hem bar, bottom rail width equates to fabric width
- Shade width for open roll and fabric cornice is measured from bracket end to bracket end (valance/cornice width measured separately).
- For shades with cassette, shade width is measured from cassette end cap to top treatment end cap.
- For shades with fascia ; shade width is measured from bracket end cap to end cap.

FINISHED DIMENSIONS

Adjustments are taken from ordered dimensions. Width and height may vary $\pm 1/8"$

CORDLESS LIFT

For all options below, Shade Height = Ordered Height

		Inside Mount	Outside Mount	
Open Roll (No Top Treatment)	Shade Width (no end caps)	3/16 less than ordered width	Ordered width	
	Shade Width (with end caps)	3/16 less than ordered width	Ordered width	
	Fabric/Tube Width (no end caps)	1-1/8 less than ordered width	Not Offered	
	Fabric/Tube Width (with end caps)	1-1/4 less than ordered width	1-1/16 less than ordered width	
	<i>Control Side (in)</i>	9/16"	7/16"	
	<i>Idler Side (in)</i>	11/16"	5/8"	
Fabric Cornice	Cornice Width Tip to Tip (no returns)	3/16 less than ordered width	Ordered width	
	Cornice Width Tip to Tip (with returns)	1-3/4 greater than ordered width	1-3/4 greater than ordered width	
	Fabric/Tube Width	1-1/8 less than ordered width	15/16 less than ordered width	
	<i>Control Side (in)</i>	1/2"	3/8"	
		<i>Idler Side (in)</i>	5/8"	9/16"
Square Cassette	Cassette Width	3/16 less than ordered width	Ordered width	
	Fabric/Tube Width	1 3/16 less than ordered width	1 less than ordered width	
	<i>Control Side (in)</i>	11/16"	9/16"	
		<i>Idler Side (in)</i>	1/2"	7/16"
	Medium Curved Cassette	Cassette Width	3/16 less than ordered width	Ordered width
Fabric/Tube Width		1-1/8 less than ordered width	15/16 less than ordered width	
<i>Control Side (in)</i>		5/8"	1/2"	
		<i>Idler Side (in)</i>	1/2"	7/16"
Large Curved Cassette		Cassette Width	3/16 less than ordered width	Ordered width
	Fabric/Tube Width	1-1/8 less than ordered width	15/16 less than ordered width	
	<i>Control Side (in)</i>	5/8"	1/2"	
		<i>Idler Side (in)</i>	1/2"	7/16"
	3" Fascia	Fascia Width (with end caps)	3/16 less than ordered width	Ordered width
Fascia Width (without end caps)		3/16 less than ordered width	Not Offered	
Fabric & Tube Width (with end caps)		1-5/16 less than ordered width	1-1/8" less than ordered width	
Fabric & Tube Width (without end caps)		1-1/8" less than ordered width	Not Offered	
<i>Control Side (in)</i>		9/16"	1/2"	
		<i>Idler Side (in)</i>	3/4"	5/8"
4" Fascia	Fascia Width (with end caps)	3/16 less than ordered width	Ordered width	
	Fascia Width (without end caps)	3/16 less than ordered width	Not Offered	
	Fabric & Tube Width (with end caps)	1-5/16 less than ordered width	1-1/8" less than ordered width	
	Fabric & Tube Width (without end caps)	1-1/8" less than ordered width	Not Offered	
	<i>Control Side (in)</i>	9/16"	1/2"	
		<i>Idler Side (in)</i>	3/4"	5/8"

Note:

- Fabric width + 1/4 to determine width of bottom rail with end caps. For shade with heat sealed hem bar, bottom rail width equates to fabric width
- Shade width for open roll and fabric cornice is measured from bracket end to bracket end (valance/cornice width measured separately).
- For shades with cassette, shade width is measured from cassette end cap to top treatment end cap.
- For shades with fascia ; shade width is measured from bracket end cap to end cap.

FINISHED DIMENSIONS

Adjustments are taken from ordered dimensions. Width and height may vary $\pm 1/8"$

TOUHLIFT CORDLESS SHADES

For all options below, Shade Height = Ordered Height

		Inside Mount	Outside Mount
Open Roll (No Top Treatment)	Shade Width (no end caps)	3/16 less than ordered width	Ordered width
	Shade Width (with end caps)	3/16 less than ordered width	Ordered width
	Fabric/Tube Width (no end caps)	1-1/8 less than ordered width	Not Offered
	Fabric/Tube Width (with end caps)	1-1/4 less than ordered width	1-1/16 less than ordered width
	<i>Control Side (in)</i>	9/16"	7/16"
	<i>Idler Side (in)</i>	11/16"	5/8"
Fabric Cornice	Cornice Width Tip to Tip (no returns)	3/16 less than ordered width	Ordered width
	Cornice Width Tip to Tip (with returns)	1-3/4 greater than ordered width	1-3/4 greater than ordered width
	Fabric/Tube Width	1-1/8 less than ordered width	15/16 less than ordered width
	<i>Control Side (in)</i>	1/2"	3/8"
	<i>Idler Side (in)</i>	5/8"	9/16"
Square Cassette	Cassette Width	3/16 less than ordered width	Ordered width
	Fabric/Tube Width	1 3/16 less than ordered width	1 less than ordered width
	<i>Control Side (in)</i>	11/16"	9/16"
	<i>Idler Side (in)</i>	1/2"	7/16"
Medium Curved Cassette	Cassette Width	3/16 less than ordered width	Ordered width
	Fabric/Tube Width	1-1/8 less than ordered width	15/16 less than ordered width
	<i>Control Side (in)</i>	5/8"	1/2"
	<i>Idler Side (in)</i>	1/2"	7/16"
Large Curved	Cassette Width	3/16 less than ordered width	Ordered width
	Fabric/Tube Width	1-1/8 less than ordered width	15/16 less than ordered width
	<i>Control Side (in)</i>	5/8"	1/2"
	<i>Idler Side (in)</i>	1/2"	7/16"
3" Fascia	Fascia Width (with end caps)	3/16 less than ordered width	Ordered width
	Fascia Width (without end caps)	3/16 less than ordered width	Not Offered
	Fabric & Tube Width (with end caps)	1-5/16 less than ordered width	1-1/8" less than ordered width
	Fabric & Tube Width (without end caps)	1-1/8" less than ordered width	Not Offered
	<i>Control Side (in)</i>	9/16"	1/2"
	<i>Idler Side (in)</i>	3/4"	5/8"
4" Fascia	Fascia Width (with end caps)	3/16 less than ordered width	Ordered width
	Fascia Width (without end caps)	3/16 less than ordered width	Not Offered
	Fabric & Tube Width (with end caps)	1-5/16 less than ordered width	1-1/8" less than ordered width
	Fabric & Tube Width (without end caps)	1-1/8" less than ordered width	Not Offered
	<i>Control Side (in)</i>	9/16"	1/2"
	<i>Idler Side (in)</i>	3/4"	5/8"

Note:

- Fabric width + 1/4 to determine width of bottom rail with end caps. For shade with heat sealed hem bar, bottom rail width equates to fabric width
- Shade width for open roll and fabric cornice is measured from bracket end to bracket end (valance/cornice width measured separately).
- For shades with cassette, shade width is measured from cassette end cap to top treatment end cap.
- For shades with fascia ; shade width is measured from bracket end cap to end cap.

FINISHED DIMENSIONS

Adjustments are taken from ordered dimensions. Width and height may vary $\pm 1/8"$

POWERWAND™

Powerwand 1.0 Li-Ion*

Powerwand 2.0 Li-Ion*

1 1/2" and 2" Tube

For all options below, Shade Height = Ordered Height

		Inside Mount	Outside Mount
Open Roll (No Top Treatment)	Shade Width	3/16 less than ordered width	Ordered Width
	Fabric & Tube Width (no end caps)	1-5/16 less than ordered width	1-1/8 less than ordered width
	Fabric & Tube Width (with end caps)	1-7/16 less than ordered width	1-1/4 less than ordered width
	<i>Control Side (in)</i>	13/16	11/16
	<i>Idler Side (in)</i>	1/2	7/16

Fabric Cornice	Cornice Width Tip to Tip (no returns)	3/16 less than ordered width	Ordered Width
	Cornice Width Tip to Tip (with returns)	1-3/4 greater than ordered width	1-3/4 greater than ordered width
	Fabric & Tube Width (no returns)	1-5/16 less than ordered width	1-1/8 less than ordered width
	Fabric & Tube Width (with returns)	1-5/16 less than ordered width	1-1/8 less than ordered width
	<i>Control Side (in)</i>	13/16	11/16
<i>Idler Side (in)</i>	1/2	7/16	

Square Cassette	Cassette Width	3/16 less than ordered width	Ordered Width
	Fabric & Tube Width (with end caps)	1-7/16 less than ordered width	1-1/4" less than ordered width
	<i>Control Side (in)</i>	15/16	13/16
	<i>Idler Side (in)</i>	1/2	7/16

Medium Curved Cassette	Cassette Width	3/16 less than ordered width	Ordered Width
	Fabric & Tube Width (with end caps)	1-7/16 less than ordered width	1-1/4" less than ordered width
	<i>Control Side (in)</i>	15/16	13/16
	<i>Idler Side (in)</i>	1/2	7/16

Large Curved Cassette	Cassette Width	3/16 less than ordered width	Ordered Width
	Fabric & Tube Width (with end caps)	1-7/16 less than ordered width	1-1/4" less than ordered width
	<i>Control Side (in)</i>	15/16	13/16
	<i>Idler Side (in)</i>	1/2	7/16

3" Fascia	Fascia Width	3/16 less than ordered width	Ordered Width
	Fabric & Tube Width (No end caps)	1-5/16 less than ordered width	1-1/8 less than ordered width
	Fabric & Tube Width (With end caps)	1-1/2 less than ordered width	1-5/16" less than ordered width
	<i>Control Side (in)</i>	7/8	13/16
	<i>Idler Side (in)</i>	5/8	1/2

*Not available with Powerwand

4" Fascia	Fascia Width	3/16 less than ordered width	Ordered Width
	Fabric & Tube Width (No end caps)	1-5/16 less than ordered width	1-1/8 less than ordered width
	Fabric & Tube Width (With end caps)	1-3/8 less than ordered width	1-3/16" less than ordered width
	<i>Control Side (in)</i>	7/8	3/4
	<i>Idler Side (in)</i>	1/2	7/16

Note:

- Fabric width + 1/4 to determine width of bottom rail with end caps. For shade with heat sealed hem bar, bottom rail width equates to fabric width
- Shade width for open roll and fabric cornice is measured from bracket end to bracket end (valance/cornice width measured separately).
- For shades with cassette, shade width is measured from cassette end cap to top treatment end cap.
- For shades with fascia ; shade width is measured from bracket end cap to end cap.

FINISHED DIMENSIONS

Adjustments are taken from ordered dimensions. Width and height may vary $\pm 1/8$ "

BLISS AUTOMATION

"Bliss™ 1.1 DC
Bliss™ 1.1 Li-Ion
Bliss™ 2.0 DC
Bliss™ 2.0 Li-Ion"

1 1/2" and 2" Tube

For all options below, Shade Height = Ordered Height

		Inside Mount	Outside Mount
Open Roll (No Top Treatment)	Shade Width	3/16 less than ordered width	Ordered Width
	Fabric & Tube Width (no end caps)	1-5/16 less than ordered width	1-1/8 less than ordered width
	Fabric & Tube Width (with end caps)	1-7/16 less than ordered width	1-1/4 less than ordered width
	<i>Control Side (in)</i>	13/16	11/16
	<i>Idler Side (in)</i>	1/2	7/16
Fabric Cornice	Cornice Width Tip to Tip (no returns)	3/16 less than ordered width	Ordered Width
	Cornice Width Tip to Tip (with returns)	1-3/4 greater than ordered width	1-3/4 greater than ordered width
	Fabric & Tube Width (no returns)	1-5/16 less than ordered width	1-1/8 less than ordered width
	Fabric & Tube Width (with returns)	1-5/16 less than ordered width	1-1/8 less than ordered width
	<i>Control Side (in)</i>	13/16	11/16
<i>Idler Side (in)</i>	1/2	7/16	
Square Cassette	Cassette Width	3/16 less than ordered width	Ordered Width
	Fabric & Tube Width (with end caps)	1-7/16 less than ordered width	1-1/4" less than ordered width
	<i>Control Side (in)</i>	15/16	13/16
	<i>Idler Side (in)</i>	1/2	7/16
Medium Curved Cassette	Cassette Width	3/16 less than ordered width	Ordered Width
	Fabric & Tube Width (with end caps)	1-7/16 less than ordered width	1-1/4" less than ordered width
	<i>Control Side (in)</i>	15/16	13/16
	<i>Idler Side (in)</i>	1/2	7/16
Large Curved Cassette	Cassette Width	3/16 less than ordered width	Ordered Width
	Fabric & Tube Width (with end caps)	1-7/16 less than ordered width	1-1/4" less than ordered width
	<i>Control Side (in)</i>	15/16	13/16
	<i>Idler Side (in)</i>	1/2	7/16
3" Fascia	Fascia Width	3/16 less than ordered width	Ordered Width
	Fabric & Tube Width (No end caps)	1-5/16 less than ordered width	1-1/8 less than ordered width
	Fabric & Tube Width (With end caps)	1-1/2 less than ordered width	1-5/16" less than ordered width
	<i>Control Side (in)</i>	7/8	13/16
	<i>Idler Side (in)</i>	5/8	1/2
4" Fascia	Fascia Width	3/16 less than ordered width	Ordered Width
	Fabric & Tube Width (No end caps)	1-5/16 less than ordered width	1-1/8 less than ordered width
	Fabric & Tube Width (With end caps)	1-3/8 less than ordered width	1-3/16" less than ordered width
	<i>Control Side (in)</i>	7/8	3/4
	<i>Idler Side (in)</i>	1/2	7/16

Note:

- Fabric width + 1/4 to determine width of bottom rail with end caps. For shade with heat sealed hem bar, bottom rail width equates to fabric width
- Shade width for open roll and fabric cornice is measured from bracket end to bracket end (valance/cornice width measured separately).
- For shades with cassette, shade width is measured from cassette end cap to top treatment end cap.
- For shades with fascia ; shade width is measured from bracket end cap to end cap.

FINISHED DIMENSIONS

Adjustments are taken from ordered dimensions. Width and height may vary $\pm 1/8"$

BLISS AUTOMATION

Bliss™ 3.0 Li-Ion

Bliss™ 10.0 AC

with 2" Tube

For all options below, Shade Height = Ordered Height

Note: Bliss™ 10.0 AC is only available with Open Roll and 4" Fascia refer spec page for details

		Inside Mount	Outside Mount
Open Roll (No Top Treatment)	Shade Width	3/16 less than ordered width	Ordered Width
	Fabric & Tube Width (no end caps)	1-7/16 less than ordered width	1-1/4 less than ordered width
	Fabric & Tube Width (with end caps)	1-9/16 less than ordered width	1-3/8 less than ordered width
	<i>Control Side (in)</i>	15/16	13/16
	<i>Idler Side (in)</i>	1/2	7/16
Fabric Cornice	Cornice Width Tip to Tip (no returns)	3/16 less than ordered width	Ordered Width
	Cornice Width Tip to Tip (with returns)	1-3/4 greater than ordered width	1-3/4 greater than ordered width
	Fabric & Tube Width (no returns)	1-7/16 less than ordered width	1-1/4 less than ordered width
	Fabric & Tube Width (with returns)	1-7/16 less than ordered width	1-1/4 less than ordered width
	<i>Control Side (in)</i>	15/16	13/16
<i>Idler Side (in)</i>	1/2	7/16	
Square Cassette	Cassette Width	3/16 less than ordered width	Ordered Width
	Fabric & Tube Width (with end caps)	1-9/16 less than ordered width	1-3/8" less than ordered width
	<i>Control Side (in)</i>	1 1/16	15/16
	<i>Idler Side (in)</i>	1/2	7/16
Medium Curved Cassette	Cassette Width	3/16 less than ordered width	Ordered Width
	Fabric & Tube Width (with end caps)	1-9/16 less than ordered width	1-3/8" less than ordered width
	<i>Control Side (in)</i>	1 1/16	15/16
	<i>Idler Side (in)</i>	1/2	7/16
Large Curved Cassette	Cassette Width	3/16 less than ordered width	Ordered Width
	Fabric & Tube Width (with end caps)	1-9/16 less than ordered width	1-3/8" less than ordered width
	<i>Control Side (in)</i>	1 1/16	15/16
	<i>Idler Side (in)</i>	1/2	7/16
3" Fascia	Fascia Width	3/16 less than ordered width	Ordered Width
	Fabric & Tube Width (No end caps)	1-7/16 less than ordered width	1-1/4" less than ordered width
	Fabric & Tube Width (With end caps)	1-5/8 less than ordered width	1-7/16" less than ordered width
	<i>Control Side (in)</i>	1	15/16
	<i>Idler Side (in)</i>	5/8	1/2
4" Fascia	Fascia Width	3/16 less than ordered width	Ordered Width
	Fabric & Tube Width (No end caps)	1-7/16 less than ordered width	1-1/4" less than ordered width
	Fabric & Tube Width (With end caps)	1-1/2 less than ordered width	1-5/16" less than ordered width
	<i>Control Side (in)</i>	1	7/8
	<i>Idler Side (in)</i>	1/2	7/16

Note:

- Fabric width + 1/4 to determine width of bottom rail with end caps. For shade with heat sealed hem bar, bottom rail width equates to fabric width
- Shade width for open roll and fabric cornice is measured from bracket end to bracket end (valance/cornice width measured separately).
- For shades with cassette, shade width is measured from cassette end cap to top treatment end cap.
- For shades with fascia ; shade width is measured from bracket end cap to end cap.

FINISHED DIMENSIONS

Adjustments are taken from ordered dimensions. Width and height may vary $\pm 1/8$ "

BLISS AUTOMATION

Bliss™ 3.0 Li-Ion

Bliss™ 10.0 AC

with 2-1/2" Tube

Note: Bliss™ 10.0 is only available with Open Roll and 4" Fascia, refer spec page for details

		Inside Mount	Outside Mount
Open Roll (No Top Treatment)	Shade Width	3/16 less than ordered width	Ordered Width
	Fabric & Tube Width (no end caps)	1-5/8 less than ordered width	1-7/16 less than ordered width
	Fabric & Tube Width (with end caps)	1-3/4 less than ordered width	1-9/16 less than ordered width
	<i>Control Side (in)</i>	1 1/16	15/16
	<i>Idler Side (in)</i>	9/16	1/2
Fabric Cornice	Cornice Width Tip to Tip (no returns)	3/16 less than ordered width	Ordered Width
	Cornice Width Tip to Tip (with returns)	1-3/4 greater than ordered width	1-3/4 greater than ordered width
	Fabric & Tube Width (no returns)	1-5/8 less than ordered width	1-7/16 less than ordered width
	Fabric & Tube Width (with returns)	1-5/8 less than ordered width	1-7/16 less than ordered width
	<i>Idler Side (in)</i>	9/16	1/2
Square Cassette	Cassette Width	3/16 less than ordered width	Ordered Width
	Fabric & Tube Width (with end caps)	1-7/8 less than ordered width	1-11/16 less than ordered width
	<i>Control Side (in)</i>	1 3/16	1 1/8
	<i>Idler Side (in)</i>	11/16	9/16
	Medium Curved Cassette	Cassette Width	3/16 less than ordered width
Fabric & Tube Width (with end caps)		1-7/8 less than ordered width	1-11/16 less than ordered width
<i>Control Side (in)</i>		1 3/16	1 1/8
<i>Idler Side (in)</i>		11/16	9/16
Large Curved Cassette		Cassette Width	3/16 less than ordered width
	Fabric & Tube Width (with end caps)	1-7/8 less than ordered width	1-11/16 less than ordered width
	<i>Control Side (in)</i>	1 3/16	1 1/8
	<i>Idler Side (in)</i>	11/16	9/16
	3" Fascia	Fascia Width	3/16 less than ordered width
Fabric & Tube Width (No end caps)		1-5/8 less than ordered width	1-7/16 less than ordered width
Fabric & Tube Width (With end caps)		1-13/16 less than ordered width	1-5/8" less than ordered width
<i>Control Side (in)</i>		1 3/16	1 1/8
<i>Idler Side (in)</i>		5/8	1/2
4" Fascia	Fascia Width	3/16 less than ordered width	Ordered Width
	Fabric & Tube Width (No end caps)	1-5/8 less than ordered width	1-7/16 less than ordered width
	Fabric & Tube Width (With end caps)	1-11/16 less than ordered width	1-1/2 less than ordered width
	<i>Control Side (in)</i>	1 3/16	1 1/8
	<i>Idler Side (in)</i>	2-Jan	16-Jul

Note:

- Fabric width + 1/4 to determine width of bottom rail with end caps. For shade with heat sealed hem bar, bottom rail width equates to fabric width
- Shade width for open roll and fabric cornice is measured from bracket end to bracket end (valance/cornice width measured separately).
- For shades with cassette, shade width is measured from cassette end cap to top treatment end cap.
- For shades with fascia ; shade width is measured from bracket end cap to end cap.

FINISHED DIMENSIONS

Adjustments are taken from ordered dimensions. Width and height may vary $\pm 1/8$ "

BLISS AUTOMATION

Bliss™ 3.0 Li-Ion

Bliss™ 10.0 AC

3-1/4" Tube

Bliss™ 3.0 Li-Ion

	Inside Mount		Outside Mount / Net Mount
	Shade Width	3/16 less than ordered width	Ordered Width
Open Roll (No Top Treatment)	Fabric & Tube Width (no end caps)	2" less than ordered width	1-13/16" less than ordered width
	Fabric & Tube Width (with end caps)	2-1/8" less than ordered width	1-15/16" less than ordered width
	Control Side (in)	1	15/16
	Idler Side (in)	1	7/8

Bliss™ 10.0 AC

	Inside Mount		Outside Mount / Net Mount
	Shade Width	3/16 less than ordered width	Ordered Width
Open Roll (No Top Treatment)	Fabric & Tube Width (no end caps)	2-7/16 less than ordered width	2-1/4" less than ordered width
	Fabric & Tube Width (with end caps)	2-9/16 less than ordered width	2-3/8" less than ordered width
	Control Side (in)	1 7/16	1 3/8
	Idler Side (in)	1	7/8

Note:

- Fabric width + 1/4 to determine width of bottom rail with end caps. For shade with heat sealed hem bar, bottom rail width equates to fabric width
- Shade width for open roll, deluxe valance and fabric cornice is measured from bracket end to bracket end (valance/cornice width measured separately).
- For shades with fascia or pocket; shade width is measured from bracket end cap to bracket end cap.
- * **Outside Mount Pocket is referring to Ceiling Mount (not for flat wall mount)**

FINISHED DIMENSIONS

Adjustments are taken from ordered dimensions. Width and height may vary $\pm 1/8"$

SOMFY AUTOMATION

Sonesse® 28 WireFree™ RTS Li-Ion / Sonesse® 28 WireFree™ Zigbee Li-Ion

Sonesse® 28 WireFree™ RTS DC / Sonesse® 28 WireFree™ Zigbee DC

Sonesse® ULTRA 30 WireFree™ RTS Li-Ion

Sonesse® 30 RTS 24v DC

1 1/2" and 2" Tube

For all options below, Shade Height = Ordered Height

		Inside Mount	Outside Mount
Open Roll (No Top Treatment)	Shade Width	3/16 less than ordered width	Ordered Width
	Fabric & Tube Width (no end caps)	1-5/16 less than ordered width	1-1/8 less than ordered width
	Fabric & Tube Width (with end caps)	1-7/16 less than ordered width	1-1/4 less than ordered width
	<i>Control Side (in)</i>	13/16	11/16
	<i>Idler Side (in)</i>	1/2	7/16

Fabric Cornice	Cornice Width Tip to Tip (no returns)	3/16 less than ordered width	Ordered Width
	Cornice Width Tip to Tip (with returns)	1-3/4 greater than ordered width	1-3/4 greater than ordered width
	Fabric & Tube Width (no returns)	1-5/16 less than ordered width	1-1/8 less than ordered width
	Fabric & Tube Width (with returns)	1-5/16 less than ordered width	1-1/8 less than ordered width
	<i>Control Side (in)</i>	13/16	11/16
<i>Idler Side (in)</i>	1/2	7/16	

Square Cassette	Cassette Width	3/16 less than ordered width	Ordered Width
	Fabric & Tube Width (with end caps)	1-7/16 less than ordered width	1-1/4" less than ordered width
	<i>Control Side (in)</i>	15/16	13/16
	<i>Idler Side (in)</i>	1/2	7/16

Medium Curved Cassette	Cassette Width	3/16 less than ordered width	Ordered Width
	Fabric & Tube Width (with end caps)	1-7/16 less than ordered width	1-1/4" less than ordered width
	<i>Control Side (in)</i>	15/16	13/16
	<i>Idler Side (in)</i>	1/2	7/16

Large Curved Cassette	Cassette Width	3/16 less than ordered width	Ordered Width
	Fabric & Tube Width (with end caps)	1-7/16 less than ordered width	1-1/4" less than ordered width
	<i>Control Side (in)</i>	15/16	13/16
	<i>Idler Side (in)</i>	1/2	7/16

3" Fascia	Fascia Width	3/16 less than ordered width	Ordered Width
	Fabric & Tube Width (No end caps)	1-5/16 less than ordered width	1-1/8 less than ordered width
	Fabric & Tube Width (With end caps)	1-1/2 less than ordered width	1-5/16" less than ordered width
	<i>Control Side (in)</i>	7/8	13/16
	<i>Idler Side (in)</i>	5/8	1/2

4" Fascia	Fascia Width	3/16 less than ordered width	Ordered Width
	Fabric & Tube Width (No end caps)	1-5/16 less than ordered width	1-1/8 less than ordered width
	Fabric & Tube Width (With end caps)	1-3/8 less than ordered width	1-3/16" less than ordered width
	<i>Control Side (in)</i>	7/8	3/4
	<i>Idler Side (in)</i>	1/2	7/16

Note:

- Fabric width + 1/4 to determine width of bottom rail with end caps. For shade with heat sealed hem bar, bottom rail width equates to fabric width
- Shade width for open roll and fabric cornice is measured from bracket end to bracket end (valance/cornice width measured separately).
- For shades with cassette, shade width is measured from cassette end cap to top treatment end cap.
- For shades with fascia ; shade width is measured from bracket end cap to end cap.

FINISHED DIMENSIONS

Adjustments are taken from ordered dimensions. Width and height may vary $\pm 1/8"$

SOMFY AUTOMATION

Sonesse® 40 WireFree™ RTS Li-Ion

2" Tube

For all options below, Shade Height = Ordered Height

		Inside Mount	Outside Mount
Open Roll (No Top Treatment)	Shade Width	3/16 less than ordered width	Ordered Width
	Fabric & Tube Width (no end caps)	1-7/16 less than ordered width	1-1/4 less than ordered width
	Fabric & Tube Width (with end caps)	1-9/16 less than ordered width	1-3/8 less than ordered width
	<i>Control Side (in)</i>	15/16	13/16
	<i>Idler Side (in)</i>	1/2	7/16
Fabric Cornice	Cornice Width Tip to Tip (no returns)	3/16 less than ordered width	Ordered Width
	Cornice Width Tip to Tip (with returns)	1-3/4 greater than ordered width	1-3/4 greater than ordered width
	Fabric & Tube Width (no returns)	1-7/16 less than ordered width	1-1/4 less than ordered width
	Fabric & Tube Width (with returns)	1-7/16 less than ordered width	1-1/4 less than ordered width
	<i>Control Side (in)</i>	15/16	13/16
<i>Idler Side (in)</i>	1/2	7/16	
Square Cassette	Cassette Width	3/16 less than ordered width	Ordered Width
	Fabric & Tube Width (with end caps)	1-9/16 less than ordered width	1-3/8" less than ordered width
	<i>Control Side (in)</i>	1 1/16	15/16
	<i>Idler Side (in)</i>	1/2	7/16
Medium Curved Cassette	Cassette Width	3/16 less than ordered width	Ordered Width
	Fabric & Tube Width (with end caps)	1-9/16 less than ordered width	1-3/8" less than ordered width
	<i>Control Side (in)</i>	1 1/16	15/16
	<i>Idler Side (in)</i>	1/2	7/16
Large Curved Cassette	Cassette Width	3/16 less than ordered width	Ordered Width
	Fabric & Tube Width (with end caps)	1-9/16 less than ordered width	1-3/8" less than ordered width
	<i>Control Side (in)</i>	1 1/16	15/16
	<i>Idler Side (in)</i>	1/2	7/16
3" Fascia	Fascia Width	3/16 less than ordered width	Ordered Width
	Fabric & Tube Width (No end caps)	1-7/16 less than ordered width	1-1/4" less than ordered width
	Fabric & Tube Width (With end caps)	1-5/8 less than ordered width	1-7/16" less than ordered width
	<i>Control Side (in)</i>	1	15/16
	<i>Idler Side (in)</i>	5/8	1/2
4" Fascia	Fascia Width	3/16 less than ordered width	Ordered Width
	Fabric & Tube Width (No end caps)	1-7/16 less than ordered width	1-1/4" less than ordered width
	Fabric & Tube Width (With end caps)	1-1/2 less than ordered width	1-5/16" less than ordered width
	<i>Control Side (in)</i>	1	7/8
	<i>Idler Side (in)</i>	1/2	7/16

Note:

- Fabric width + 1/4 to determine width of bottom rail with end caps. For shade with heat sealed hem bar, bottom rail width equates to fabric width
- Shade width for open roll and fabric cornice is measured from bracket end to bracket end (valance/cornice width measured separately).
- For shades with cassette, shade width is measured from cassette end cap to top treatment end cap.
- For shades with fascia ; shade width is measured from bracket end cap to end cap.

FINISHED DIMENSIONS

Adjustments are taken from ordered dimensions. Width and height may vary $\pm 1/8"$

SOMFY AUTOMATION Sonesse® 40 WireFree™ RTS Li-Ion

with 2-1/2" Tube

		Inside Mount	Outside Mount
Open Roll (No Top Treatment)	Shade Width	3/16 less than ordered width	Ordered Width
	Fabric & Tube Width (no end caps)	1-5/8 less than ordered width	1-7/16 less than ordered width
	Fabric & Tube Width (with end caps)	1-3/4 less than ordered width	1-9/16 less than ordered width
	<i>Control Side (in)</i>	1 1/16	15/16
	<i>Idler Side (in)</i>	9/16	1/2
Fabric Cornice	Cornice Width Tip to Tip (no returns)	3/16 less than ordered width	Ordered Width
	Cornice Width Tip to Tip (with returns)	1-3/4 greater than ordered width	1-3/4 greater than ordered width
	Fabric & Tube Width (no returns)	1-5/8 less than ordered width	1-7/16 less than ordered width
	Fabric & Tube Width (with returns)	1-5/8 less than ordered width	1-7/16 less than ordered width
	<i>Control Side (in)</i>	1 1/16	15/16
<i>Idler Side (in)</i>	9/16	1/2	
Square Cassette	Cassette Width	3/16 less than ordered width	Ordered Width
	Fabric & Tube Width (with end caps)	1-7/8 less than ordered width	1-11/16 less than ordered width
	<i>Control Side (in)</i>	1 3/16	1 1/8
	<i>Idler Side (in)</i>	11/16	9/16
Medium Curved Cassette	Cassette Width	3/16 less than ordered width	Ordered Width
	Fabric & Tube Width (with end caps)	1-7/8 less than ordered width	1-11/16 less than ordered width
	<i>Control Side (in)</i>	1 3/16	1 1/8
	<i>Idler Side (in)</i>	11/16	9/16
Large Curved Cassette	Cassette Width	3/16 less than ordered width	Ordered Width
	Fabric & Tube Width (with end caps)	1-7/8 less than ordered width	1-11/16 less than ordered width
	<i>Control Side (in)</i>	1 3/16	1 1/8
	<i>Idler Side (in)</i>	11/16	9/16
3" Fascia	Fascia Width	3/16 less than ordered width	Ordered Width
	Fabric & Tube Width (No end caps)	1-5/8 less than ordered width	1-7/16 less than ordered width
	Fabric & Tube Width (With end caps)	1-13/16 less than ordered width	1-5/8" less than ordered width
	<i>Control Side (in)</i>	1 3/16	1 1/8
	<i>Idler Side (in)</i>	5/8	1/2
4" Fascia	Fascia Width	3/16 less than ordered width	Ordered Width
	Fabric & Tube Width (No end caps)	1-5/8 less than ordered width	1-7/16 less than ordered width
	Fabric & Tube Width (With end caps)	1-11/16 less than ordered width	1-1/2 less than ordered width
	<i>Control Side (in)</i>	1.1875	1 1/8
	<i>Idler Side (in)</i>	1/2	7/16

Note:

- Fabric width + 1/4 to determine width of bottom rail with end caps. For shade with heat sealed hem bar, bottom rail width equates to fabric width
- Shade width for open roll and fabric cornice is measured from bracket end to bracket end (valance/cornice width measured separately).
- For shades with cassette, shade width is measured from cassette end cap to top treatment end cap.
- For shades with fascia ; shade width is measured from bracket end cap to end cap.

FINISHED DIMENSIONS

Adjustments are taken from ordered dimensions. Width and height may vary $\pm 1/8"$

SOMFY AUTOMATION

Sonesse® 30 RTS 24v DC

1-1/2" Tube

For all options below, Shade Height = Ordered Height

		Inside Mount	Outside Mount
Open Roll (No Top Treatment)	Shade Width	3/16 less than ordered width	Ordered Width
	Fabric & Tube Width (no end caps)	1-3/16 less than ordered width	1" less than ordered width
	Fabric & Tube Width (with end caps)	1-5/16 less than ordered width	1-1/8" less than ordered width
	<i>Control Side (in)</i>	11/16	9/16
	<i>Idler Side (in)</i>	1/2	7/16
Fabric Cornice	Cornice Width Tip to Tip (no returns)	3/16 less than ordered width	Ordered Width
	Cornice Width Tip to Tip (with returns)	1-3/4 greater than ordered width	1-3/4 greater than ordered width
	Fabric & Tube Width (no returns)	1-3/16 less than ordered width	1 less than ordered width
	Fabric & Tube Width (with returns)	1-3/16 less than ordered width	1" less than ordered width
	<i>Control Side (in)</i>	11/16	9/16
<i>Idler Side (in)</i>	1/2	7/16	
Square Cassette	Cassette Width	3/16 less than ordered width	Ordered Width
	Fabric & Tube Width (with end caps)	1-5/16 less than ordered width	1-3/8" less than ordered width
	<i>Control Side (in)</i>	13/16	11/16
	<i>Idler Side (in)</i>	1/2	7/16
Medium Curved Cassette	Cassette Width	3/16 less than ordered width	Ordered Width
	Fabric & Tube Width (with end caps)	1-5/16 less than ordered width	1-3/8" less than ordered width
	<i>Control Side (in)</i>	13/16	11/16
	<i>Idler Side (in)</i>	1/2	7/16
Large Curved Cassette	Cassette Width	3/16 less than ordered width	Ordered Width
	Fabric & Tube Width (with end caps)	1-5/16 less than ordered width	1-3/8" less than ordered width
	<i>Control Side (in)</i>	13/16	11/16
	<i>Idler Side (in)</i>	1/2	7/16
3" Fascia	Fascia Width	3/16 less than ordered width	Ordered Width
	Fabric & Tube Width (No end caps)	1-3/16 less than ordered width	1 less than ordered width
	Fabric & Tube Width (With end caps)	1-3/8 less than ordered width	1-3/16" less than ordered width
	<i>Control Side (in)</i>	13/16	11/16
	<i>Idler Side (in)</i>	9/16	1/2
4" Fascia	Fascia Width	3/16 less than ordered width	Ordered Width
	Fabric & Tube Width (No end caps)	1-3/16 less than ordered width	1 less than ordered width
	Fabric & Tube Width (With end caps)	1-1/4 less than ordered width	1-1/16 less than ordered width
	<i>Control Side (in)</i>	3/4	5/8
	<i>Idler Side (in)</i>	1/2	7/16

Note:

- Fabric width + 1/4 to determine width of bottom rail with end caps. For shade with heat sealed hem bar, bottom rail width equates to fabric width
- Shade width for open roll and fabric cornice is measured from bracket end to bracket end (valance/cornice width measured separately).
- For shades with cassette, shade width is measured from cassette end cap to top treatment end cap.
- For shades with fascia ; shade width is measured from bracket end cap to end cap.

FINISHED DIMENSIONS

Adjustments are taken from ordered dimensions. Width and height may vary $\pm 1/8$ "

SOMFY AUTOMATION

Sonesse® 50 RTS

Sonesse® ULTRA 50 AC

2" Tube

Spring Ring

		Inside Mount	Outside Mount / Net Mount
Open Roll (No Top Treatment)	Shade Width	3/16 less than ordered width	Ordered Width
	Fabric & Tube Width (no end caps)	1-7/8 less than ordered width	1-11/16" less than ordered width
	Fabric & Tube Width (with end caps)	2 less than ordered width	1-13/16" less than ordered width
	<i>Control Side</i> (in)	15/16	13/16
	<i>Idler Side</i> (in)	15/16	7/8
4" Fascia (R-Series)	Fascia Width	3/16 less than ordered width	Ordered Width
	Fabric & Tube Width (no end caps)	1-7/8 less than ordered width	1-11/16" less than ordered width
	Fabric & Tube Width (with end caps)	1-15/16 less than ordered width	1-3/4" less than ordered width
	<i>Control Side</i> (in)	1	7/8
	<i>Idler Side</i> (in)	15/16	7/8

SOMFY AUTOMATION

Sonesse® 50 RTS

Sonesse® ULTRA 50 AC

2" Tube

Drop In

		Inside Mount	Outside Mount / Net Mount
Open Roll (No Top Treatment)	Shade Width	3/16 less than ordered width	Ordered Width
	Fabric & Tube Width (no end caps)	2-7/16 less than ordered width	2-1/4" less than ordered width
	Fabric & Tube Width (with end caps)	2-9/16 less than ordered width	2-3/8" less than ordered width
	<i>Control Side</i> (in)	1 7/16	1 3/8
	<i>Idler Side</i> (in)	1	7/8
4" Fascia (R-Series)	Fascia Width	3/16 less than ordered width	Ordered Width
	Fabric & Tube Width (no end caps)	2-7/16 less than ordered width	2-1/4" less than ordered width
	Fabric & Tube Width (with end caps)	2-1/2 less than ordered width	2-5/16" less than ordered width
	<i>Control Side</i> (in)	1 7/16	1 3/8
	<i>Idler Side</i> (in)	1	7/8

Note:

- Fabric width + 1/4 to determine width of bottom rail with end caps. For shade with heat sealed hem bar, bottom rail width equates to fabric width
- Shade width for open roll and fabric cornice is measured from bracket end to bracket end (valance/cornice width measured separately).
- For shades with cassette, shade width is measured from cassette end cap to top treatment end cap.
- For shades with fascia ; shade width is measured from bracket end cap to end cap.

FINISHED DIMENSIONS

Adjustments are taken from ordered dimensions. Width and height may vary $\pm 1/8$ "

SOMFY AUTOMATION

Sonesse® 40 WireFree™ RTS Li-Ion - with 3-1/4" tube
Sonesse® 50 RTS - with 2-1/2" & 3-1/4" tube
Sonesse® ULTRA 50 AC - with 2-1/2" & 3-1/4" tube

Spring Ring

		Inside Mount	Outside Mount / Net Mount
Open Roll (No Top Treatment)	Shade Width	3/16 less than ordered width	Ordered Width
	Fabric & Tube Width (no end caps)	2-1/8" less than ordered width	1-15/16" less than ordered width
	Fabric & Tube Width (with end caps)	2-1/4" less than ordered width	2-1/16" less than ordered width
	<i>Control Side (in)</i>	1 1/16	15/16
	<i>Idler Side (in)</i>	1 1/16	1
4" Fascia (R-Series)	Fascia Width	3/16 less than ordered width	Ordered Width
	Fabric & Tube Width (no end caps)	2-1/8" less than ordered width	1-15/16" less than ordered width
	Fabric & Tube Width (with end caps)	2-3/16 less than ordered width	2" less than ordered width
	<i>Control Side (in)</i>	1	1
	<i>Idler Side (in)</i>	1 1/16	1

SOMFY AUTOMATION

Sonesse® 50 RTS
Sonesse® ULTRA 50 AC
2-1/2" & 3-1/4" tube

Drop In

		Inside Mount	Outside Mount / Net Mount
Open Roll (No Top Treatment)	Shade Width	3/16 less than ordered width	Ordered Width
	Fabric & Tube Width (no end caps)	2-11/16 less than ordered width	2-1/2" less than ordered width
	Fabric & Tube Width (with end caps)	2-13/16 less than ordered width	2-5/8" less than ordered width
	<i>Control Side (in)</i>	1 9/16	1 1/2
	<i>Idler Side (in)</i>	1 1/8	1
4" Fascia (R-Series)	Fascia Width	3/16 less than ordered width	Ordered Width
	Fabric & Tube Width (no end caps)	2-11/16 less than ordered width	2-1/2" less than ordered width
	Fabric & Tube Width (with end caps)	2-3/4 less than ordered width	2-9/16" less than ordered width
	<i>Control Side (in)</i>	1 9/16	1 1/2
	<i>Idler Side (in)</i>	1 1/8	1

Note:

- Fabric width + 1/4 to determine width of bottom rail with end caps. For shade with heat sealed hem bar, bottom rail width equates to fabric width
- Shade width for open roll and fabric cornice is measured from bracket end to bracket end (valance/cornice width measured separately).
- For shades with cassette, shade width is measured from cassette end cap to top treatment end cap.
- For shades with fascia ; shade width is measured from bracket end cap to end cap.

FINISHED DIMENSIONS

Adjustments are taken from ordered dimensions. Width and height may vary $\pm 1/8$ "

TOP TREATMENT ONLY

Fabric Cornice (Only)	Inside Mount	Outside Mount/Net Mount
Cornice Width Tip to Tip (no returns)	3/16 less than ordered width	N/A
Cornice Width Tip to Tip (with returns)	3/16 less than ordered width	Ordered Width

SOLAR OPTICAL INFORMATION

The following pages contain solar optical information by pattern and color, it is important to understand the numbers and how they work best to your need.

OPENNESS FACTOR (OF):

OF is a property that is often used to describe a screen material. The definition of OF is the percentage of the screen's surface area that is "open". The OF only describes one of the factors that regulates the amount of light passing through a roller shade.

The OF and color coating together will decide how open the (shade) material will become. Different material colors absorb light differently. For example, a dark colored car is hotter than a light colored car.

Sunlight that hits the shade surface is divided into three parts that together make 100 % of the incoming light. The picture below illustrates the phenomenon.

TRANSMISSION: One part of the light will pass through the shade, and that is the part of the light that comes into the room. *The lower the number, the better.*

The transmission value tells how much light passes through the fabric. The transmission is dependent on three factors;

- the openness factor of the fabric
- the color of the fabric
- the coating on the fabric.

REFLECTION: One part of the light will be reflected when it hits the shade. *The higher the number, the better.*

ABSORPTION: The rest of the light will be absorbed by the shade. *The lower the number, the better.*

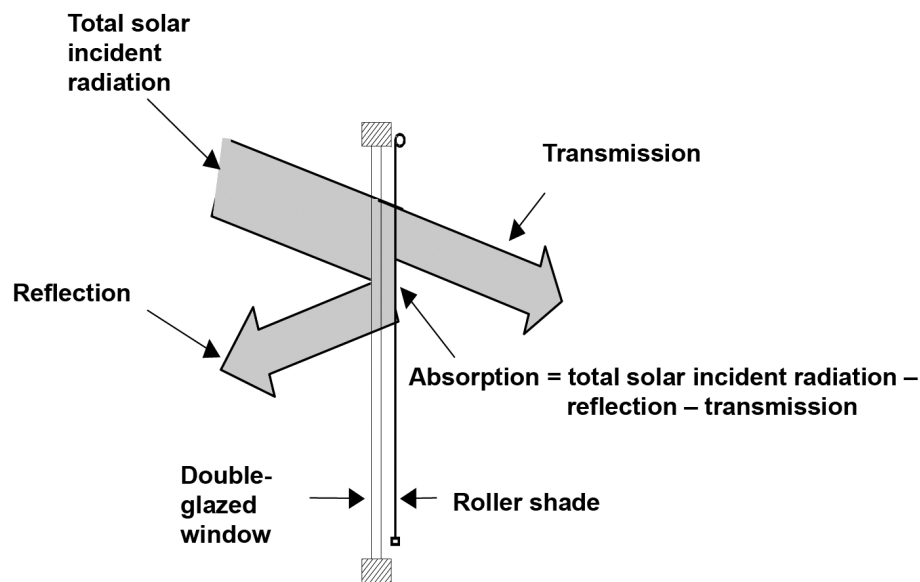

UV PROTECTION (and Blackout Fabrics): The total solar incident radiation of wavelengths between 280 nm and 2500 nm is measured and optical values are reported. UV-light is included in these wavelengths. For those of our fabrics that are Blackout the transmission of light is 0 %. This signifies 100 % blocking of all sunlight, including UV-light. The UV-protection is 100 % for the fabric. In order to get complete blocking of the light the fabric has to be fitted so that no light is transmitted on the sides of the fabric. *The higher the number, the better.*

SOLAR OPTICAL CHART

Collection Code	Collection Name	Color Code	Color Name	Openness Factor*	Transmission*	Reflection*	Absorption*	UV Rating*
R80	1% E Screen	09	Charcoal/Charcoal	1%	1	4	95	99%
R80	1% E Screen	07	Charcoal/Cocoa	1%	2	5	93	99%
R80	1% E Screen	08	Charcoal/Grey	1%	3	9	88	99%
R80	1% E Screen	05	White/Linen	1%	14	66	20	99%
R80	1% E Screen	03	White/Pearl	1%	9	58	33	99%
R80	1% E Screen	04	White/White	1%	14	75	11	99%
AS010	1% EnduroScreen	05	Black/Black	1%	NA	NA	NA	99%
AS010	1% EnduroScreen	04	Black/Bronze	1%	NA	NA	NA	99%
AS010	1% EnduroScreen	06	Black/Grey	1%	NA	NA	NA	99%
AS010	1% EnduroScreen	02	White/Beige	1%	NA	NA	NA	99%
AS010	1% EnduroScreen	03	White/Grey	1%	NA	NA	NA	99%
AS010	1% EnduroScreen	01	White/White	1%	NA	NA	NA	99%
AS013	1% Environs Screen	05	Black/Black	1%	NA	NA	NA	99%
AS013	1% Environs Screen	04	Black/Bronze	1%	NA	NA	NA	99%
AS013	1% Environs Screen	06	Black/Grey	1%	NA	NA	NA	99%
AS013	1% Environs Screen	02	White/Beige	1%	NA	NA	NA	99%
AS013	1% Environs Screen	03	White/Grey	1%	NA	NA	NA	99%
AS013	1% Environs Screen	01	White/White	1%	NA	NA	NA	99%
RS23	1% Nordic Screen Plus	04	Black/ Copper	1%	0	5	95	99%
RS23	1% Nordic Screen Plus	03	Black/Black	1%	0	3	96	99%
RS23	1% Nordic Screen Plus	01	Bright White	1%	26	66	8	99%
RS23	1% Nordic Screen Plus	06	White Gray	1%	5	58	37	99%
RS23	1% Nordic Screen Plus	05	White Linen	1%	12	73	15	99%
RS7	1% S Screen	03	Granite	1%	5	34	61	99%
RS7	1% S Screen	04	Papyrus	1%	7	39	54	99%
RS7	1% S Screen	02	Porcelain	1%	10	63	27	99%
R01	1% Sheerweave 2500	P84	Brite White	1%	15	72	13	99%
R01	1% Sheerweave 2500	03	Charcoal	1%	1	4	95	99%
R01	1% Sheerweave 2500	09	Charcoal/Alpaca	1%	1	16	83	99%
R01	1% Sheerweave 2500	06	Oyster/Beige	1%	10	60	30	99%
R01	1% Sheerweave 2500	07	Oyster/Pearl Gray	1%	7	50	43	99%
R01	1% Sheerweave 2500	Q20	Beige	1%	7	50	43	99%
R01	1% Sheerweave 2500	Q21	Beige/Pearl Gray	1%	5	42	53	99%
R01	1% Sheerweave 2500	04	Charcoal/Chestnut	1%	1	6	93	99%
R01	1% Sheerweave 2500	V22	Charcoal/Gray	1%	2	8	90	99%
R01	1% Sheerweave 2500	05	Oyster	1%	15	68	17	99%
R01	1% Sheerweave 2500	V20	Pearl Gray	1%	3	32	65	99%
RS21	1% Sheerweave 2701	01	Oyster	1%	19	69	12	99%
RS21	1% Sheerweave 2701	02	Oyster/Beige	1%	15	55	30	99%
RS21	1% Sheerweave 2701	06	Oyster/Charcoal	1%	15	11	83	99%
RS21	1% Sheerweave 2701	03	Oyster/Pearl Gray	1%	11	38	51	99%
RS21	1% Sheerweave 2701	04	Oyster/Pewter	1%	6	22	72	N/A
RS21	1% Sheerweave 2701	V21	Charcoal	1%	3	4	93	99%
RS21	1% Sheerweave 2701	V66	Charcoal/Brown	1%	4	17	78	99%
RS21	1% Sheerweave 2701	V22	Charcoal/Gray	1%	3	14	83	99%
RS21	1% Sheerweave 2701	V64	Charcoal/Slate	1%	4	30	66	99%
RS21	1% Sheerweave 2701	V65	Charcoal/Taupe	1%	4	25	71	99%
RS21	1% Sheerweave 2701	05	Oyster/Chestnut	1%	6	16	77	99%
P4001	1% Sheerweave 4001	U59	Alabaster	1%	4	65	31	99%
P4001	1% Sheerweave 4001	U64	Ash	1%	2	14	84	99%
P4001	1% Sheerweave 4001	U58	Chalk	1%	7	83	10	99%
P4001	1% Sheerweave 4001	U65	Ebony	1%	1	4	95	99%
P4001	1% Sheerweave 4001	U62	Granite	1%	3	51	46	99%
P4001	1% Sheerweave 4001	U61	Graystone	1%	2	38	60	99%
P4001	1% Sheerweave 4001	U60	Pebblestone	1%	2	51	47	99%
P4001	1% Sheerweave 4001	U63	Pewter	1%	3	51	46	99%
P4001	1% Sheerweave 4001	U66	Tobacco	1%	1	4	95	99%

*See SOLAR OPTICAL INFORMATION section for detail.

SOLAR OPTICAL CHART

Collection Code	Collection Name	Color Code	Color Name	Openness Factor*	Transmission*	Reflection*	Absorption*	UV Rating*
P4901	1% Sheerweave 4901	Q25	Birch	1%	5	57	38	N/A
P4901	1% Sheerweave 4901	P06	Chalk	1%	9	83	8	N/A
P4901	1% Sheerweave 4901	P25	Chalk/Black	1%	1	22	77	N/A
P4901	1% Sheerweave 4901	P26	Chalk/Wheat	1%	6	65	29	N/A
P4901	1% Sheerweave 4901	Q26	Cobblestone	1%	3	36	61	N/A
P4901	1% Sheerweave 4901	V10	Ebony	1%	1	5	94	N/A
P4901	1% Sheerweave 4901	Q22	Flaxen	1%	3	42	55	N/A
P4901	1% Sheerweave 4901	Q07	Kettal Grey	1%	3	48	49	N/A
P4901	1% Sheerweave 4901	V03	Pewter/Chalk	1%	3	56	41	N/A
P4901	1% Sheerweave 4901	V28	Slate	1%	2	11	87	N/A
P4901	1% Sheerweave 4901	Q27	Soft Grey	1%	5	58	37	N/A
P4901	1% Sheerweave 4901	Q16	Tobacco	1%	3	42	55	N/A
P4901	1% Sheerweave 4901	Q23	Whitesands	1%	7	65	28	N/A
P5001	1% Sheerweave 5000	V17	Jute/Fog	1%	9	58	34	N/A
P5001	1% Sheerweave 5000	R85	June/Parchment	1%	13	70	17	99%
P5001	1% Sheerweave 5000	R88	Jute/Coffee	1%	5	15	80	N/A
P5001	1% Sheerweave 5000	R86	Jute/Flax	1%	30	56	14	N/A
P5001	1% Sheerweave 5000	R87	Jute/Latte	1%	24	50	26	N/A
P5001	1% Sheerweave 5000	V18	Jute/Smoke	1%	17	49	34	N/A
R19	10% E Screen	02	Charcoal/Charcoal	10%	12	3	85	10%
R19	10% E Screen	08	White Pearl	10%	20	50	30	10%
R19	10% E Screen	06	White/White	10%	25	66	9	10%
P2360	10% Sheerweave 2360	Q20	Beige	10%	19	44	37	10%
P2360	10% Sheerweave 2360	Q21	Beige/Pearl Gray	10%	17	39	44	10%
P2360	10% Sheerweave 2360	P84	Brite White	10%	27	62	11	10%
P2360	10% Sheerweave 2360	V21	Charcoal	10%	10	4	86	10%
P2360	10% Sheerweave 2360	V32	Charcoal/Alpaca	10%	12	15	73	10%
P2360	10% Sheerweave 2360	V24	Charcoal/Chestnut	10%	11	5	84	10%
P2360	10% Sheerweave 2360	V22	Charcoal/Gray	10%	12	8	80	10%
P2360	10% Sheerweave 2360	P12	Oyster	10%	27	57	16	10%
P2360	10% Sheerweave 2360	P13	Oyster/Beige	10%	24	51	25	10%
P2360	10% Sheerweave 2360	P14	Oyster/Pearl Gray	10%	20	45	35	10%
P2360	10% Sheerweave 2360	V20	Pearl Gray	10%	16	30	54	10%
P4100	10% Sheerweave 4100	U59	Eco/Alabaster	10%	19	56	25	99%
P4100	10% Sheerweave 4100	U64	Eco/Ash	10%	11	12	77	99%
P4100	10% Sheerweave 4100	U58	Eco/Chalk	10%	17	74	9	99%
P4100	10% Sheerweave 4100	U65	Eco/Ebony	10%	10	4	86	99%
P4100	10% Sheerweave 4100	U62	Eco/Granite	10%	14	52	34	99%
P4100	10% Sheerweave 4100	U61	Eco/Greystone	10%	12	36	52	99%
P4100	10% Sheerweave 4100	U60	Eco/Pebblestone	10%	12	46	42	99%
P4100	10% Sheerweave 4100	U63	Eco/Pewter	10%	11	29	60	99%
P4100	10% Sheerweave 4100	U66	Eco/Tobacco	10%	12	5	83	99%
R26	10% Sheerweave 5000	03	Bamboo/Birch	10%	21	59	20	10%
R26	10% Sheerweave 5000	U28	Seaglass/Chardonnay	10%	40	43	17	10%
R26	10% Sheerweave 5000	U29	Seaglass/Crystal	10%	44	49	7	10%
R26	10% Sheerweave 5000	U24	Seaglass/Silver	10%	33	27	40	10%
AS028	3% Bamboo	02	Sand	3%	NA	NA	NA	97%
AS028	3% Bamboo	03	Sea Grass	3%	NA	NA	NA	97%
AS024	3% Bellflower	03	Deep Ocean	3%	NA	NA	NA	97%
AS024	3% Bellflower	02	Light Taupe	3%	NA	NA	NA	97%
AS024	3% Bellflower	04	Waterstone	3%	NA	NA	NA	97%
AS026	3% Delhi	02	Royal Navy	3%	NA	NA	NA	97%
AS026	3% Delhi	01	Westport Gray	3%	NA	NA	NA	97%
R81	3% E Screen	02	Charcoal/Charcoal	3%	5	4	91	3%
R81	3% E Screen	07	Charcoal/Cocoa	3%	4	7	89	3%
R81	3% E Screen	08	Charcoal/Grey	3%	5	10	85	3%
R81	3% E Screen	04	White/Linen	3%	16	63	21	3%
R81	3% E Screen	05	White/Pearl	3%	10	52	38	3%
R81	3% E Screen	06	White/White	3%	16	73	11	3%

*See SOLAR OPTICAL INFORMATION section for detail.

SOLAR OPTICAL CHART

Collection Code	Collection Name	Color Code	Color Name	Openness Factor*	Transmission*	Reflection*	Absorption*	UV Rating*
AS008	3% Ecoscape Screen	04	Black	3%	NA	NA	NA	97%
AS008	3% Ecoscape Screen	05	Black/Grey	3%	NA	NA	NA	97%
AS008	3% Ecoscape Screen	03	Grey	3%	NA	NA	NA	97%
AS008	3% Ecoscape Screen	02	Linen	3%	NA	NA	NA	97%
AS008	3% Ecoscape Screen	01	White	3%	NA	NA	NA	97%
AS011	3% EnduroScreen	05	Black/Black	3%	NA	NA	NA	97%
AS011	3% EnduroScreen	04	Black/Bronze	3%	NA	NA	NA	97%
AS011	3% EnduroScreen	06	Black/Grey	3%	NA	NA	NA	97%
AS011	3% EnduroScreen	02	White/Beige	3%	NA	NA	NA	97%
AS011	3% EnduroScreen	03	White/Grey	3%	NA	NA	NA	97%
AS011	3% EnduroScreen	01	White/White	3%	NA	NA	NA	97%
AS014	3% Environs Screen	05	Black/Black	3%	NA	NA	NA	97%
AS014	3% Environs Screen	04	Black/Bronze	3%	NA	NA	NA	97%
AS014	3% Environs Screen	06	Black/Grey	3%	NA	NA	NA	97%
AS014	3% Environs Screen	02	White/Beige	3%	NA	NA	NA	97%
AS014	3% Environs Screen	03	White/Grey	3%	NA	NA	NA	97%
AS014	3% Environs Screen	01	White/White	3%	NA	NA	NA	97%
AS027	3% Lady Amherst	02	Amore Pink	3%	NA	NA	NA	97%
AS027	3% Lady Amherst	05	Fair Haven	3%	NA	NA	NA	97%
AS027	3% Lady Amherst	06	Seabrook	3%	NA	NA	NA	97%
AS027	3% Lady Amherst	03	Silver	3%	NA	NA	NA	97%
AS027	3% Lady Amherst	04	Soft Sky	3%	NA	NA	NA	97%
RS24	3% Nordic Screen Plus	04	Black/ Copper	3%	3	6	91	97%
RS24	3% Nordic Screen Plus	03	Black/Black	3%	3	3	93	3%
RS24	3% Nordic Screen Plus	01	Bright White	3%	30	63	8	3%
RS24	3% Nordic Screen Plus	06	White Gray	3%	8	51	40	N/A
RS24	3% Nordic Screen Plus	05	White Linen	3%	15	70	15	N/A
R06	3% Sheerweave 2410	P84	Brite White	3%	18	70	12	3%
R06	3% Sheerweave 2410	03	Charcoal	3%	3	3	94	3%
R06	3% Sheerweave 2410	09	Charcoal/Alpaca	3%	4	20	76	3%
R06	3% Sheerweave 2410	06	Oyster/Beige	3%	11	55	34	3%
R06	3% Sheerweave 2410	07	Oyster/Pearl Gray	3%	9	44	47	3%
R06	3% Sheerweave 2410	Q20	Beige	3%	10	48	42	3%
R06	3% Sheerweave 2410	Q21	Beige/Pearl Gray	3%	7	39	54	3%
R06	3% Sheerweave 2410	04	Charcoal/Chestnut	3%	3	6	91	3%
R06	3% Sheerweave 2410	V22	Charcoal/Gray	3%	3	9	88	3%
R06	3% Sheerweave 2410	05	Oyster	3%	17	64	19	3%
R06	3% Sheerweave 2410	V20	Pearl Gray	3%	6	31	63	3%
P2703	3% Sheerweave 2703	P12	Oyster	3%	22	66	12	3%
P2703	3% Sheerweave 2703	P13	Oyster/Beige	3%	21	53	26	3%
P2703	3% Sheerweave 2703	P28	Oyster/Charcoal	3%	9	12	79	3%
P2703	3% Sheerweave 2703	P14	Oyster/Pearl Gray	3%	15	38	47	3%
P2703	3% Sheerweave 2703	P91	Oyster/Pewter	3%	10	22	68	3%
P2703	3% Sheerweave 2703	V21	Charcoal	3%	3	4	93	3%
P2703	3% Sheerweave 2703	V66	Charcoal/Brown	3%	6	17	77	3%
P2703	3% Sheerweave 2703	V22	Charcoal/Gray	3%	5	13	82	3%
P2703	3% Sheerweave 2703	V64	Charcoal/Slate	3%	7	27	66	3%
P2703	3% Sheerweave 2703	V65	Charcoal/Taupe	3%	6	24	70	3%
P2703	3% Sheerweave 2703	P92	Oyster/Chestnut	3%	12	19	69	3%
RS2	3% Sheerweave 4400	200	Eco/Alabaster	3%	10	65	28	97%
RS2	3% Sheerweave 4400	U64	Eco/Ash	3%	3	12	85	97%
RS2	3% Sheerweave 4400	202	Eco/Chalk	3%	10	79	11	97%
RS2	3% Sheerweave 4400	U65	Eco/Ebony	3%	3	4	93	97%
RS2	3% Sheerweave 4400	U62	Eco/Granite	3%	6	55	39	97%
RS2	3% Sheerweave 4400	201	Eco/Greystone	3%	4	40	56	97%
RS2	3% Sheerweave 4400	U60	Eco/Pebblestone	3%	4	49	47	97%
RS2	3% Sheerweave 4400	203	Eco/Pewter	3%	4	32	64	97%
RS2	3% Sheerweave 4400	U66	Eco/Tobacco	3%	3	5	92	97%
P4600	3% Sheerweave 4600	V95	Cappuccino	3%	4	20	76	97%
P4600	3% Sheerweave 4600	P06	Chalk	3%	10	74	16	3%
P4600	3% Sheerweave 4600	V96	Dark Bronze	3%	4	5	91	3%
P4600	3% Sheerweave 4600	V10	Ebony	3%	5	43	52	3%
P4600	3% Sheerweave 4600	Q59	Ecru	3%	7	58	35	3%
P4600	3% Sheerweave 4600	Q60	Golden Sand	3%	6	37	57	3%
P4600	3% Sheerweave 4600	P10	Granite	3%	5	43	52	3%
P4600	3% Sheerweave 4600	U32	Linen	3%	8	64	28	3%
P4600	3% Sheerweave 4600	V07	Pewter	3%	5	31	64	3%
P4600	3% Sheerweave 4600	V44	Sandstone	3%	5	39	56	3%

*See SOLAR OPTICAL INFORMATION section for detail.

SOLAR OPTICAL CHART

Collection Code	Collection Name	Color Code	Color Name	Openness Factor*	Transmission*	Reflection*	Absorption*	UV Rating*
P4903	3% Sheerweave 4903	Q25	Birch	3%	7	56	37	3%
P4903	3% Sheerweave 4903	P06	Chalk	3%	11	81	8	3%
P4903	3% Sheerweave 4903	P25	Chalk/Black	3%	3	25	72	3%
P4903	3% Sheerweave 4903	P26	Chalk/Wheat	3%	9	65	26	3%
P4903	3% Sheerweave 4903	Q26	Cobblestone	3%	4	38	58	3%
P4903	3% Sheerweave 4903	V10	Ebony	3%	3	5	92	3%
P4903	3% Sheerweave 4903	Q22	Flaxen	3%	6	43	51	3%
P4903	3% Sheerweave 4903	Q07	Kettal Grey	3%	4	47	49	3%
P4903	3% Sheerweave 4903	V03	Pewter/Chalk	3%	4	53	43	3%
P4903	3% Sheerweave 4903	V28	Slate	3%	3	12	85	3%
P4903	3% Sheerweave 4903	Q27	Soft Grey	3%	8	57	35	3%
P4903	3% Sheerweave 4903	Q16	Tobacco	3%	3	8	89	3%
P4903	3% Sheerweave 4903	Q23	Whitesands	3%	9	63	28	3%
R07	3% Sheerweave 5000	04	Linen/Cream	3%	22	46	31	3%
R07	3% Sheerweave 5000	10	Bark/Sienna	3%	6	16	78	3%
R07	3% Sheerweave 5000	07	Chenille/Honey	3%	26	47	27	3%
R07	3% Sheerweave 5000	R89	Chenille/Marshmallow	3%	16	67	17	97%
R07	3% Sheerweave 5000	02	Linen/Cinnamon	3%	6	20	74	3%
R07	3% Sheerweave 5000	05	Linen/Fig	3%	6	15	79	3%
AS029	3% Sovereign	02	Evening	3%	NA	NA	NA	97%
AS029	3% Sovereign	01	Sepia	3%	NA	NA	NA	97%
AS029	3% Sovereign	03	Stonewall	3%	NA	NA	NA	97%
AS006	3% Tweed Screen	04	Almond	3%	NA	NA	NA	97%
AS006	3% Tweed Screen	01	Bronze	3%	NA	NA	NA	97%
AS006	3% Tweed Screen	03	Buttercream	3%	NA	NA	NA	97%
AS006	3% Tweed Screen	02	Gray	3%	NA	NA	NA	97%
RS15	4% S Screen	004	Granite	4%	9	31	60	4%
RS15	4% S Screen	003	Papyrus	4%	11	38	51	4%
RS15	4% S Screen	001	Porcelain	4%	12	59	29	4%
R51	5% E Screen	05	Charcoal/Charcoal	5%	7	10	83	95%
R51	5% E Screen	04	Charcoal/Cocoa	5%	7	6	87	95%
R51	5% E Screen	10	Charcoal/Grey	5%	7	10	83	95%
R51	5% E Screen	08	White/Linen	5%	20	62	18	95%
R51	5% E Screen	09	White/Pearl	5%	12	51	37	95%
R51	5% E Screen	01	White/White	5%	20	71	9	95%
AS009	5% Ecoscape Screen	04	Black	5%	NA	NA	NA	95%
AS009	5% Ecoscape Screen	05	Black/Grey	5%	NA	NA	NA	95%
AS009	5% Ecoscape Screen	03	Grey	5%	NA	NA	NA	95%
AS009	5% Ecoscape Screen	02	Linen	5%	NA	NA	NA	95%
AS009	5% Ecoscape Screen	01	White	5%	NA	NA	NA	95%
AS012	5% EnduroScreen	05	Black/Black	5%	NA	NA	NA	95%
AS012	5% EnduroScreen	04	Black/Bronze	5%	NA	NA	NA	95%
AS012	5% EnduroScreen	06	Black/Grey	5%	NA	NA	NA	95%
AS012	5% EnduroScreen	02	White/Beige	5%	NA	NA	NA	95%
AS012	5% EnduroScreen	03	White/Grey	5%	NA	NA	NA	95%
AS012	5% EnduroScreen	01	White/White	5%	NA	NA	NA	95%
AS015	5% Environs Screen	05	Black/Black	5%	NA	NA	NA	95%
AS015	5% Environs Screen	04	Black/Bronze	5%	NA	NA	NA	95%
AS015	5% Environs Screen	06	Black/Grey	5%	NA	NA	NA	95%
AS015	5% Environs Screen	02	White/Beige	5%	NA	NA	NA	95%
AS015	5% Environs Screen	03	White/Grey	5%	NA	NA	NA	95%
AS015	5% Environs Screen	01	White/White	5%	NA	NA	NA	95%
R61	5% M Screen Deco	06	Parchment	5%	16	63	21	95%
R61	5% M Screen Deco	02	River Rock	5%	10	33	57	95%
R61	5% M Screen Deco	03	Tumbleweed	5%	10	29	61	95%
RS25	5% Nordic Screen Plus	04	Black/ Copper	5%	7	6	87	95%
RS25	5% Nordic Screen Plus	03	Black/Black	5%	6	3	91	95%
RS25	5% Nordic Screen Plus	01	Bright White	5%	32	61	8	95%
RS25	5% Nordic Screen Plus	06	White Gray	5%	32	61	8	95%
RS25	5% Nordic Screen Plus	05	White Linen	5%	18	6	15	95%

*See SOLAR OPTICAL INFORMATION section for detail.

SOLAR OPTICAL CHART

Collection Code	Collection Name	Color Code	Color Name	Openness Factor*	Transmission*	Reflection*	Absorption*	UV Rating*
P2000	5% Sheerweave 2000	Q05	Bone	5%	18	55	27	95%
P2000	5% Sheerweave 2000	Q06	Bone/Platinum	5%	12	43	45	95%
P2000	5% Sheerweave 2000	Q10	Bronze	5%	5	7	88	95%
P2000	5% Sheerweave 2000	V21	Charcoal	5%	6	4	90	95%
P2000	5% Sheerweave 2000	V24	Charcoal/Chestnut	5%	6	7	87	95%
P2000	5% Sheerweave 2000	V22	Charcoal/Gray	5%	7	9	84	95%
P2000	5% Sheerweave 2000	V04	Platinum	5%	10	35	55	95%
P2000	5% Sheerweave 2000	P02	White	5%	20	67	13	95%
P2000	5% Sheerweave 2000	P04	White/Bone	5%	18	61	21	95%
P2000	5% Sheerweave 2000	P05	White/Platinum	5%	13	49	38	95%
RS1	5% Sheerweave 2390	P84	Brite White	5%	22	67	11	95%
RS1	5% Sheerweave 2390	105	Charcoal	5%	4	4	92	95%
RS1	5% Sheerweave 2390	101	Oyster/Beige	5%	17	54	29	N/A
RS1	5% Sheerweave 2390	103	Oyster/Pearl Gray	5%	14	45	41	N/A
RS1	5% Sheerweave 2390	Q20	Beige	5%	14	47	39	95%
RS1	5% Sheerweave 2390	Q21	Beige/Pearl Gray	5%	11	38	51	95%
RS1	5% Sheerweave 2390	106	Charcoal/Alpaca	5%	7	18	75	N/A
RS1	5% Sheerweave 2390	104	Charcoal/Chestnut	5%	6	6	88	N/A
RS1	5% Sheerweave 2390	102	Charcoal/Gray	5%	5	9	86	N/A
RS1	5% Sheerweave 2390	100	Oyster	5%	21	61	18	N/A
RS1	5% Sheerweave 2390	V20	Pearl Gray	5%	10	31	59	N/A
P2705	5% Sheerweave 2705	V21	Charcoal	5%	7	4	89	N/A
P2705	5% Sheerweave 2705	V66	Charcoal/Brown	5%	9	16	75	N/A
P2705	5% Sheerweave 2705	V22	Charcoal/Gray	5%	8	6	86	N/A
P2705	5% Sheerweave 2705	V64	Charcoal/Slate	5%	9	25	66	N/A
P2705	5% Sheerweave 2705	V65	Charcoal/Taupe	5%	9	21	70	N/A
P2705	5% Sheerweave 2705	P12	Oyster	5%	25	63	12	N/A
P2705	5% Sheerweave 2705	P13	Oyster/Beige	5%	22	54	24	N/A
P2705	5% Sheerweave 2705	P28	Oyster/Charcoal	5%	12	14	74	N/A
P2705	5% Sheerweave 2705	P92	Oyster/Chestnut	5%	11	19	70	N/A
P2705	5% Sheerweave 2705	P14	Oyster/Pearl Gray	5%	19	51	30	N/A
P2705	5% Sheerweave 2705	P91	Oyster/Pewter	5%	15	24	61	N/A
R09	5% Sheerweave 4000	01	Eco/Alabaster	5%	6	66	28	95%
R09	5% Sheerweave 4000	U64	Eco/Ash	5%	6	13	81	95%
R09	5% Sheerweave 4000	02	Eco/Chalk	5%	14	77	9	95%
R09	5% Sheerweave 4000	U65	Eco/Ebony	5%	7	4	89	95%
R09	5% Sheerweave 4000	06	Eco/Granite	5%	9	51	40	95%
R09	5% Sheerweave 4000	04	Eco/Greystone	5%	8	38	54	95%
R09	5% Sheerweave 4000	U60	Eco/Pebblestone	5%	8	48	44	95%
R09	5% Sheerweave 4000	U63	Eco/Pewter	5%	8	31	61	95%
R09	5% Sheerweave 4000	U66	Eco/Tobacco	5%	6	6	88	95%
P4500	5% Sheerweave 4500	V95	Cappuccino	5%	6	18	76	N/A
P4500	5% Sheerweave 4500	P06	Chalk	5%	12	74	14	N/A
P4500	5% Sheerweave 4500	V96	Dark Bronze	5%	7	5	88	N/A
P4500	5% Sheerweave 4500	V10	Ebony	5%	5	3	92	N/A
P4500	5% Sheerweave 4500	Q59	Ecru	5%	9	56	35	N/A
P4500	5% Sheerweave 4500	Q60	Golden Sand	5%	7	37	56	N/A
P4500	5% Sheerweave 4500	P10	Granite	5%	6	47	47	N/A
P4500	5% Sheerweave 4500	U32	Linen	5%	11	63	26	N/A
P4500	5% Sheerweave 4500	V07	Pewter	5%	6	30	64	N/A
P4500	5% Sheerweave 4500	V44	Sandstone	5%	8	40	52	N/A
R10	5% Sheerweave 5000	14	Linen/Pearl	5%	36	50	14	N/A
R10	5% Sheerweave 5000	15	Linen/Taupe	5%	22	39	39	N/A
R10	5% Sheerweave 5000	09	Bark/Ash	5%	8	29	63	N/A
R10	5% Sheerweave 5000	10	Bark/Pewter	5%	11	35	54	N/A
R10	5% Sheerweave 5000	01	Bark/Tiger Oak	5%	17	24	59	N/A
R10	5% Sheerweave 5000	07	Chenille/Driftwood	5%	12	26	52	N/A
R10	5% Sheerweave 5000	Q43	Marble/Sand	5%	9	48	43	N/A
R10	5% Sheerweave 5000	19	Metro /Platinum	5%	29	31	40	N/A
R10	5% Sheerweave 5000	06	Tweed Oatmeal	5%	11	34	55	95%
R10	5% Sheerweave 5000	03	Tweed/Buckeye	5%	9	28	63	N/A
AS007	5% Spectra Screen	02	Amazon	5%	NA	NA	NA	95%
AS007	5% Spectra Screen	01	Apple Green	5%	NA	NA	NA	95%
AS007	5% Spectra Screen	10	Caramel	5%	NA	NA	NA	95%
AS007	5% Spectra Screen	03	Cookie	5%	NA	NA	NA	95%
AS007	5% Spectra Screen	05	Coral	5%	NA	NA	NA	95%
AS007	5% Spectra Screen	09	Maroon	5%	NA	NA	NA	95%
AS007	5% Spectra Screen	07	Mocha	5%	NA	NA	NA	95%
AS007	5% Spectra Screen	06	Olive	5%	NA	NA	NA	95%
AS007	5% Spectra Screen	04	Pistachio	5%	NA	NA	NA	95%
AS007	5% Spectra Screen	08	Tan	5%	NA	NA	NA	95%

*See SOLAR OPTICAL INFORMATION section for detail.

SOLAR OPTICAL CHART

Collection Code	Collection Name	Color Code	Color Name	Openness Factor*	Transmission*	Reflection*	Absorption*	UV Rating*
AS005	5% Willow Screen	04	Barley	5%	NA	NA	NA	95%
AS005	5% Willow Screen	02	Cappuccino	5%	NA	NA	NA	95%
AS005	5% Willow Screen	01	Dark Chocolate	5%	NA	NA	NA	95%
AS005	5% Willow Screen	07	Deep Brown	5%	NA	NA	NA	95%
AS005	5% Willow Screen	03	Nobel Brown	5%	NA	NA	NA	95%
AS005	5% Willow Screen	05	Oyster	5%	NA	NA	NA	95%
AS005	5% Willow Screen	06	Parchment	5%	NA	NA	NA	95%
R34	7% Sheerweave 5000	Q46	Bamboo/Wheat	7%	19	29	52	N/A
R34	7% Sheerweave 5000	08	Linen/Clay	7%	23	32	45	N/A
AF034	Adelaide	02	Cream	Light Filtering	NA	NA	NA	NA
AF034	Adelaide	04	Mink	Light Filtering	NA	NA	NA	NA
AF034	Adelaide	01	Parchment	Light Filtering	NA	NA	NA	NA
AF034	Adelaide	03	Silver	Light Filtering	NA	NA	NA	NA
AB034	Adelaide Blackout	02	Cream	Light Filtering	NA	NA	NA	NA
AB034	Adelaide Blackout	04	Mink	Light Filtering	NA	NA	NA	NA
AB034	Adelaide Blackout	01	Parchment	Light Filtering	NA	NA	NA	NA
AB034	Adelaide Blackout	03	Silver	Light Filtering	NA	NA	NA	NA
AF016	Aegean	01	Camel	Light Filtering	NA	NA	NA	NA
AF016	Aegean	04	Galaxy	Light Filtering	NA	NA	NA	NA
AF016	Aegean	02	Light Gray	Light Filtering	NA	NA	NA	NA
AF016	Aegean	03	Pacific	Light Filtering	NA	NA	NA	NA
AF030	Alpine	03	Caraway	Light Filtering	NA	NA	NA	NA
AF030	Alpine	02	Driftwood	Light Filtering	NA	NA	NA	NA
AF030	Alpine	04	Peppercorn	Light Filtering	NA	NA	NA	NA
AF030	Alpine	01	Sesame	Light Filtering	NA	NA	NA	NA
AB030	Alpine Blackout	03	Caraway	Light Filtering	NA	NA	NA	NA
AB030	Alpine Blackout	02	Driftwood	Light Filtering	NA	NA	NA	NA
AB030	Alpine Blackout	04	Peppercorn	Light Filtering	NA	NA	NA	NA
AB030	Alpine Blackout	01	Sesame	Light Filtering	NA	NA	NA	NA
AF020	Aqua-Tex	06	Black	Light Filtering	NA	NA	NA	NA
AF020	Aqua-Tex	05	Kiwi	Light Filtering	NA	NA	NA	NA
AF020	Aqua-Tex	03	Linen	Light Filtering	NA	NA	NA	NA
AF020	Aqua-Tex	04	Periwinkle	Light Filtering	NA	NA	NA	NA
AF020	Aqua-Tex	02	Silver	Light Filtering	NA	NA	NA	NA
AF020	Aqua-Tex	01	Snowflake	Light Filtering	NA	NA	NA	NA
AB020	Aqua-Tex Blackout	06	Black	Light Filtering	NA	NA	NA	NA
AB020	Aqua-Tex Blackout	03	Linen	Light Filtering	NA	NA	NA	NA
AB020	Aqua-Tex Blackout	02	Silver	Light Filtering	NA	NA	NA	NA
AB020	Aqua-Tex Blackout	01	Snowflake	Light Filtering	NA	NA	NA	NA
AF035	Arches	01	Pearl	Light Filtering	NA	NA	NA	NA
AF035	Arches	02	Sesame	Light Filtering	NA	NA	NA	NA
AF035	Arches	04	Shadow	Light Filtering	NA	NA	NA	NA
AF035	Arches	03	Taupe	Light Filtering	NA	NA	NA	NA
AB035	Arches Blackout	01	Pearl	Blackout	NA	NA	NA	NA
AB035	Arches Blackout	02	Sesame	Blackout	NA	NA	NA	NA
AB035	Arches Blackout	04	Shadow	Blackout	NA	NA	NA	NA
AB035	Arches Blackout	03	Taupe	Blackout	NA	NA	NA	NA
AB022	Aries Blackout	03	Daybreak	Light Filtering	NA	NA	NA	NA
AB022	Aries Blackout	01	Linen	Light Filtering	NA	NA	NA	NA
AB022	Aries Blackout	02	Silver	Light Filtering	NA	NA	NA	NA
AF019	Baltic	03	Cadet Blue	Light Filtering	NA	NA	NA	NA
AF019	Baltic	02	Carbon	Light Filtering	NA	NA	NA	NA
AF019	Baltic	04	Citron	Light Filtering	NA	NA	NA	NA
AF019	Baltic	01	Pale Taupe	Light Filtering	NA	NA	NA	NA
AB019	Baltic Blackout	03	Cadet Blue	Light Filtering	NA	NA	NA	NA
AB019	Baltic Blackout	02	Carbon	Light Filtering	NA	NA	NA	NA
AB019	Baltic Blackout	04	Citron	Light Filtering	NA	NA	NA	NA
AB019	Baltic Blackout	01	Pale Taupe	Light Filtering	NA	NA	NA	NA
AF028	Bamboo	01	Chalk	Light Filtering	NA	NA	NA	NA
AF028	Bamboo	02	Sand	Light Filtering	NA	NA	NA	NA
AF028	Bamboo	03	Sea Grass	Light Filtering	NA	NA	NA	NA
AB028	Bamboo Blackout	03	Sea Grass	Blackout	NA	NA	NA	NA
AB028	Bamboo Blackout	02	Sand	Blackout	NA	NA	NA	NA

*See SOLAR OPTICAL INFORMATION section for detail.

SOLAR OPTICAL CHART

Collection Code	Collection Name	Color Code	Color Name	Openness Factor*	Transmission*	Reflection*	Absorption*	UV Rating*
AF024	Bellflower	03	Deep Ocean	Light Filtering	NA	NA	NA	NA
AF024	Bellflower	01	Frost	Light Filtering	NA	NA	NA	NA
AF024	Bellflower	02	Light Taupe	Light Filtering	NA	NA	NA	NA
AF024	Bellflower	04	Waterstone	Light Filtering	NA	NA	NA	NA
AB024	Bellflower Blackout	03	Deep Ocean	Blackout	NA	NA	NA	NA
AB024	Bellflower Blackout	02	Light Taupe	Blackout	NA	NA	NA	NA
AB024	Bellflower Blackout	04	Waterstone	Blackout	NA	NA	NA	NA
R40	Blackout - Solid	11	Alabaster	Light Filtering	NA	NA	NA	NA
R40	Blackout - Solid	05	Bone	Light Filtering	NA	NA	NA	NA
R40	Blackout - Solid	01	White	Light Filtering	NA	NA	NA	NA
AF031	Bonn	04	French Blue	Light Filtering	NA	NA	NA	NA
AF031	Bonn	03	Heather	Light Filtering	NA	NA	NA	NA
AF031	Bonn	05	Rosewood	Light Filtering	NA	NA	NA	NA
AF031	Bonn	01	Soft Linen	Light Filtering	NA	NA	NA	NA
AF031	Bonn	02	Tan	Light Filtering	NA	NA	NA	NA
RD8	Brilliance	11	Charcoal	Light Filtering	NA	NA	NA	NA
RD8	Brilliance	07	Chiffon	Light Filtering	NA	NA	NA	NA
RD8	Brilliance	10	Copper	Light Filtering	NA	NA	NA	NA
RD8	Brilliance	09	Dolphin	Light Filtering	NA	NA	NA	NA
RD8	Brilliance	08	Limestone	Light Filtering	NA	NA	NA	NA
RB6	Brilliance Blackout	11	Charcoal	Light Filtering	NA	NA	NA	NA
RB6	Brilliance Blackout	07	Chiffon	Light Filtering	NA	NA	NA	NA
RB6	Brilliance Blackout	10	Copper	Light Filtering	NA	NA	NA	NA
RB6	Brilliance Blackout	09	Dolphin	Light Filtering	NA	NA	NA	NA
RB6	Brilliance Blackout	08	Limestone	Light Filtering	NA	NA	NA	NA
AF040	Burton	03	Cloud	Light Filtering	NA	NA	NA	NA
AF040	Burton	02	Ivory	Light Filtering	NA	NA	NA	NA
AF040	Burton	01	Opal	Light Filtering	NA	NA	NA	NA
RD6	Carrara	06	Coal	Light Filtering	NA	NA	NA	NA
RD6	Carrara	08	Dove Gray	Light Filtering	NA	NA	NA	NA
RD6	Carrara	07	Shea	Light Filtering	NA	NA	NA	NA
RD6	Carrara	03	Silver	Light Filtering	NA	NA	NA	NA
RD6	Carrara	05	Storm	Light Filtering	NA	NA	NA	NA
RD6	Carrara	02	Tusk	Light Filtering	NA	NA	NA	NA
RD6	Carrara	01	White	Light Filtering	NA	NA	NA	NA
RB4	Carrara Blackout	06	Coal	Blackout	NA	NA	NA	NA
RB4	Carrara Blackout	08	Dove Gray	Blackout	NA	NA	NA	NA
RB4	Carrara Blackout	07	Shea	Blackout	NA	NA	NA	NA
RB4	Carrara Blackout	03	Silver	Blackout	NA	NA	NA	NA
RB4	Carrara Blackout	05	Storm	Blackout	NA	NA	NA	NA
RB4	Carrara Blackout	02	Tusk	Blackout	NA	NA	NA	NA
RB4	Carrara Blackout	01	White	Blackout	NA	NA	NA	NA
RB16	Chesapeake Blackout	03	Coastal	Light Filtering	NA	NA	NA	NA
RB16	Chesapeake Blackout	01	Seashell	Light Filtering	NA	NA	NA	NA
RD7	Claudio	10	Cotton	Light Filtering	NA	NA	NA	NA
RD7	Claudio	11	Ivory	Light Filtering	NA	NA	NA	NA
RD7	Claudio	12	Marble	Light Filtering	NA	NA	NA	NA
RB5	Claudio Blackout	10	Cotton	Light Filtering	NA	NA	NA	NA
RB5	Claudio Blackout	11	Ivory	Light Filtering	NA	NA	NA	NA
RB5	Claudio Blackout	12	Marble	Light Filtering	NA	NA	NA	NA
AB021	Cusco Blackout	01	Beige	Light Filtering	NA	NA	NA	NA
AB021	Cusco Blackout	03	Espresso	Light Filtering	NA	NA	NA	NA
AB021	Cusco Blackout	02	Warm Tan	Light Filtering	NA	NA	NA	NA
AF026	Delhi	02	Royal Navy	Light Filtering	NA	NA	NA	NA
AF026	Delhi	01	Westport Gray	Light Filtering	NA	NA	NA	NA
AB026	Delhi Blackout	02	Royal Navy	Blackout	NA	NA	NA	NA
AB026	Delhi Blackout	01	Westport Gray	Blackout	NA	NA	NA	NA
RD2	Drizzle	01	Flax	Light Filtering	NA	NA	NA	NA
RD2	Drizzle	05	Graphite	Light Filtering	NA	NA	NA	NA
RD2	Drizzle	04	Iron	Light Filtering	NA	NA	NA	NA
RD2	Drizzle	06	Moonstone	Light Filtering	NA	NA	NA	NA
AF037	Fuji	01	Pale Gold	Light Filtering	NA	NA	NA	NA
AF025	Heritage	02	Mountain Sage	Light Filtering	NA	NA	NA	NA
AF025	Heritage	01	Old Khaki	Light Filtering	NA	NA	NA	NA
AB025	Heritage Blackout	02	Mountain Sage	Blackout	NA	NA	NA	NA
AB025	Heritage Blackout	01	Old Khaki	Blackout	NA	NA	NA	NA

*See SOLAR OPTICAL INFORMATION section for detail.

SOLAR OPTICAL CHART

Collection Code	Collection Name	Color Code	Color Name	Openness Factor*	Transmission*	Reflection*	Absorption*	UV Rating*
AB036	Horizon Blackout	01	Crystal	Light Filtering	NA	NA	NA	NA
AB036	Horizon Blackout	02	Granite	Light Filtering	NA	NA	NA	NA
AB036	Horizon Blackout	03	Moss	Light Filtering	NA	NA	NA	NA
AF018	Juniper	02	Barley	Light Filtering	NA	NA	NA	NA
AF018	Juniper	04	Pacific Wash	Light Filtering	NA	NA	NA	NA
AF018	Juniper	03	Walnut	Light Filtering	NA	NA	NA	NA
AB018	Juniper Blackout	02	Barley	Light Filtering	NA	NA	NA	NA
AB018	Juniper Blackout	04	Pacific Wash	Light Filtering	NA	NA	NA	NA
AB018	Juniper Blackout	03	Walnut	Light Filtering	NA	NA	NA	NA
AF027	Lady Amherst	01	Alabaster	Light Filtering	NA	NA	NA	NA
AF027	Lady Amherst	02	Amore Pink	Light Filtering	NA	NA	NA	NA
AF027	Lady Amherst	05	Fair Haven	Light Filtering	NA	NA	NA	NA
AF027	Lady Amherst	06	Seabrook	Light Filtering	NA	NA	NA	NA
AF027	Lady Amherst	03	Silver	Light Filtering	NA	NA	NA	NA
AF027	Lady Amherst	04	Soft Sky	Light Filtering	NA	NA	NA	NA
AB027	Lady Amherst Blackout	02	Amore Pink	Blackout	NA	NA	NA	NA
AB027	Lady Amherst Blackout	05	Fair Haven	Blackout	NA	NA	NA	NA
AB027	Lady Amherst Blackout	06	Seabrook	Blackout	NA	NA	NA	NA
AB027	Lady Amherst Blackout	03	Silver	Blackout	NA	NA	NA	NA
AB027	Lady Amherst Blackout	04	Soft Sky	Blackout	NA	NA	NA	NA
AF033	Lavish	03	Autumn Sky	Light Filtering	NA	NA	NA	NA
AF033	Lavish	02	Shadow White	Light Filtering	NA	NA	NA	NA
AF033	Lavish	04	Silverlake	Light Filtering	NA	NA	NA	NA
AF033	Lavish	01	Snowfall	Light Filtering	NA	NA	NA	NA
R56	Linview	13	Ash	Light Filtering	NA	NA	NA	NA
R56	Linview	03	Cabana Wood	Light Filtering	NA	NA	NA	NA
R56	Linview	11	Fog	Light Filtering	NA	NA	NA	NA
R56	Linview	06	Macadamia	Light Filtering	NA	NA	NA	NA
R56	Linview	15	Midnight Black	Light Filtering	NA	NA	NA	NA
R56	Linview	02	Morning Light	Light Filtering	NA	NA	NA	NA
R56	Linview	10	Navy	Light Filtering	NA	NA	NA	NA
R56	Linview	14	New York Grey	Light Filtering	NA	NA	NA	NA
R56	Linview	09	Pale Lapis	Light Filtering	NA	NA	NA	NA
R56	Linview	17	Pale Oak	Light Filtering	NA	NA	NA	NA
R56	Linview	12	Porpoise	Light Filtering	NA	NA	NA	NA
R56	Linview	16	Sea Smoke	Light Filtering	NA	NA	NA	NA
R56	Linview	05	Slate	Light Filtering	NA	NA	NA	NA
R56	Linview	18	Soft Linen	Light Filtering	NA	NA	NA	NA
R56	Linview	01	Summer White	Light Filtering	NA	NA	NA	NA
R56	Linview	04	Weathered Walnut	Light Filtering	NA	NA	NA	NA
RB3	Linview Blackout	02	Alabaster	Light Filtering	NA	NA	NA	NA
RB3	Linview Blackout	03	Café Crème	Light Filtering	NA	NA	NA	NA
RB3	Linview Blackout	06	Colonnade Gray	Light Filtering	NA	NA	NA	NA
RB3	Linview Blackout	09	Gauntlet Gray	Light Filtering	NA	NA	NA	NA
RB3	Linview Blackout	07	Pale Gray	Light Filtering	NA	NA	NA	NA
RB3	Linview Blackout	11	Pale Oak	Light Filtering	NA	NA	NA	NA
RB3	Linview Blackout	01	Pure White	Light Filtering	NA	NA	NA	NA
RB3	Linview Blackout	10	Sea Smoke	Light Filtering	NA	NA	NA	NA
RB3	Linview Blackout	12	Soft Linen	Light Filtering	NA	NA	NA	NA
RB3	Linview Blackout	04	Stone	Light Filtering	NA	NA	NA	NA
RB3	Linview Blackout	05	Tranquility	Light Filtering	NA	NA	NA	NA
RB3	Linview Blackout	08	Whale	Light Filtering	NA	NA	NA	NA
RF4	Montero	201	Java Coast	Light Filtering	NA	NA	NA	NA
RF4	Montero	202	Wicker Basket	Light Filtering	NA	NA	NA	NA
AR041	Opulence Room Darkening	02	Champagne	Room Darkening	NA	NA	NA	NA
AR041	Opulence Room Darkening	01	Umber	Room Darkening	NA	NA	NA	NA
AF032	Pacific	01	Alabaster	Light Filtering	NA	NA	NA	NA
AF032	Pacific	02	Golden Oak	Light Filtering	NA	NA	NA	NA
AF032	Pacific	03	Gray Marble	Light Filtering	NA	NA	NA	NA
AF032	Pacific	04	Metallic Gray	Light Filtering	NA	NA	NA	NA
AB032	Pacific Blackout	01	Alabaster	Light Filtering	NA	NA	NA	NA
AB032	Pacific Blackout	02	Golden Oak	Light Filtering	NA	NA	NA	NA
AB032	Pacific Blackout	03	Gray Marble	Light Filtering	NA	NA	NA	NA
AB032	Pacific Blackout	04	Metallic Gray	Light Filtering	NA	NA	NA	NA

*See SOLAR OPTICAL INFORMATION section for detail.

SOLAR OPTICAL CHART

Collection Code	Collection Name	Color Code	Color Name	Openness Factor*	Transmission*	Reflection*	Absorption*	UV Rating*
AF017	Queenland	02	Bone	Light Filtering	NA	NA	NA	NA
AF017	Queenland	04	Buff	Light Filtering	NA	NA	NA	NA
AF017	Queenland	03	Dove Grey	Light Filtering	NA	NA	NA	NA
AF017	Queenland	01	Snow	Light Filtering	NA	NA	NA	NA
AB017	Queenland Blackout	02	Bone	Light Filtering	NA	NA	NA	NA
AB017	Queenland Blackout	04	Buff	Light Filtering	NA	NA	NA	NA
AB017	Queenland Blackout	03	Dove Grey	Light Filtering	NA	NA	NA	NA
AB017	Queenland Blackout	01	Snow	Light Filtering	NA	NA	NA	NA
RD21	Ranger	06	Charcoal	Light Filtering	NA	NA	NA	NA
RD21	Ranger	01	Chiffon	Light Filtering	NA	NA	NA	NA
RD21	Ranger	02	Pewter	Light Filtering	NA	NA	NA	NA
RD21	Ranger	05	White	Light Filtering	NA	NA	NA	NA
RB13	Ranger Blackout	06	Charcoal	Blackout	NA	NA	NA	NA
RB13	Ranger Blackout	01	Chiffon	Blackout	NA	NA	NA	NA
RB13	Ranger Blackout	02	Pewter	Blackout	NA	NA	NA	NA
RB13	Ranger Blackout	05	White	Blackout	NA	NA	NA	NA
AF038	Rhine	04	Black Pearl	Light Filtering	NA	NA	NA	NA
AF038	Rhine	03	Chamomile	Light Filtering	NA	NA	NA	NA
AF038	Rhine	02	Ivory	Light Filtering	NA	NA	NA	NA
AF038	Rhine	01	White	Light Filtering	NA	NA	NA	NA
RF3	Santa Cruz	101	Bunglehouse Blue	Blackout	NA	NA	NA	NA
RF3	Santa Cruz	100	Manchester	Light Filtering	NA	NA	NA	NA
RF3	Santa Cruz	106	Night Sky	Light Filtering	NA	NA	NA	NA
RF3	Santa Cruz	107	Rainforest	Light Filtering	NA	NA	NA	NA
RB1	Santa Cruz Blackout	02	Bunglehouse Blue	Light Filtering	NA	NA	NA	NA
RB1	Santa Cruz Blackout	01	Manchester	Blackout	NA	NA	NA	NA
RB1	Santa Cruz Blackout	04	Night Sky	Blackout	NA	NA	NA	NA
RB1	Santa Cruz Blackout	03	Rainforest	Blackout	NA	NA	NA	NA
R100	Scala Blackout	04	Silver	Blackout	NA	NA	NA	NA
R100	Scala Blackout	01	White	Blackout	NA	NA	NA	NA
AF039	Sequoia	01	Lace	Light Filtering	NA	NA	NA	NA
AF039	Sequoia	03	Mist	Light Filtering	NA	NA	NA	NA
AF039	Sequoia	02	Vanilla	Light Filtering	NA	NA	NA	NA
R11	Sheerweave 7000	01	Birch	Blackout	0	74	26	99%
R11	Sheerweave 7000	U67	Canvas	Blackout	0	73	27	99%
R11	Sheerweave 7000	V41	Canyon	Blackout	0	74	26	99%
R11	Sheerweave 7000	U69	Cocoa	Blackout	0	72	28	100%
R11	Sheerweave 7000	07	Graphite	Blackout	0	71	29	100%
R11	Sheerweave 7000	Q00	Merino	Blackout	0	72	28	100%
R11	Sheerweave 7000	02	Mushroom	Blackout	0	70	30	100%
R11	Sheerweave 7000	03	Onyx	Blackout	0	72	28	100%
R11	Sheerweave 7000	V70	Porpoise	Blackout	0	73	27	100%
R11	Sheerweave 7000	04	Sand	Blackout	0	73	27	100%
R11	Sheerweave 7000	Q57	Wheat	Blackout	0	75	25	100%
R11	Sheerweave 7000	06	White	Blackout	0	74	26	100%
P7200R	Sheerweave 7200R	RB2	Oyster	Blackout	NA	NA	NA	NA
P7200R	Sheerweave 7200R	RB1	Swan	Blackout	0	71	29	100%
P7200R	Sheerweave 7200R	RB7	Blazer	Blackout	NA	NA	NA	NA
P7200R	Sheerweave 7200R	RB4	Chiffon	Blackout	NA	NA	NA	NA
P7200R	Sheerweave 7200R	RB5	Chrome	Blackout	NA	NA	NA	NA
P7200R	Sheerweave 7200R	RB6	Earl Grey	Blackout	NA	NA	NA	NA
P7200R	Sheerweave 7200R	RB8	Raven	Blackout	0	71	29	100%
P7200R	Sheerweave 7200R	RB3	Sail	Blackout	NA	NA	NA	100%
P7250R	Sheerweave 7250R	RL2	Oyster	Light Filtering	NA	NA	NA	NA
P7250R	Sheerweave 7250R	RL1	Swan	Light Filtering	NA	NA	NA	NA
P7250R	Sheerweave 7250R	RL7	Blazer	Light Filtering	NA	NA	NA	NA
P7250R	Sheerweave 7250R	RL4	Chiffon	Light Filtering	NA	NA	NA	NA
P7250R	Sheerweave 7250R	RL5	Chrome	Light Filtering	NA	NA	NA	NA
P7250R	Sheerweave 7250R	RL6	Earl Grey	Light Filtering	NA	NA	NA	NA
P7250R	Sheerweave 7250R	RL8	Raven	Light Filtering	NA	NA	NA	NA
P7250R	Sheerweave 7250R	RL3	Sail	Light Filtering	NA	NA	NA	NA

*See SOLAR OPTICAL INFORMATION section for detail.

SOLAR OPTICAL CHART

Collection Code	Collection Name	Color Code	Color Name	Openness Factor*	Transmission*	Reflection*	Absorption*	UV Rating*
P7400	Sheerweave 7400	U80	Cotton	Blackout	0	64	36	NA
P7400	Sheerweave 7400	U81	Parchment	Blackout	NA	NA	NA	NA
P7400	Sheerweave 7400	U83	Pebble	Blackout	NA	NA	NA	NA
P7400	Sheerweave 7400	U87	Flint	Blackout	0	64	36	100%
P7400	Sheerweave 7400	U84	Seagrass	Blackout	NA	NA	NA	100%
P7400	Sheerweave 7400	U82	Sesame	Blackout	NA	NA	NA	100%
P7400	Sheerweave 7400	U85	Shale	Blackout	NA	NA	NA	100%
P7400	Sheerweave 7400	U86	Splce	Blackout	NA	NA	NA	100%
P7450	Sheerweave 7450	U80	Cotton	Light Filtering	NA	NA	NA	NA
P7450	Sheerweave 7450	U81	Parchment	Light Filtering	NA	NA	NA	NA
P7450	Sheerweave 7450	U83	Pebble	Light Filtering	NA	NA	NA	NA
P7450	Sheerweave 7450	U87	Flint	Light Filtering	NA	NA	NA	NA
P7450	Sheerweave 7450	U84	Seagrass	Light Filtering	NA	NA	NA	NA
P7450	Sheerweave 7450	U82	Sesame	Light Filtering	NA	NA	NA	NA
P7450	Sheerweave 7450	U85	Shale	Light Filtering	NA	NA	NA	NA
P7450	Sheerweave 7450	U86	Splce	Light Filtering	NA	NA	NA	NA
P7500	Sheerweave 7500	R39	Cloud	Blackout	NA	NA	NA	100%
P7500	Sheerweave 7500	R17	Dune	Blackout	NA	NA	NA	100%
P7500	Sheerweave 7500	R13	Ice	Blackout	0	68	32	100%
P7500	Sheerweave 7500	R41	Limestone	Blackout	NA	NA	NA	100%
P7500	Sheerweave 7500	R22	Midnight	Blackout	0	68	32	100%
P7500	Sheerweave 7500	R99	MidnightX2	Blackout	4	9	87	100%
P7500	Sheerweave 7500	R97	Mist	Blackout	NA	NA	NA	100%
P7500	Sheerweave 7500	R42	Nimbus	Blackout	NA	NA	NA	100%
P7500	Sheerweave 7500	R20	Odyssey	Blackout	NA	NA	NA	100%
P7500	Sheerweave 7500	S97	OrientX2	Blackout	4	13	83	100%
P7500	Sheerweave 7500	R21	Orient	Blackout	NA	NA	NA	100%
P7500	Sheerweave 7500	R40	Porcelain	Blackout	NA	NA	NA	100%
P7500	Sheerweave 7500	R19	Stone	Blackout	NA	NA	NA	100%
P7500	Sheerweave 7500	R43	Tundra	Blackout	NA	NA	NA	100%
P7500R	Sheerweave 7500R	R45	Cloud	Blackout	NA	NA	NA	100%
P7500R	Sheerweave 7500R	R51	Dune	Blackout	NA	NA	NA	100%
P7500R	Sheerweave 7500R	R44	Ice	Blackout	0	68	32	100%
P7500R	Sheerweave 7500R	R47	Limestone	Blackout	NA	NA	NA	100%
P7500R	Sheerweave 7500R	R55	Midnight	Blackout	0	68	32	100%
P7500R	Sheerweave 7500R	R48	Mist	Blackout	NA	NA	NA	100%
P7500R	Sheerweave 7500R	R49	Nimbus	Blackout	NA	NA	NA	100%
P7500R	Sheerweave 7500R	R53	Odyssey	Blackout	NA	NA	NA	100%
P7500R	Sheerweave 7500R	R54	Orient	Blackout	NA	NA	NA	100%
P7500R	Sheerweave 7500R	R46	Porcelain	Blackout	NA	NA	NA	100%
P7500R	Sheerweave 7500R	R52	Stone	Blackout	NA	NA	NA	100%
P7500R	Sheerweave 7500R	R50	Tundra	Blackout	NA	NA	NA	100%
P7700R	Sheerweave 7700R	TB1	Crystal	Blackout	0	70	30	NA
P7700R	Sheerweave 7700R	TB2	Sand	Blackout	0	57	43	NA
P7700R	Sheerweave 7700R	TB4	Chalk	Blackout	0	59	41	100%
P7700R	Sheerweave 7700R	TB3	Concrete	Blackout	0	44	56	NA
P7700R	Sheerweave 7700R	TB5	Graphite	Blackout	0	44	56	100%
P7700R	Sheerweave 7700R	TB7	Onyx	Blackout	0	6	94	100%
P7700R	Sheerweave 7700R	TB6	Pewter	Blackout	0	22	78	100%
P7750R	Sheerweave 7750R	TL3	Concrete	Light Filtering	NA	NA	NA	NA
P7750R	Sheerweave 7750R	TL1	Crystal	Light Filtering	NA	NA	NA	NA
P7750R	Sheerweave 7750R	TL2	Sand	Light Filtering	NA	NA	NA	NA
P7750R	Sheerweave 7750R	TL4	Chalk	Light Filtering	NA	NA	NA	NA
P7750R	Sheerweave 7750R	TL5	Graphite	Light Filtering	NA	NA	NA	NA
P7750R	Sheerweave 7750R	TL7	Onyx	Light Filtering	NA	NA	NA	NA
P7750R	Sheerweave 7750R	TL6	Pewter	Light Filtering	NA	NA	NA	NA
RF35	Sorrento	002	Bisque	Light Filtering	NA	NA	NA	NA
RF35	Sorrento	001	Linen	Light Filtering	NA	NA	NA	NA

*See SOLAR OPTICAL INFORMATION section for detail.

SOLAR OPTICAL CHART

Collection Code	Collection Name	Color Code	Color Name	Openness Factor*	Transmission*	Reflection*	Absorption*	UV Rating*
AF042	Urban	02	Cool Gray	Light Filtering	NA	NA	NA	NA
AF042	Urban	03	Latte	Light Filtering	NA	NA	NA	NA
AF042	Urban	01	Soft White	Light Filtering	NA	NA	NA	NA
AR042	Urban Room Darkening	02	Cool Gray	Room Darkening	NA	NA	NA	NA
AR042	Urban Room Darkening	03	Latte	Room Darkening	NA	NA	NA	NA
AR042	Urban Room Darkening	01	Soft White	Room Darkening	NA	NA	NA	NA
RD13	Vail	01	Grey	Light Filtering	NA	NA	NA	NA
RD13	Vail	02	Hazel	Light Filtering	NA	NA	NA	NA
RD13	Vail	03	Sage	Light Filtering	NA	NA	NA	NA
RD13	Vail	04	White	Light Filtering	NA	NA	NA	NA
RB19	Vail Blackout	01	Grey	Light Filtering	NA	NA	NA	NA
RB19	Vail Blackout	02	Hazel	Light Filtering	NA	NA	NA	NA
RB19	Vail Blackout	03	Sage	Light Filtering	NA	NA	NA	NA
RB19	Vail Blackout	04	White	Light Filtering	NA	NA	NA	NA
AF023	York	01	Almond	Light Filtering	NA	NA	NA	NA
AF023	York	04	Aluminum	Light Filtering	NA	NA	NA	NA
AF023	York	02	Dark Forest	Light Filtering	NA	NA	NA	NA
AF023	York	03	Parchment	Light Filtering	NA	NA	NA	NA
AB004	ZEN Blackout	02	Caramel	Blackout	NA	NA	NA	NA
AB004	ZEN Blackout	03	Iron	Blackout	NA	NA	NA	NA
AB004	ZEN Blackout	01	Pastel Gray	Blackout	NA	NA	NA	NA

*See **SOLAR OPTICAL INFORMATION** section for detail.